



CATALOGUE 2023



NOVEDADES NEWS NEW 2023



<p>GUISERA CON TAPA Round dish with lid</p>	<p>SVEA</p>	<p>SARTÉN fry pan</p>	<p>NEO BLUE</p>	<p>WOK wok</p>	<p>NATURA</p>
 <p>Pág. 10</p>	 <p>Pág. 25</p>	 <p>NEW 24 cms</p> <p>Pág. 32</p>			
<p>MOLDE DESMONTABLE springform mould</p>	<p>INOX</p>	<p>FUENTE RECTANGULAR CON TAPA rectangular dish with lid</p>	<p>CHURRERA - MAQUINA DE COOKIES cookie & churros gun</p>		
 <p>Pág. 96</p>	 <p>Pág. 108</p>	 <p>Pág. 128</p>			
<p>RASQUETA TRIANGULAR ECOPROF triangular scraper</p>	<p>RASQUETA TRIANGULAR triangular scraper</p>	<p>GUÍA CORTABIZCOCHOS EN CAPAS L layer cake slicing kit</p>			
 <p>Pág. 166</p>	 <p>Pág. 166</p>	 <p>Pág. 187</p>			

CAFETERA EXPRESS
espresso coffee maker

ELBA



Pág. 201

CAFETERA EXPRESS
espresso coffee maker

VENETO



Pág. 202

TETERA HIERRO FUNDIDO
Cast iron tea pot

IZUM



Pág. 205

TERMO SMART HYDRATE & REUSE
double wall thermo bottle



Pág. 223

VASO PORTAYOGUR-CEREALES
yoghurt and cereal cup



Pág. 231

EXPO BOWLS



Pág. 242

CONTENEDOR PARA CROQUETAS
container for croquettes



Pág. 245

TAPER PARA EMBUTIDOS Y FIAMBRES
container for deli meats and cold cuts



Pág. 245

CONTENEDOR DE ALIMENTOS RECTANGULAR
food container



Pág. 249

CONTENEDOR DE ALIMENTOS REDONDO
food container



Pág. 249

CONTENEDOR DE ALIMENTOS CUADRADO
food container



Pág. 249

PICADOR DE PEREJIL
parsley mill



Pág. 267

SOPORTE INOX PARA TACOS
taco holder



Pág. 277

POMO PARA TAPA DE CRISTAL
knob for glass cover



Pág. 296

TAPA PARA PLANCHA GRILL
contact grill cover

NEW
14 cms



Pág. 297

ALCUZA OLI D'OLIVA
oil can



Pág. 308

ACEITERA DE BOCA ANCHA BAENA
wide mouth oil dispenser



Pág. 309

FILTRO DE MALLA PARA FREGADERO
mesh sink strainer



Pág. 312

SET 6 PINCHOS PARA CARACOLES
set 6 skewers for snails



Pág. 315

PERFORADOR DE HUEVOS
egg piercer



Pág. 327

PIEDRA DE AFILAR COMBINADA
sharpening stone

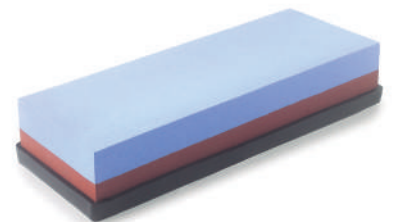

Pág. 330

AFILADOR PROFESIONAL 7 USOS
knife sharpener 7 usage



Pág. 331

MANOPLA REFORZADA
reinforced glove



Pág. 341

SERVIDOR PASTA DE MADERA
spaghetti server



Pág. 347

MAZO TENDERIZADOR
meat tenderiser



Pág. 347

ESPÁTULA PALETA RECTA INTENSE
straight spatula



Pág. 352

ESPÁTULA A PALA DE SILICONA INTENSE
silicone spatula



Pág. 352

BOTELLA RETRO
bottle retro



Pág. 364

JARRA
Pitcher

NEW
1,8 lts.



Pág. 364

PARRILLA RODABALLO INOX. L
fish wire grill L



Pág. 391

BOLSA ISOTÉRMICA
isothermal bag

NIZA



Pág. 387

BOLSA ISOTÉRMICA
isothermal bag

BIARRITZ



Pág. 388

CERAMIC BOWLS

JARDIN WHITE



HEXAGON WHITE



LAMAY



OSTROV



HEBAO



HALSON



GOTLAND



TALAI



ACUARIO



REBUN



KUME



LOTO



CERAMIC BOWLS

ALGARVE



COSTA NOVA



AVEIRO



HEXAGON RED



JARDIN BLUE



NAKURU



ELGON



ORMUZ



MENTHA



SAINT MALÓ



BIARRITZ



VENECIA



CUBO
utility pail/bucket

BLANCA



BORDEAUX



MUSGO



FRAISE



PECHE



PETROL



GRISE



PISTACHO



CIEL



Pág. 397

PLATO DE HUEVOS
egg dish

PECHE



PETROL



GRISE



PISTACHO



CIEL



FRAISE



Pág. 398

PLATO LLANO
dish plain

BORDEAUX

NEW
20 cms



Pág. 404

PLATO LLANO
dish plain

BLANCA

NEW
20 cms



Pág. 409

EXPO SARTENES COLUMNA
column exhibitor



Pág. 416

SINCE
1942.



UN GRAN PROYECTO EMPRESARIAL NACIDO EN 1942

Fiel a sus principales valores: innovación, diseño, adaptación al mercado, calidad en producto, servicio y honestidad, se debe ante todo a sus clientes, proveedores y al equipo humano que lo compone.

Propone en 2023 un catálogo con más de 3200 referencias disponibles en su recientemente ampliado almacén de 30.000 m², construido por el Grupo Marcos Larrañaga y Cía S.A. al que pertenece Ibili para, garantizar el mejor servicio al cliente.

AN EXTRAORDINARY BUSINESS PROJECT BORN IN 1942

Faithful to their principal values: Innovation, design, adapting to the market, high quality products and services and honesty, which they owe first and foremost to their clients, suppliers and the human team that makes the company up.

In 2023, they will be presenting a catalogue with more than 3200 items available from their recently expanded 30,000 m² warehouse built by the Grupo Marcos Larrañaga y Cía S.A. group, which Ibili is a member of, to guarantee the best customer service.

UN GRAND PROJET D'ENTREPRISE CRÉÉ EN 1942

Fidèle à ses principales valeurs, innovation, conception, adaptation au marché, qualité du produit et du service, et honnêteté, Ibili Menaje doit tout à ses clients, à ses fournisseurs, et à l'équipe qui la compose.

En 2023, la marque propose un catalogue de plus de 3 200 références disponibles dans son entrepôt de 30 000 m² récemment rénové, construit par le Groupe Marcos Larrañaga y Cía S.A. auquel appartient Ibili pour garantir le meilleur service à ses clients.

ALS GROSSES UNTERNEHMEN PRODUZIERT IBILI SEIT 1942

Innovative, modische und hochwertige Designerprodukte und bietet einen hervorragenden Kundendienst – all dies vor allen Dingen dank der ehrlichen Arbeit seiner Angestellten und Lieferanten.

Der Katalog für das Jahr 2023 enthält über 3100 Artikel aus unserem 30.000 m² großen Lager, das kürzlich von der Muttergesellschaft (Grupo Marcos Larrañaga & Cía S.A.) ausgebaut wurde.

UM GRANDE PROJETO EMPRESARIAL NASCIDO EM 1942

Fiel aos seus principais valores: inovação, design, adaptação ao mercado, qualidade dos produtos e de serviço e honestidade, orientado para a atenção aos clientes e fornecedores e à equipa humana que o compõe.

Para 2023, apresentamos um catálogo com mais de 3200 referências disponíveis no seu recentemente ampliado armazém, de 30000 m², construído pelo Grupo Marcos Larrañaga y Cía S.A, ao qual pertence Ibili, para oferecer o melhor serviço aos nossos clientes.



Ⓢ La empresa se reserva el derecho a cualquier modificación en fotografías, datos técnicos o precios.
La empresa no acepta devoluciones de piezas en buen estado sin previo acuerdo entre las partes.
Los abonos de las piezas en buen estado se realizará al 90% del precio al que se vendieron inicialmente.
Los costes del transporte de las piezas en buen estado se realizará a cargo del cliente.
Libre de BPA: Todos los artículos de éste catálogo están libres de BPA.

Ⓢ The company reserves the right to any modification of photos, technical information or prices.
The company does not accept returns of parts in good condition without previous agreement between both parties.
Credit of pieces in good condition will be for 90% of the price they were initially sold at.
Transport costs of the pieces in good condition will be the responsibility of the customer.
BPA FREE: All the items in this catalogue are BPA free

Ⓢ L'entreprise se réserve le droit à toutes modifications de photos, information technique ou prix.
La société n'accepte pas les retours de pièces en bon état sans accord préalable entre les parties.
Le remboursement des pièces en bon état sera de 90% du prix auquel elles ont initialement été vendues.
Les frais de transport des pièces en bon état seront à la charge du client.
Sans BPA: Tous les articles de ce catalogue sont exempts de BPA.
Les articles indiqués comme « POLYCARBONATE » dans les pages 110 à 113 sont interdit à la vente en France.

Ⓢ Änderungen an Fotografien, Spezifikationen und Preisen durch das Unternehmen vorbehalten.
Das Unternehmen akzeptiert Retouren mangelfreier Artikel nur nach vorherigem Einverständnis der Parteien.
Bei mangelfreien Artikeln wird 90 % des ursprünglichen Kaufpreises erstattet.
Die Versandkosten mangelfreier Artikel gehen zulasten des Kunden.
OHNE BPA: Alle Artikel in diesem Katalog sind frei von BPA.

Ⓢ A empresa reserva-se o direito de modificações de fotografias, informação técnica ou preços.
A empresa não aceita devoluções de peças em bom estado sem prévio acordo entre as partes.
O reembolso das peças em bom estado realizar-se-á por um montante correspondente a 90% do seu preço de venda inicial.
As despesas de transporte das peças em bom estado correrão a cargo do cliente.
BPA FREE (Artigos livres de BPA): Os artigos incluídos neste catálogo não contêm BPA.



4_ BATERÍAS

cookware / batteries de cuisine / Kochtopf-set / baterias de cozinha

22_ SARTENES-GRILLS / FREIDORAS / ACCESORIOS

frypans-grills / frying sets / accessories

poêles / grills / friteuses / accessoires

Pfannen-grills/ Fritteusen/ Zubehör

frigideiras / grelhadores / fritadeiras / acessórios

54_ PAELLERAS

“Paella” pans / plats à paëlla / Paellapfannen / paelheiras

60_ HORNO

roast pans / four / Backofen / forno

68_ REPOSTERÍA

bakeware / patisserie / Konditoreiwaren / pastelaria

198_ CAFETERÍA

coffee & tea / cafeteria / Kaffee & Tee / cafetaria

236_ VARIOS COCINA-MESA

kitchen-table / divers cuisine-table

Verschiedenes Küche/ Tisch / varios cozinha-mesa

418_ INDEX





baterías

cookware

batteries de cuisine

Kochtopf-set

baterias de cozinha

Neo	6
Excellent	7
Evolution	8
Noah	9
Svea	10
Oslo	11
Induktion	12
Prisma	13
Clásica	13
Sets	13
Cocotte	14
Natura	15
Copper	15
Inducta	16
Indubasic	17
Venus	17
Black	17
Volcán	18
Varios	18
Aluminio	21

Neo

ALUMINIO FUNDIDO INDEFORMABLE
UNDEFORMABLE CAST ALUMINIUM
FONTE D'ALUMINIUM INDEFORMABLE
FORMBESTÄNDIGER ALUMINIUMGUSS
ALUMINIO FUNDIDO INDEFORMÁVEL

special
induction

vitro

electric

gas

6 mm



Antiaderente 3 capas
Non stick 3 coats
Antiadhérent 3 couches
Antihaftbeschichtung 3 lagige
3 camadas de antiaderente

GUISERA CON TAPA

Round dish with lid
Plat rond avec couvercle
Kochtopf mit deckel
Tarteira com tampa

PPG **QuanTanium®**
Titanium-reinforced non-stick coating

~~PFOA~~

tapa de cristal borde silicona
glass lid, silicone ring



libili design

ref.	cms.	H	Lts	📦	Bar Code
464024	24	6,3	2,3	1/4	8411922458084
464028	28	7,2	3,7	1/4	8411922458091
464032	32	8,5	5,7	1/4	8411922458107
464036	36	8,8	7,4	1/2	8411922458114

CACEROLA CON TAPA

Casserole with lid
Faitout avec couvercle
Kasserolle mit deckel
Tacho com tampa

Asas de silicona
silicone handles

Full induction
máxima eficiencia
energética



ref.	cms.	H	Lts	📦	Bar Code
464120	20	8,5	2,2	1/4	8411922458121
464124	24	11,0	4,3	1/4	8411922458138
464128	28	12,5	6,4	1/2	8411922458145



Excellent titanio

ALUMINIO FUNDIDO INDEFORMABLE
UNDEFORMABLE CAST ALUMINIUM
FONTE D'ALUMINIUM INDEFORMABLE
ALLUMINIO FUSO INDEFORMABILE
ALUMINIO FUNDIDO INDEFORMÁVEL



GUISERA CON TAPA

round dish with lid
plat rond avec couvercle
tegame con coperchio
tarteira com tampa



Tapa de cristal borde silicona
glass lid, silicone ring



ref.	cms.	H	Lts	📦	Bar Code
462024	24	6	2,8	1/4	8411922439823
462028	28	6,5	4,2	1/4	8411922439830
462032	32	7,0	5,9	1/4	8411922439847
462036	36	7,5	8,0	1/4	8411922439854
462040	40	8,0	10,5	1/2	8411922439861



ibili design



CACEROLA CON TAPA

casserole with lid
faitout avec couvercle
casseruola c/coperchio
tacho com tampa

ref.	cms.	H	Lts	📦	Bar Code
462120	20	10,5	2,6	1/4	8411922439878
462124	24	11,4	4,2	1/4	8411922439885
462128	28	12,5	6,5	1/4	8411922439892

excellent titanio

MÁXIMA EFICIENCIA ENERGÉTICA
Aluminio fundido indeformable
INDUCCIÓN COMPLETA

MAXIMUM ENERGY EFFICIENCY
Undeformable cast aluminium
FULL INDUCTION

EFFICACITÉ ÉNERGÉTIQUE MAXIMALE
Fonte d'aluminium indéformable
FULL INDUCTION

MASSIMA EFFICIENZA ENERGETICA
Alluminio fuso indeformabile
FULL INDUCTION

MÁXIMA EFICIÊNCIA ENERGÉTICA
Alumínio fundido indeformável
FULL INDUCTION

Evolution

ALUMINIO FUNDIDO INDEFORMABLE
UNDEFORMABLE CAST ALUMINIUM
FONTE D'ALUMINIUM INDEFORMABLE
ALLUMINIO FUSO INDEFORMABILE
ALUMINIO FUNDIDO INDEFORMÁVEL

special
induction vitro electric gas 7 mm
Antiadherente 3 capas
Non stick 3 coats
Antiadhérent 3 couches
Antihafbeschichtung 3 lagige
3 camadas de antiaderente

GUISERA CON TAPA

round dish with lid
plat rond avec couvercle
Kochtopf mit Deckel
tarteira com tampa



tapa de cristal
Glass lid



ref.	cms.	H	Lts	☐	Bar Code
461024	24	7,5	2,8	1/6	8411922434729
461028	28	7,5	4,0	1/4	8411922434736
461030	30	8,5	4,6	1/2	8411922434743
461032	32	8,5	5,6	1/2	8411922434750
461036	36	8,5	7,5	1/2	8411922434767
461040	40	8,5	15	1/2	8411922436228

CACEROLA CON TAPA

casserole with lid
faitout avec couvercle
casseruola c/coperchio
tacho com tampa

Full induction
máxima eficiencia
energética



ref.	cms.	H	Lts	☐	Bar Code
461120	20	9	2,3	1/6	8411922434774
461124	24	11	4,2	1/4	8411922434781
461128	28	12,5	6,6	1/4	8411922434798



CAZO CON PICO
saucepan with spout
casserole avec bec verseur
casseruola con becco
caçarola com bico

ASAS silicona (2 pcs)

silicone handles
poignées silicone
manici in silicone
pegas de silicone



ref.	cms.	H	Lts.	☐	Bar Code
461216	16	8,5	1,4	1/6	8411922434804

ref.	cms.	☐	Bar Code	
461010	24..30	1/12	8411922436297	(2 pcs)
461011	32..36	1/12	8411922436303	(2 pcs)

evolution

MÁXIMA EFICIENCIA ENERGÉTICA
Aluminio fundido indeformable
INDUCCIÓN COMPLETA

MAXIMUM ENERGY EFFICIENCY
Undeformable cast aluminium
FULL INDUCTION

EFFICACITÉ ÉNERGÉTIQUE MAXIMALE
Fonte d'aluminium indéformable
FULL INDUCTION

MASSIMA EFFICIENZA ENERGETICA
Alluminio fuso indeformabile
FULL INDUCTION

MÁXIMA EFICIÊNCIA ENERGÉTICA
Alumínio fundido indeformável
FULL INDUCTION

Noah

ACERO INOXIDABLE 18/10. ASAS METÁLICAS
STAINLESS STEEL 18/10. METALIC HANDLES
INOX 18/10. ANSES MÉTALIQUES
INOX 18/10. MANIGLIE INOX
INOX 18/10. ASAS METÁLICAS



CACEROLA CON TAPA

casserole with lid
faitout avec couvercle
casseruola con coperchio
tacho com tampa



ref.	cms.	H	lts.	☐	Bar Code
605016	16	7,50	1,5	1/4	8411922088328
605018	18	8	2,0	1/4	8411922089257
605020	20	8,50	2,6	1/4	8411922088335
605022	22	8,50	3,2	1/4	8411922089264
605024	24	9	4,0	1/4	8411922088342
605026	26	9,50	5,0	1/4	8411922089271
605028	28	10	6,1	1/4	8411922088359
605032	32	12	9,6	1/4	8411922089288

OLLA CON TAPA

stockpot with lid
marmite avec couvercle
pentola con coperchio
panela com tampa



ref.	cms.	H	lts.	☐	Bar Code
605216	16	12,5	2,5	1/4	8411922088403
605218	18	13	3,3	1/4	8411922089301
605220	20	13,5	4,2	1/4	8411922088410
605222	22	14	5,3	1/4	8411922089318
605224	24	14,5	6,5	1/4	8411922088427
605226	26	15,5	8,2	1/4	8411922089325
605228	28	16,5	10,1	1/4	8411922088434
605232	32	17	13,7	1/4	8411922089332

CAZO

saucepan
casserole
casseruola 1 manico
caçarola



ref.	cms.	H	lts.	☐	Bar Code
605112	12	6	0,7	1/4	8411922089295
605114	14	7	1,0	1/4	8411922288366
605116	16	7,5	1,5	1/4	8411922288373
605118	18	9	2,3	1/4	8411922288380

GUISERA CON TAPA

round dish with lid
plat rond avec couvercle
tegame con coperchio
tarteira com tampa



ref.	cms.	H	lts.	☐	Bar Code
605318	18	4,5	1,2	1/4	8411922089349
605320	20	4,5	1,3	1/4	8411922089356
605322	22	4,7	1,4	1/4	8411922090383
605324	24	5	2,2	1/4	8411922288441
605326	26	5	2,4	1/4	8411922089363
605328	28	5,5	3,4	1/4	8411922288458
605332	32	6	4,8	1/4	8411922288465

OLLA SUPER ALTA CON TAPA

deep stockpot with lid
marmite traiteur avec couvercle
super hoher topf mit deckel
panela super alta com tampa

ref.	cms.	H	Lts	☐	Bar Code
605418	18	19	4.7	1/4	8411922441604
605420	20	20	6.2	1/2	8411922441611
605422	22	21,50	8,0	1/2	8411922441628
605424	24	22,50	10,0	1/2	8411922441635
605426	26	24	12.5	1	8411922441642
605428	28	25	15.1	1	8411922441659
605432	32	26	20,0	1	8411922441666



Svea

ACERO INOXIDABLE 18/10. ASAS BAQUELITA
 STAINLESS STEEL 18/10. BAKELITE HANDLES
 INOX 18/10. ANSES BAKELITE
 INOX 18/10. GRIFF AUS BAKELIT
 INOX 18/10. CABO BAQUELITE



GUISERA CON TAPA

Round dish with lid
 Plat rond avec couvercle
 Kochtopf mit deckel
 Tarteira com tampa

NEW

mango y asas baqueita
 Bakelite handles



ref.	cms.	H	lts.	📦	Bar Code
606320	20	4,50	1,30	1/8	8411922460391
606324	24	5,00	2,30	1/4	8411922470307
606328	28	5,50	3,40	1/4	8411922470314

CACEROLA CON TAPA

Casserole with lid
 Faitout avec couvercle
 Kasserolle mit Deckel
 Tacho com tampa



ref.	cms.	H	📦	Bar Code
606016	16	7,5	1/8	8411922456011
606020	20	8,5	1/4	8411922456035
606022	22	8,5	1/4	8411922456042
606024	24	9,0	1/4	8411922456059
606028	28	10,0	1/2	8411922456073

OLLA CON TAPA

Stock pot with lid
 Marmite avec couvercle
 Topf mit Deckel
 Panela com tampa



ref.	cms.	H	📦	Bar Code
606216	16	12,5	1/8	8411922456141
606220	20	13,5	1/4	8411922456165
606222	22	14,0	1/4	8411922456172
606224	24	14,5	1/4	8411922456189
606228	28	16,5	1/2	8411922456202

CAZO

Saucepan
 Casserole
 Stielkasserolle
 Caçarola

ref.	cms.	H	📦	Bar Code
606112	12	6,0	1/10	8411922456097
606114	14	7,0	1/8	8411922456103
606116	16	7,5	1/8	8411922456110



Oslo

ACERO INOXIDABLE 201, ASAS METÁLICAS INOX
STAINLESS STEEL 201. S/S METALLIC HANDLES
INOX 201. ANSES MÉTALLIQUES INOX
INOX 201. ASAS METÁLICAS INOX



CACEROLA BOMBADA CON TAPA

casserole, belly shape, with lid
faitout bombé avec couvercle
tacho abombado com tampa



ref.	cms.	lts.	📦	Bar Code
662016	16	1,50	1/6	8411922202793
662018	18	2,00	1/6	8411922068962
662020	20	2,50	1/6	8411922202809
662022	22	3,00	1/6	8411922205602
662024	24	3,50	1/4	8411922202816
662026	26	5,00	1/4	8411922068979
662028	28	6,50	1/4	8411922202823
662032	32	10,00	1/4	8411922204476

OLLA BOMBADA CON TAPA

stock pot, belly shape, with lid
marmite bombée avec couvercle
panela abombada com tampa



ref.	cms.	lts.	📦	Bar Code
662216	16	2,50	1/6	8411922202885
662220	20	4,50	1/6	8411922202892
662222	22	5,50	1/6	8411922205619
662224	24	6,50	1/4	8411922202908
662228	28	10,00	1/4	8411922202915

CAZO BOMBADO

saucepan, belly shape
casserole bombée
caçarola abombada



ref.	cms.	lts.	📦	Bar Code
662112	12	0,70	1/6	8411922202830
662114	14	1,00	1/6	8411922202847
662116	16	1,50	1/6	8411922202854

CACEROLA VAPOR BOMBADA CON TAPA

steam casserole, belly shape, with lid
faitout cuit vapeur bombé avec couvercle
tacho a vapor abombado com tampa



ref.	cms.	lts.	📦	Bar Code
663024	24	3,50	1/1	8411922203578

CESTILLO VAPOR

steam basket
panier vapeur
cesto vapor



ref.	cms.	📦	Bar Code
662524	24	1/4	8411922202946

OLLA PARA ESPÁRRAGOS + CESTILLO

Asparagus pot with basket
Cuit-asperges avec panier
Spargeltof
Panela para cozer espargos com cesto



ref.	Ø	Lts.	H.	📦	Bar Code
664016	16	4	22	1/6	8411922455571

Induktion

ACERO INOXIDABLE 18%. MANGO BAQUELITA
 STAINLESS STEEL 18%. BAKELITE HANDLE
 ACIER INOXYDABLE 18%. MANCHE BAKELITE
 ACCIAIO INOSSIDAVILE 18%. MANICO BACHELITE
 AÇO INOXIDÁVEL 18%. CABO BAQUELITE



CAZO
 saucepan
 casserole
 casseruola 1 manico
 caçarola

*soft touch
 tacto suave*



ref.	cms.	H	☞	Bar Code
666010	10	5,7	6/48	8411922438659
666012	12	6,2	6/48	8411922438666
666014	14	7,0	6/24	8411922438673
666016	16	7,7	6/24	8411922438680
666018	18	8,5	6/6	8411922438697
666020	20	8,8	6/6	8411922438703

PLATO PARA RACIONES INDUKTION
 serving plate
 plat à rations
 portionsteller
 prato para rações

loli design



ref.	cms.	H	☞	Bar Code
665814	14	3,3	6	8411922456899
665816	16	3,5	6	8411922456905
665818	18	3,8	6	8411922456912
665820	20	4,0	6	8411922456929
665824	24	4,5	6	8411922456936

CAZO CON TAPA DE CRISTAL
 saucepan with glass lid
 casserole avec couvercle en verre
 casseruola con coperchio in vetro
 caçarola com tampa de vidro



ref.	cms.	H	☞	Bar Code
666214	14	7,0	6/6	8411922439038

CAZO CON CESTILLO
 saucepan with basket
 casserole avec panier
 casseruola con cestello
 caçarola com cesto



ref.	cms.	H	☞	Bar Code
666118	18	8,5	6/6	8411922438758

HERVIDOR
 boiler
 pot cilindrique
 bollitore
 fervedor



ref.	cms.	H	☞	Bar Code
666310	10	10	6/24	8411922451764
666312	12	10	6/24	8411922439069
666314	14	11	6/24	8411922439076
666316	16	12	6/24	8411922439083

FREIDORA CON CESTILLO
 frying pan with basket
 friteuse avec panier
 fritteuse mit korb
 fritadeira com cesto



ref.	Cms	H.	Lts.	☞	Bar Code
666424	24	10	4,5	1/6	8411922448887

Prisma

ACERO INOX 18%
MANGO METÁLICO
STAINLESS STEEL 18%. METALLIC HANDLE
INOX 18%. MANCHE MÉTALLIQUE
INOX 18%. CABO METÁLICO



CAZO BOMBADO CON PICO

saucepan with spout, belly shape
casserole bombé avec bec verseur
caçarola abombada com bico



ref.	cms.	lts.	☐	Bar Code
665310	10	0,40	6/6	8411922068771
665312	12	0,60	6/6	8411922068788
665314	14	1,00	6/6	8411922068795
665316	16	1,50	6/6	8411922068801
665318	18	1,90	6/6	8411922068818

CAZUELITA INOX 18% PRISMA

round dish
plat rond
tacho baixo



ref.	cms.	H.	☐	Bar Code
665614	14	3,30	6/6	8411922076219
665616	16	3,50	6/6	8411922076226
665618	18	3,80	6/6	8411922076233

Clásica

ACERO INOX 18%
MANGO BAKELITA
STAINLESS STEEL 18%. BAKELITE HANDLE
INOX 18%. MANCHE BAKELITE
INOX 18%. CABO BAQUELITE



CAZO BOMBADO CON PICO

saucepan with spout, belly shape
casserole bombée avec bec verseur
caçarola abombada com bico



ref.	cms.	lts.	☐	Bar Code
665210	10	0,40	6/6	8411922161335
665212	12	0,60	6/6	8411922205831
665214	14	1,00	6/6	8411922205848
665216	16	1,50	6/6	8411922205855
665218	18	1,90	6/6	8411922208504
665220	20	2,40	6/6	8411922161342

Sets



BATERÍA 6 PIEZAS OPTIMA (tapas de cristal)

set 6 pieces (glass lids)
batterie 6 pièces (couvercle en verre)
trem de 6 peças (tampa de vidro)



cms.	lts.	☐	cms.	lts.
16	1,50	☐	14	1,20
18	2,00		16	1,50
20	2,50			
22	3,00			



ref.	☐	Bar Code
000957	1/4	8411922435580

Cocotte

HIERRO FUNDIDO ESMALTADO
VITRIFIED ENAMEL CAST IRON
FER FONTE ÉMAILLÉ
FERRO FUNDIDO ESMALTADO



COCOTTE REDONDA

round casserole
cocotte ronde
cocotte rotonda
tacho redondo



ref.	cms.	Lts.		Bar Code
725921R	21x10	2,7	1/4	8411922437294
725924R	24x11,5	3,9	1/2	8411922437300

MINI COCOTTE REDONDA

round mini casserole
mini cocotte ronde
mini cocotte rotonda
tacho mini redondo



ref.	cms.	lts.		Bar Code	
725910R	10x4,5	0,3	1/4	8411922082746	Red
725913R	13x8	0,5	1/6	8411922437287	Red
725910N	10x4,5	0,3	1/4	8411922082753	Black

COCOTTE OVAL

oval casserole
cocotte ovale
cocotte ovale
tacho oval



ref.	cms.	Lts.	H		Bar Code
726027R	27X21	3,3	10	1/2	8411922437317

MINI COCOTTE OVAL

oval mini casserole
mini cocotte ovale
mini cocotte ovale
tacho mini oval



ref.	cms.	lts.		Bar Code
726015R	15x10x6	0,5	1/4	8411922082760
726015N	15x10x6	0,5	1/4	8411922082777

Natura

ALUMINIO FORJADO PARA INDUCCIÓN
FORGED ALUMINIUM FOR INDUCTION
ALUMINIUM FORGÉ POUR INDUCTION
GESCHMIEDETES ALUMINIUM FÜR INDUKTIONSHERD
ALUMINIO FORJADO PARA INDUÇAO



special



induction



vitro



electric



gas



3 mm

CACEROLA CON TAPA

casserole with lid
faitout avec couvercle
casseruola con coperchio
tacho com tampa



ref.	cms.	H	lts.		Bar Code
440420	20	8,50	2,6	1/4	8411922093988
440422	22	9,50	2,9	1/6	8411922435993
440424	24	10,50	4,7	1/4	8411922093995
440428	28	12,0	6,4	1/6	8411922436006

OLLA CON TAPA

stockpot with lid
marmite avec couvercle
pentola con coperchio
panela com tampa



ref.	cms.	H	lts.		Bar Code
440520	20	13,00	4,0	1/4	8411922094008
440524	24	15,00	6,7	1/4	8411922094015

CAZO

saucepan
casserole
casseruola 1 manico
çaçarola



ANTIADHERENTE ESTILO PIEDRA
stone-style non-stick
antiadhesif façon pierre
antiaderente ala pietra
antiaderente estilo piedra

ref.	cms.	H	lts.		Bar Code
440614	14	6,5	1,0	1/6	8411922094022
440616	16	7,5	1,5	1/6	8411922094039

Copper

ALUMINIO FORJADO PARA INDUCCIÓN. MANGO ACERO INOX.
FORGED ALUMINIUM FOR INDUCTION. S/STEEL HANDLE
ALUMINIUM FORGÉ POUR INDUCTION.MANCHE INOX
GESCHMIEDETES ALUMINIUM FÜR INDUKTIONSHERD.STAHLSTIEL
ALUMINIO FORJADO PARA INDUÇAO.CABO INOX

special



induction



vitro



electric



gas



200°



3 mm

CACEROLA CON TAPA

casserole with lid
faitout avec couvercle
kasserolle mit decke
tacho com tampa

asas inox
s/steel handles



Antiaderente 3 capas
Non stick 3 coats
Antiadhérent 3 couches
Anitahftbeschichtung 3 lagige
3 camadas de antiaderente

ref.	Cms		Bar Code
495420	20x8,3	1/4	8411922442014
495424	24x10,4	1/4	8411922442021
495428	28x12,4	1/4	8411922442038

OLLA CON TAPA

stockpot with lid
marmite avec couvercle
topf mit deckel
panela com tampa



ref.	Cms		Bar Code
495520	20 X 12.9	1/4	8411922442045
495524	24 X 15.3	1/4	8411922442052

CAZO

saucepan
casserole
stielkasserolle
çaçarola



ref.	Cms	H.		Bar Code
495114	14,00	7,00	1/6	8411922441314
495116	16,00	7,50	1/6	8411922441321

Inducta

ALUMINIO PARA INDUCCION. MANGO BAQUELITA
ALUMINIUM FOR INDUCTION. BAKELITE HANDLE
ALUMINIUM POUR INDUCTION. MANCHE BAKELITE
ALUMÍNIO PARA INDUÇÃO. CABO BAQUELITE



Antiaderente 2 capas
Non stick 2 coats
Antiadhérent 2 couches
Antihaltbeschichtung 2 lagige
2 camadas de antiaderente

CACEROLA CON TAPA

casserole with lid
faitout avec couvercle
tacho com tampa



ref.	cms.	H.	lts.	☐	Bar Code
410816	16	7,5	1,5	1/4	8411922081022
410820	20	8,5	2,7	1/4	8411922081039
410824	24	9,0	4,0	1/4	8411922081046
410828	28	10	6,2	1/4	8411922081053

CAZO CON PICO

saucepan with spout
casserole avec bec verseur
caçarola com bico



ref.	cms.	H.	lts.	☐	Bar Code
411012	12	6	0,70	1/4	8411922081107
411014	14	7	1,10	1/4	8411922081114
411016	16	8	1,60	1/4	8411922081121
411018	18	9	2,30	1/4	8411922081138
411020	20	10	3,15	1/4	8411922081145

OLLA CON TAPA

stock pot with lid
marmite avec couvercle
panela com tampa



ref.	cms.	H.	lts.	☐	Bar Code
410916	16	12,5	2,50	1/4	8411922081060
410920	20	13,5	4,20	1/4	8411922081077
410924	24	14,5	6,50	1/4	8411922081084

HERVIDOR

boiler
pot cilindrique
wasser kocher
fervedor



ref.	cms.	lts.	☐	Bar Code
411414	14	1,8	6	8411922457094
411416	16	2,4	6	8411922457100

OLLA PARA PASTA

pasta pot
casserole pour pâtes
pastatopf
panela para cozer massa



ref.	cms.	H.	lts.	☐	Bar Code
411522	22	15,5	5,6	1/4	8411922449907

Indubasic

ALUMINIO PARA INDUCCION
ALUMINIUM FOR INDUCTION
ALUMINIUM POUR INDUCTION
ALUMÍNIO PARA INDUÇÃO



TARTERA INDUBASIC

round dish
plat rond
tacho baixo

ibili design



Antiaderente 2 capas
Non stick 2 coats
Antiadhérent 2 couches
Antihftbeschichtung 2 lagige
2 camadas de antiaderente



ref.	cms.	H.	☐	Bar Code
*405314	14	3,3	6/6	8411922076851
405316	16	3,5	6/6	8411922076868
405318	18	4,5	6/6	8411922081633
405320	20	4,5	6/6	8411922081640
405324	24	5	6/6	8411922081657

CAZO CON PICO + TAPA

sauce pan with spout + lid
casserole avec bec verseur + couvercle
caçarola com bico + tampa



ref.	cms.	lts.	H.	☐	Bar Code
406412	12	0,7	6	6/6	8411922085020

Venus

ALUMINIO. MANGO BAKELITA
ALUMINIUM. BAKELITE HANDLE
ALUMINIUM. MANCHE BAKELITE
ALUMÍNIO. CABO BAQUELITE



CAZO RECTO

saucepan
casserole
caçarola



ref.	cms.	lts.	☐	Bar Code
300214	14	0,90	6/6	8411922201147
300216	16	1,20	6/6	8411922201161

Black

ACERO ESMALTADO VITRIFICADO
VITRIFIED ENAMEL STEEL
ACIER ÉMAILLÉ VITRIFIÉ
STAHL EMAILLIERT
AÇO ESMALTADO VITRIFICADO



COCOTTE BLACK

oval roaster with lid
cocotte ovale avec couvercle
bräter mit deckel
cocotte oval com tampa



ref.	cms.	H	☐	Bar Code
914534	36x26	13	1	8411922455779
914538	38x28	15	1	8411922454734
914542	42x32	15	1	8411922454741

Volcán

ACERO ESMALTADO VITRIFICADO
VITRIFIED ENAMEL STEEL
ACIER ÉMAILLÉ VITRIFIÉ
AÇO ESMALTADO VITRIFICADO



CACEROLA CON TAPA, ASAS METÁLICAS

casserole with lid, metallic handles
faitout avec couvercle, anses métalliques
tacho com tampa, asas metálicas



ref.	cms.	lts.	📦	Bar Code
930116	16	1,50	6/6	8411922021165
930120	20	2,50	6/6	8411922021202
930124	24	4,50	6/6	8411922021240
930128	28	7,90	4/4	8411922021288

OLLA CON TAPA, ASAS METÁLICAS

stock pot with lid, belly shape, metallic handles
marmite bombée avec couvercle, anses métalliques
panela abombada com tampa, asas metálicas



ref.	cms.	H	lts.	📦	Bar Code
930216	16	11	2,00	6/6	8411922022162
930220	20	-	3,50	4/4	8411922022209
930224	24	15	6,00	4/4	8411922022247
930228	28	22	9,80	4/4	8411922022285

CAZO RECTO, MANGO BAKELITA

saucepan, bakelite handle
casserole, manche bakelite
caçarola, cabo baquelite



ref.	cms.	lts.	📦	Bar Code
930314	14	1,00	6/6	8411922023145
930316	16	1,50	6/6	8411922023169

Varios

ACERO ESMALTADO VITRIFICADO
VITRIFIED ENAMEL STEEL
ACIER ÉMAILLÉ VITRIFIÉ
AÇO ESMALTADO VITRIFICADO



CAZO PROMO

saucepan promo
casserole promo
caçarola promo



ref.	cms.	lts.	📦	Bar Code
912612	12	0,60	12/12	8411922065022
912614	14	0,90	12/12	8411922065015
912616	16	1,40	12/12	8411922065039

CAZO CÓNICO CON PICO MARRÓN

conical saucepan with spout (brown)
casserole conique avec bec verseur (brun)
caçarola conica com bico (castanha)



ref.	cms.	lts.	📦	Bar Code
915012	12	0,60	12/12	8411922012125
915014	14	0,90	12/12	8411922012149
915016	16	1,30	12/12	8411922012163
915018	18	1,80	12/12	841192207217

OLLA PARA MEJILLONES NEGRA "L"

mussel stockpot
marmite à moules
kochtopf für miesmuscheln
panela para cozer mexilhões



ref.	cms.		Bar Code
914622N	22	1/6	8411922454659

OLLA PARA MEJILLONES "M"

mussel stockpot
marmite à moules
kochtopf für miesmuscheln
panela para cozer mexilhões

NEGRA



PEACH



MENTA



PETROL



BERENJENA



TURQUESA



ref.	cms.		Bar Code
914618N	18	1/4	8411922451665
914618M	18	1/6	8411922452013
914618V	18	1/6	8411922452020
914618P	18	1/4	8411922451672
914618B	18	1/6	8411922456820
914618T	18	1/6	8411922456837

NEGRA
PEACH
MENTA
PETROL
BERENJENA
TURQUESA

ADAPTADOR INDUCCIÓN-VITROCERÁMICA ECO

induction-vitroc ceramic adapter eco
 adaptateur induction-vitrocéramique eco
 induktionsadapter-glaskeramik eco
 adaptador indução-vitrocêramica eco



Espesor 3,5 mm tricapa
 3,5 mm thickness triply



ref.	cms.	📦	Bar Code
705320	19,50	4/12	8411922451689
705324	23,50	4/12	8411922451696
705328	28,00	4/12	8411922451702

ADAPTADOR INDUCCIÓN PARA CAFETERAS

induction-vitroc ceramic adapter for coffee makers
 adaptateur induction-vitrocéramique pour cafetières
 induktionsadapter-glaskeramik für kaffeekoher
 adaptador indução-vitrocêramica para cafeteiras

Permite utilizar en fuegos de inducción CAFETERAS de fondo liso que no son aptas para inducción por sí solas. You can use flat bottom COFFEE POTS on induction cook tops that aren't suitable for induction by themselves.



mango baqueita
 bakeite handle

(bilibi design)



ref.	∅	📦	Bar Code
705312	12	4/12	8411922452426

ADAPTADOR INDUCCIÓN-VITROCERÁMICA

induction-vitroc ceramic adapter
 adaptateur induction-vitrocéramique
 adattatore induzione/vitroc ceramic
 adaptador indução-vitrocêramica



Espesor 5,5 - 6,5 mm capsulado
 5,5 - 6,5 mm thickness capsulated

ref.	cms.	📦	Bar Code
703714	14,50	4/12	8411922076875
703719	19	4/12	8411922068467
703724	24	4/12	8411922068474
703728	28	4/18	8411922075267

DIFUSOR PARA GAS

diffuser for gas
 diffuseur pour gazinières
 gasdiffusor
 difusor para gás

Reduce y distribuye el calor de forma uniforme en cocinas de gas y evita que los alimentos se quemen. Reduces and distributes heat evenly in gas stoves and prevents food from burning.



ref.	∅	📦	Bar Code
721221	21	6/48	8411922448979

CESTILLO PARA OLLA A PRESIÓN

basket for pressure cooker
panier pour autocuiseur
cestello per pentola a pressione
cesta para panela de pressão

INOX /
S. STEEL
18/10



ref.	Ø	H	📦	Bar Code
743221	21	11	1/4	8411922435689

CESTILLO PARA OLLA CON ASA

Stock pot basket with handle
Panier pour marmite avec anse
Körbchen für den kochtopf mit henkel
Cesto para panela com asa

INOX /
S. STEEL



ref.	Ø	H	📦	Bar Code
705510	14	10	1/6	8411922449525
705520	14	16	1/6	8411922449532
705530	16	16	1/6	8411922449549

Aluminio

ALUMINIO PULIDO
POLISHED ALUMINIUM
ALUMINIUM POLI
ALUMINIO POLIDO



CACEROLA HORNO, ASAS BAKELITA (caja individual)

roasting casserole bakelite handle (indiv. box)
faitout four, anses bakelite (boîte indiv.)
tacho forno, asas bakelita (caixa indiv.)



ref.	cms.	lts.	📦	Bar Code
100626	26	3,00	1/6	8411922101263
100628	28	3,50	1/6	8411922101287
100630	30	4,00	1/6	8411922101300
100632	32	4,80	1/6	8411922076844

BASE CACEROLA HORNO NIQUELADA

base for roasting casserole, nickel plated
support faitout-four niquelée
base tacho forno niquelada



ref.	📦	Bar Code
100600	1/24	8411922101003





sartenes grills

frypans-grills

poêles-grills

Pfannen-grills

frigideiras-grelhadores

Classe Titanium	24
Triply	24
Neo Blue	25
Quarzo	25
Titan	26
Evolution	27
New Ecologic	27
Titanio Chef	28
Luxe	29
Lif	30
New Essential	30
Basic Stone	30
Natura	31
Red Rock	33
Copper	34
Sanna	35
Bux	35
New Induplus	36
VitroCeramic	38
Fusión	38
I-Chef	40
Gastronomy	41
Inducta	42
Indubasic	44
Venus	47
Artika	47
Blinis	47
Moka	48
MiniAlu	49
Colorful	50
Korinto	51
Volcán	51
New Orange	51
Accesorios	52

Classe Titanium

ALUMINIO FUNDIDO INDEFORMABLE
UNDEFORMABLE CAST ALUMINIUM
FONTE D'ALUMINIUM INDEFORMABLE
ALLUMINIO FUSO INDEFORMABILE
ALUMINIO FUNDIDO INDEFORMÁVEL

special



SARTÉN
fry pan
poêle
padella
frigideira

Full induction
máxima eficiencia
energética



Antiaderente 3 capas
Non stick 3 coats
Antiadhérent 3 couches
Antihafbeschichtung 3 lagige
3 camadas de antiaderente

PPG **QuanTanium**
Titanium-reinforced non-stick coating



Classe TITANIUM

UN COLOR DE MANGO DIFERENTE PARA CADA MEDIDA
DIFFERENT COLOURED HANDLE FOR EACH SIZE

ref.	cms.	H	📦	Bar Code
507518	18	5,0	2/6	8411922453959
507520	20	5,0	2/6	8411922453966
507522	22	5,5	2/6	8411922453973
507524	24	5,5	2/6	8411922453980
507526	26	6,0	2/6	8411922453997
507528	28	6,0	2/6	8411922454000
507530	30	6,5	2/6	8411922454017



Triply

ACERO INOXIDABLE + ALUMINIO
S.STEEL + ALUMINIUM
INOX + ALUMINIUM
EDELSTAHL + ALUMINIUM
INOX + ALUMINIO

special



Antiaderente 3 capas
Non stick 3 coats
Antiadhérent 3 couches
Antihafbeschichtung 3 lagige
3 camadas de antiaderente

SARTÉN
fry pan
poêle
padella
frigideira

mango metáico
metallic handle

PPG **QuanTanium**
Titanium-reinforced non-stick coating



materia tricapa.
perfecta inducción
3 layer material.
perfect induction

3 CAPAS



DISTRIBUCIÓN UNIFORME Y EFICIENTE DEL CALOR EN TODA LA SUPERFICIE
UNIFORM AND EFFICIENT HEAT DISTRIBUTION OVER THE ENTIRE SURFACE

ref.	cms.	H	📦	Bar Code
652818	18	4,3	3/6	8411922458763
652820	20	4,5	3/6	8411922458770
652822	22	4,7	3/6	8411922458787
652824	24	5,0	3/6	8411922458794
652826	26	5,0	3/6	8411922458800
652828	28	5,4	3/6	8411922458817

Neo Blue

ALUMINIO FUNDIDO INDEFORMABLE
UNDEFORMABLE CAST ALUMINIUM
FONTE D'ALUMINIUM INDEFORMABLE
ALUMINIO FUSO INDEFORMABILE
ALUMINIO FUNDIDO INDEFORMÁVEL



SARTÉN
fry pan
poêle
padella
frigideira



NEW

soft touch
tacto suave

ibili design



Full induction
máxima eficiencia
energética

ref.	cms.	H	Lts.	📦	Bar Code
464218	18	4,5	0,8	2/6	8411922460049
464220	20	5,0	1,1	2/6	8411922460056
464222	22	5,3	1,5	2/6	8411922460063
464224	24	5,5	1,8	2/6	8411922460070
464226	26	5,5	2,2	2/6	8411922460087
464228	28	6,0	2,8	2/6	8411922460094

Quarzo

ALUMINIO FORJADO. MANGO METÁLICO
FORGED ALUMINIUM. METALLIC HANDLES
ALUMINIUM FORGÉ. ANSES MÉTALIQUES
GESCHMIEDETES ALUMINIUM. METALLISCHE STIEL
ALUMINIO FORJADO. CABO METÁLICO



Antiadherente 3 capas
Non stick 3 coats
Antiadhérent 3 couches
Antihftbeschichtung 3 lagige
3 camadas de antiaderente

SARTÉN
fry pan
poêle
padella
frigideira

mango remachado inox
s/steel riveted handle

Antiadherente
estio piedra
stone style non-stick



ref.	cms.	H	Lts.	📦	Bar Code
600018	18	4	1	3/6	8411922422009
600020	20	4	1	3/6	8411922422016
600022	22	5	2	3/6	8411922422023
600024	24	5	2	3/6	8411922422030
600026	26	5	3	3/6	8411922422047
600028	28	5	3	3/6	8411922422054
600030	30	6	4	3/6	8411922422061

Titan

ALUMINIO FUNDIDO, PARA INDUCCIÓN MANGO ACERO
 CAST ALUMINIUM FOR INDUCTION. S/STEEL HANDLE
 ALUMINIUM EN FONTE POUR INDUCTION. MANCHE INOX
 ALLUMINIO PER INDUZIONE. MANICO INOX
 ALUMINIO FUNDIDO PARA INDUÇÃO. CABO INOX



FUERZA, ERGONOMÍA Y SEGURIDAD

strength, safe and ergonomic
 solidité, sécurité et ergonomie
 forza, sicurezza ed ergonomia
 força, segurança e ergonomia



Antiaderente 3 capas
 Non stick 3 coats
 Antiadhérent 3 couches
 Antihafbeschichtung 3 lagige
 3 camadas de antiaderente



LOW CO₂ EMISSION



SARTÉN

fry pan
 poêle
 padella
 frigideira

Full induction
 máxima eficiencia
 energética



ref.	cms.	H	📦	Bar Code
465018	18	4,8	3/6	8411922433890
465020	20	5,3	3/6	8411922433906
465022	22	5,4	3/6	8411922433913
465024	24	5,5	3/6	8411922433920
465026	26	6,0	3/6	8411922433937
465028	28	6,0	3/6	8411922433944
465030	30	6,7	3/6	8411922433951
465032	32	6,5	2/4	8411922436334

CREPIERA

crepe pan
 poêle à crêpes
 krepp-pfanne
 frigideira de crepes

mango inox
 s/steel handle



ref.	cms.	H	📦	Bar Code
465222	22	2	3/6	8411922454505
465226	26	2	3/6	8411922436556

GRILL

grill
 grill
 bistechiera
 grelhador



ref.	cms.	H	📦	Bar Code
465123	23x23	4	3/6	8411922438574
465128	28x28	4	4/4	8411922436327

WOK



ref.	cms.	H		Bar Code
465330	30	9	2/4	8411922436563

Evolution

ALUMINIO FUNDIDO INDEFORMABLE
UNDEFORMABLE CAST ALUMINIUM
FONTE D'ALUMINIUM INDEFORMABLE
ALLUMINIO FUSO INDEFORMABILE
ALUMINIO FUNDIDO INDEFORMÁVEL

special



Antiaderente 3 capas
Non stick 3 coats
Antiadhérent 3 couches
Antihftbeschichtung 3 lagige
3 camadas de antiaderente

SARTEN

frypan
poêle
padella
frigideira



ibili design



ref.	cms.	H	Lts.		Bar Code
461318	18	4,5	0,8	3/6	8411922436358
461320	20	4,7	1,1	3/6	8411922436365
461322	22	5,0	1,4	3/6	8411922436372
461324	24	5,3	1,8	3/6	8411922436389
461326	26	5,5	2,3	3/6	8411922436396
461328	28	5,7	2,9	3/6	8411922436402
461330	30	6	3,4	3/6	8411922436419

New Ecologic

ACERO INOXIDABLE. MANGO BAKELITA
STAINLESS STEEL BAKELITE HANDLE.
INOX. MANCHE BAKELITE.
EDELSTAHL. GRIFF AUS BAKELIT
INOX. CABO BAKELITE



Antiaderente 2 capas
Non stick 2 coats
Antiadhérent 2 couches
Antihftbeschichtung 2 lagige
2 camadas de antiaderente



SARTEN

frypan
poêle
pfanne
frigideira

*soft touch
tacto suave*



ref.	cms.	H	Lts.		Bar Code
601514N	14	3,5	0,5	6	8411922441949
601518N	18	4,5	1,0	6	8411922441956
601520N	20	4,6	1,2	6	8411922441963
601522N	22	5,3	1,8	6	8411922441970
601524N	24	5,5	2,2	6	8411922441987
601526N	26	5,8	2,7	6	8411922441994
601528N	28	6,0	3,3	6	8411922442007

Titanio Chef

ALUMINIO FORJADO. MANGO METÁLICO. PROTECTOR SILICONA
 FORGED ALUMINIUM. METALLIC HANDLE. SILICONE PROTECTOR
 ALUMINIUM FORGÉ. MANCHE MÉTALLIQUE. POIGNÉE SILICONE
 ALUMINIO FORJADO. CABO METÁLICO. PROTECTOR SILICONA

special



SARTEN

frypan
 poêle
 padella
 frigideira



mando desmontable
 detachable handle



l'ibili design

ref.	cms.	H	📦	Bar Code
490022	22	5,4	6	8411922440317
490026	26	6,0	6	8411922440331
490028	28	6,0	6	8411922440348
490030	30	6,7	6	8411922440355
490032	32	6,5	4	8411922440362

FUNDA PROTECTOR PARA MANGO UNIVERSAL

handle saver for professional frying pan
 housse pour poêle professionnelle
 coprimanino per padella professionale
 capa para frigideira professional

100% SILICONE

Válido para la mayoría de mangos
 profesionales planos
 Valid for most flat professional handles

l'ibili design

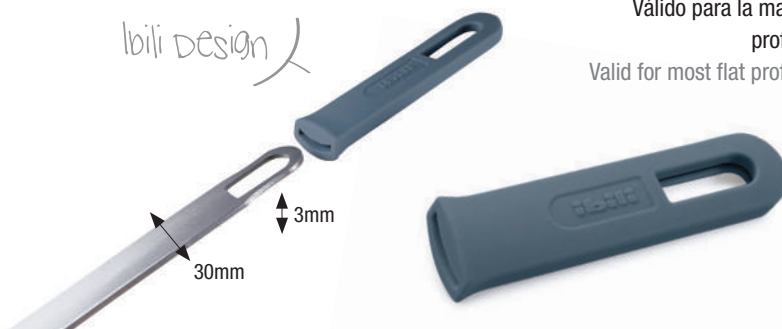

ref.	cms.	📦	Bar Code
490000	13	6	8411922441178

WOK PROFESIONAL

professional wok
 wok professionnelle
 gastronomie wok
 wok professional

Reforzado con titanio
 Reinforced titanium coating

Full induction
 máxima eficiencia
 energética



ref.	cms.	H	📦	Bar Code
490230	30	9,5	4	8411922446807

SARTÉN PROFESIONAL + TAPA VOLTEATORTILLAS

professional frying pan + omelette flipper lid
 poêle professionnelle + couvercle retourne omelette
 gastronomie-pfanne + tortilla-wendedeckel
 frigideira professional + tampa para voltear tortilhas



ref.	cms.	H		Bar Code
490126	26	6	4	8411922441758

Luxe

ALUMINIO FORJADO
 FORGED ALUMINIUM
 ALUMINIUM FORGE
 GESCHMIEDETES ALUMINIUM
 ALUMINIO FORJADO



WOK CON TAPA

Wok with lid
 Wok avec couvercle
 Wok mit Deckel
 Wok com tampa



ref.	cms.	H		Bar Code
404230	30	8,5-12	1/2	8411922454512

Lif

ALUMINIO FUNDIDO, PARA INDUCCIÓN
 CAST ALUMINIUM FOR INDUCTION
 ALUMINIUM EN FONTE POUR INDUCTION
 ALUMINIUMGUSS FÜR INDUKTIONSHERD
 ALUMINIO FUNDIDO PARA INDUÇAO.

special
 induction vitro electric gas 2,5 mm
 Antiaderente 3 capas
 Non stick 3 coats
 Antiadhérent 3 couches
 Antihaltbeschichtung 3 lagige
 3 camadas de antiaderente

GRILL
 Grill
 Grill
 Rost
 Grelhador



PPG Xylan® Plus
 Reliable long-life non-stick coating



~~PFOA~~

LISO - PLAIN - LISSE - LISCIA

ref.	cms.	H	📦	Bar Code
407020	20	3,4	6	8411922458374
407024	24	3,75	6	8411922458381
407028	28	3,85	6	8411922458398

ONDULADO - WAVED - AVEC RAINVERES - RIGATA

ref.	cms.	H	📦	Bar Code
407520	20	3,4	6	8411922458404
407524	24	3,75	6	8411922458411
407528	28	3,85	6	8411922458428

New Essential

ALUMINIO FUNDIDO INDEFORMABLE
 UNDEFORMABLE CAST ALUMINIUM
 FONTE D'ALUMINIUM INDEFORMABLE
 ALLUMINIO FUSO INDEFORMABILE
 ALUMINIO FUNDIDO INDEFORMÁVEL

special
 induction vitro electric gas 5 mm

GRILL-PLANCHA
 grill-plate
 grill-plancha
 grill-piastra
 grelhador-chapas

asas de silicona
 silicone handles

loili design

PPG Xylan® ~~PFOA~~



ref.	cms.	H	📦	Bar Code
409127	27x24	2	4	8411922454116
409133	33x24	2	4	8411922454123

Basic Stone

ALUMINIO FUNDIDO, PARA INDUCCIÓN
 CAST ALUMINIUM FOR INDUCTION
 ALUMINIUM EN FONTE POUR INDUCTION
 ALLUMINIO PER INDUZIONE
 ALUMINIO FUNDIDO PARA INDUÇAO

special
 induction vitro electric gas 5 mm
 FONDO DE AÇÚCAR
 SUGAR BOTTOM
 FONDU DE SUCRE
 FONDINO BICO: 18%

GRILL-PLANCHA LISO
 grill-plate plain
 grill-plancha lisse
 grill-piastra liscia
 grelhador-chapas liso



ref.	cms.	H	📦	Bar Code
409523	36x23	3,2	1/6	8411922435054
409529	47x29	3,7	1/6	8411922435061

GRILL-PLANCHA ONDULADO
 waved grill-plate
 grill-plancha ave rainures
 grill-piastra rigata
 grelhador-chapas ondulado

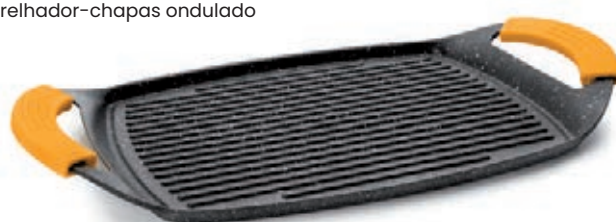

ref.	cms.	H	📦	Bar Code
406023	36x23	3,7	1/6	8411922437195
406029	47x29	3,7	1/6	8411922437201

Natura

ALUMINIO PARA INDUCCIÓN
ALUMINIUM FOR INDUCTION
ALUMINIUM POUR INDUCTION
ALUMINIO PER INDUZIONE
ALUMINIO PARA INDUÇÃO

special



induction



vitro



electric



gas



5 mm



4 mm



Antiaderente 2 capas
Non stick 2 coats
Antiadhérent 2 couches
Antihftbeschichtung 2 lagige
2 camadas de antiaderente

SARTEN

fry pan
poêle
padella
frigideira



ANTIADHERENTE ESTILO PIEDRA

stone-style non-stick
antiadhesif façon pierre
antiaderente ala pietra
antiaderente estilo piedra



ref.	cms.	H	📦	Bar Code
* 440014	14	4	12/24	8411922091380
440016	16	4,4	6/6	8411922433777
440018	18	4,1	6/6	8411922089646
440020	20	4,5	6/6	8411922089653
440022	22	4,7	6/6	8411922089660
440024	24	5	6/6	8411922089677
440026	26	5,3	6/6	8411922089684
440028	28	5,5	6/6	8411922089691
440030	30	5,7	6/6	8411922089707

CREPIERA 7 MINICREPES

7 mini crepes pan
poêle à 7 mini crêpes
7 mini krepp-pfanne
sertã de 7 mini crepes

Con receta
With recipe
Avec recette
Con ricetta
Com receita

emojis



ref.	cms.	Ø	H	📦	Bar Code
400207	26	8	1,5	6	8411922448559

CREPIERA 4 MINICREPES/ HUEVOS

4 Mini crepes pan/ eggs
Poêle à 4 mini crêpes/ œufs
4 mini Krepp-Pfanne/ eier
Sertã de 4 mini crepes/ ovos

isos



ref.	cms.	Ø	H	📦	Bar Code
400204	26	10	1,5	6	8411922448542

CREPIERA 6 MINICREPES CORAZÓN

6 mini crepes pan Heart
poêle à 6 mini crêpes Coeur
6 mini krepp-pfanne Herzförmig
sertã de 6 mini crepes Coração

Con receta
With recipe
Avec recette
Con ricetta
Com receita



aluminio fundido
cast aluminium

ref.	cms.	H	📦	Bar Code
400206	28	1,5	6	8411922457797

SARTÉN HONDA CON MANGO

deep fry pan
poêle profonde
padella profonda
frigideira funda



ref.	cms.	H.	📦	Bar Code
440724	24	6,5	6/6	8411922094046
440728	28	7,5	6/6	8411922094053

SARTÉN HONDA CON ASAS

deep fry pan with handle
poêle profonde avec anses
padella profonda con 2 maniglie
frigideira funda com asas



ref.	cms.	H.	📦	Bar Code
440828	28	7,5	4/4	8411922094060
440832	32	7,8	4/4	8411922094077

SARTEN TORTILLAS

omelette pan
poêle a omelette
frigideira dupla

bilili design

*Full induction
máxima eficiencia
energética*



Con receta
With recipe
Avec recette
Con ricetta
Com receita

ref.	cms.	H.	📦	Bar Code
441020	20	9,3	4/4	8411922435283
441024	24	9,5	4/4	8411922435290

CREPIERA

crepe pan
poêle à crêpes
padelle per crepes
frigideira de crepes

*Full induction
máxima eficiencia
energética*

Crêpes / Filloas

Con receta
With recipe
Avec recette
Con ricetta
Com receita



ref.	cms.	H.	📦	Bar Code
440225	25	2,00	6/6	8411922091595
440228	28	2,00	6/6	8411922091601

GRILL

grill
grill
bistechiera
grelhador



ref.	cms.	H.	📦	Bar Code
440128	28x28	4,5	6/6	8411922091397

WOK

wok
wok
wok



ref.	cms.	H.	Lts	📦	Bar Code
441124	24	7	2,3	6	8411922459746
441130	30	9	3,7	6	8411922441383

NEW

Red Rock

ALUMINIO FORJADO. MANGO METÁLICO
 FORGED ALUMINIUM. METALLIC HANDLES.
 ALUMINIUM FORGÉ. ANSES MÉTALIQUES.
 GESCHMIEDETES ALUMINIUM. METALLISCHE STIEL.
 ALUMINIO FORJADO. CABO METÁLICO.



Ultraresistente. Maxima eficiencia energética
 Superficie rugosa reforzada por impacto de bolas de acero
 Ultra resistant. Maximum energy efficiency
 Reinforced textured surface by ball impact technology



SARTEN
 frypan
 poêle
 pfanne
 sertã

estilo piedra
 stone style



Especial Inducción
 Full Induction

mango remachado
 riveted handle

ref.	cms.	H	📦	Bar Code
515018	18	4,1	6	8411922449457
515020	20	4,2	6	8411922449464
515022	22	4,5	6	8411922449471
515024	24	4,6	6	8411922449488
515026	26	4,8	6	8411922449495
515028	28	5,20	6	8411922449501
515030	30	5,30	6	8411922449518

GRILL
 grill
 grill
 bistechiera
 grelhador

mango inox
 s/steel handle



ref.	cms.	H	📦	Bar Code
515128	28x28	6,50	3/6	8411922452037

SARTÉN HONDA CON MANGO
 deep fry pan
 poêle profonde
 padella profonda
 frigideira funda



ref.	cms.	H	📦	Bar Code
515224	24	6,50	3/6	8411922452044
515228	28	7,50	3/6	8411922452051

SARTÉN HONDA CON ASAS
 deep fry pan with handle
 poêle profonde avec anses
 padella profonda con 2 maniglie
 frigideira funda com asas

asas inox
 s/steel handles



ref.	cms.	H	📦	Bar Code
515328	28	7,50	3/6	8411922452068
515332	32	7,50	3/6	8411922452075

Copper

ALUMINIO PARA INDUCCIÓN. MANGO ACERO INOX.
ALUMINIUM FOR INDUCTION. S/STEEL HANDLE
ALUMINIUM POUR INDUCTION.MANCHE INOX
ALUMINIUMGUSS FÜR INDUKTIONSHERD.STAHLSTIEL
ALUMINIO PARA INDUÇÃO.CABO INOX



SARTEN

frypan
poêle
pfanne
frigideira

Antiaderente 3 capas
Non stick 3 coats
Antiadhérent 3 couches
Antihftbeschichtung 3 lagige
3 camadas de antiaderente



Full induction
máxima eficiencia
energética



ref.	Cms	H.	📦	Bar Code
495016	16,00	4,00	6	8411922441239
495018	18,00	4,00	6	8411922441246
495020	20,00	4,20	6	8411922441253
495022	22,00	4,20	6	8411922441260
495024	24,00	4,70	6	8411922441277
495026	26,00	5,00	6	8411922441284
495028	28,00	5,00	6	8411922441291
495030	30,00	5,00	6	8411922441307

SARTEN HONDA

deep fry pan
poêle profonde
tiefe bratpfanne
frigideira funda



ref.	Cms	H.	📦	Bar Code
495324	24,00	7,00	6	8411922441345
495328	28,00	7,50	6	8411922441352

GRILL

grill
grill
rost
grelhador



ref.	Cms	H.	📦	Bar Code
495228	28x28	4,20	6	8411922441338

SARTEN HONDA CON ASAS

deep fry pan with handle
poêle profonde avec anses
tiefe bratpfanne mit henkeln
frigideira funda com asas



ref.	Cms	📦	Bar Code
495628	28x7,5	4	8411922442069
495632	32x7,8	4	8411922442076

Sanna

ALUMINIO FORJADO PARA INDUCCIÓN
 FORGED ALUMINIUM FOR INDUCTION
 ALUMINIUM FORGÉ POUR INDUCTION
 GESCHMIEDETES ALUMINIUM FÜR INDUKTIONSHERD
 ALUMINIO FORJADO PARA INDUÇÃO

special

 Antiadherente 2 capas
 Non stick 2 coats
 Antiaçherent 2 couches
 Anhaftbeschichtung 2 lagige
 2 camadas de antiaderente

SARTÉN
 fry pan
 poêle
 padella
 frigideira



Full induction
 máxima eficiencia
 energética

mango baqueita – tacto suave
 bakelite handle – soft touch

PPG Xylan® Plus
 Reliable long-life non-stick coating

ref.	cms.	H		Bar Code
482518	18	4,3	6/6	8411922458664
482520	20	4,5	6/6	8411922458671
482522	22	4,7	6/6	8411922458688
482524	24	5,0	6/6	8411922458695
482526	26	5,5	6/6	8411922458701
482528	28	5,5	6/6	8411922458718
482530	30	5,8	6/6	8411922458725

Bux

ALUMINIO. MANGO BAKELITA
 ALUMINIUM. BAKELITE HANDLE
 ALUMINIUM. MANCHE BAKELITE
 ALUMINIUM. GRIFF AUS BAKELIT
 ALUMINIO. CABO BAKELITE

BUX
 PFOA free BPA free

special

 Antiadherente 2 capas
 Non stick 2 coats
 Antiaçherent 2 couches
 Anhaftbeschichtung 2 lagige
 2 camadas de antiaderente

SARTEN
 frypan
 poêle
 pfanne
 sertã

Soft touch
 tacto suave



PPG Xylan®

Full induction
 máxima eficiencia
 energética

ref.	cms.	H		Bar Code
505016	16	4,0	6	8411922452877
505018	18	4,4	6	8411922452874
505020	20	4,4	6	8411922452891
505022	22	4,9	6	8411922452907
505024	24	5,0	6	8411922452914
505026	26	5,4	6	8411922452921
505028	28	5,9	6	8411922452938
505030	30	5,9	6	8411922452945

SARTEN DOBLE PARA TORTILLAS

Double fry pan for spanish omelette
 Poêle double a omelette
 Tortilla -Doppelpfanne
 Sertã dupla para tortilha



ref.	cms.	H		Bar Code
505220	20	5,4+4,4	4	8411922457803
505224	24	5,5+4,5	4	8411922457810

GRILL

grill
 grill
 bistechiera
 grelhador



ref.	cms.	H		Bar Code
505126	26X26	4,5	6	8411922457070

New Induplus

ALUMINIO, PARA INDUCCION. MANGO BAQUELITA
 ALUMINIUM FOR INDUCTION. BAKELITE HANDLE
 ALUMINIUM POUR INDUCTION. MANCHE BAKELITE
 ALUMÍNIO PARA INDUÇÃO. CABO BAQUELITE



SARTEN

frypan
 poêle
 padella
 frigideira

soft touch

Full induction
 máxima eficiencia
 energética



ref.	cms.	H	☐	Bar Code
400016N	16	4,4	6/6	8411922436037
400018N	18	4,7	6/6	8411922436044
400020N	20	5,0	6/6	8411922436051
400022N	22	5,3	6/6	8411922436068
400024N	24	5,6	6/6	8411922436075
400026N	26	5,9	6/6	8411922436082
400028N	28	6,2	6/6	8411922436099
400030N	30	6,5	6/6	8411922436105



GRILL

grill
 grill
 bistechiera
 grelhador



ref.	cms.	H	Lts.	☐	Bar Code
400328N	28	5	2,1	6/6	8411922437805

FREIDORA CON CESTILLO

frying set with basket
 friteuse avec panier
 padella per friggere
 con cestello
 fritadeira com
 cesto



ref.	Cms.	H	☐	Bar Code
400826N	26	8,0	6/6	8411922438734

SARTEN HONDA

deep fry pan
 poêle profonde
 tiefe bratpfanne
 frigideira funda



ref.	cms.	H	Lts.	☐	Bar Code
400124N	24	7	2,60	6	8411922447576
400128N	28	7,5	3,80	6	8411922447583

WOK

wok
 wok
 wok



ref.	Cms.	H	Lts.	☐	Bar Code
400528N	28	8	3,6	6	8411922447590

SARTÉN + TAPA VOLTEATORTILLAS

frying pan + omelette flipper lid
poêle + couvercle retourne omelette
pfanne + tortilla-wendedeckel
sertä + tampa para voltear tortilhas

Especial tortillas
Specially made for spanish omelettes
Spéciale tortillas
Speziell für tortillas
Especial para tortilhas

ibili design



Inducción completa
Full induction

ref.	Ø	H.	📦	Bar Code
400626N	26	7	4	8411922452501

GRILL

Grill
Grill
Rost
Grelhador



Inducción completa
Full induction

ref.	Cms.	H	📦	Bar Code
400318N	18x18	4	6	8411922456233

CREPIERA NEW INDUPLUS

crepe pan
poêle à crêpes
krepp-pfanne
frigideira de crepes



ref.	cms.	H	📦	Bar Code
400428N	28	2	6	8411922457087

WOK

wok
wok
wok



ref.	cms.	H	📦	Bar Code
400528	28	8	6/6	8411922081626

VitroCeramic

ALUMINIO. MANGO BAKELITA.
ALUMINIUM. BAKELITE HANDLE.
ALUMINIUM. MANCHE BAKELITE.
ALUMINIUM. GRIFF AUS BAKELIT.
ALUMINIO. CABO BAKELITE.

special



vitro



electric



gas



3,5 mm



Antiaderente 2 capas
Non stick 2 coats
Antiadhérent 2 couches
Anitahbeschichtung 2 lagige
2 camadas de antiaderente

SARTEN

frypan
poêle
pfanne
sertã



TACTO SUAVE
SOFT TOUCH



La sartén VITRO-CERAMIC está pensada y diseñada para obtener el máximo rendimiento específicamente en cocinas de VITROCERAMICA.

The VITRO-CERAMIC frying pan is intended and designed to obtain maximum performance specifically on GLASS CERAMIC hobs.

ref.	cms.	H	📦	Bar Code
325018	18	4,0	6	8411922449327
325020	20	4,5	6	8411922449334
325022	22	4,5	6	8411922449341
325024	24	5,0	6	8411922449358
325026	26	5,0	6	8411922449365
325028	28	5,8	6	8411922449372
325030	30	6,0	6	8411922449389

Fusión

ALUMINIO PARA INDUCCIÓN. MANGO BAKELITA
ALUMINIUM FOR INDUCTION. BAKELITE HANDLE
ALUMINIUM POUR INDUCTION. MANCHE BAKELITE
ALLUMINIO PER INDUZIONE. MANICO BACHELITE
ALUMINIO PARA INDUÇÃO. CABO BAQUELITE

special



induction

special



vitro



electric



gas



3 mm

Antiaderente 2 capas
Non stick 2 coats
Antiadhérent 2 couches
Anitahbeschichtung 2 lagige
2 camadas de antiaderente

SARTEN

frypan
poêle
padella
frigideira



TACTO SUAVE
SOFT TOUCH



ref.	cms.	H	📦	Bar Code
450016	16	4,00	6/12	8411922092363
450018	18	4,20	6/12	8411922092370
450020	20	4,30	6/12	8411922092387
450022	22	4,70	6/12	8411922092394
450024	24	5,00	6/12	8411922092400
450026	26	5,50	6/12	8411922092417
450028	28	5,80	6/12	8411922092424
450030	30	5,80	6/12	8411922092431

LOTE SARTÉN FUSIÓN 20+24 cm

20 + 24 cm fry pan set Fusion
lot 2 poêles 20 + 24 Fusion
Set 2 padelle 20 + 24 Fusion
Jogo 2 frigideiras Fusion



ref.	cms.		Bar Code
450100	20+24	6/6	8411922093810

GRILL

grill
grill
bistechiera
grelhador



ref.	cms.	H		Bar Code
450226	26x26	4	6/6	8411922436570

SARTÉN HONDA CON MANGO

deep fry pan
poêle profonde
padella profonda
frigideira funda



ref.	cms.	H.		Bar Code
450820	20	7,00	6	8411922451559
450824	24	7,70	6	8411922451566
450826	26	7,80	6	8411922451573
450828	28	8,10	6	8411922451580

SARTEN HONDA CON ASAS

deep fry pan with handle
poêle profonde avec anses
tiefe bratpfanne mit henkeln
frigideira funda com asas



ref.	cms.	H.		Bar Code
450924	24	7,70	6	8411922451597
450928	28	8,10	6	8411922451603
450932	32	8,40	6	8411922451610
450936	36	10,00	6	8411922451627

FREIDORA

frying pan
friteuse
fritteuse
fritadeira

cestiño inox
s-steel basket



ref.	cms.	H.		Bar Code
451026	26	7,80	6	8411922451634

CREPIERA
 crepes pan
 poêle à crêpes
 krepp-pfanne
 sertã de crepes

Con receta
 With recipe
 Avec recette
 Con ricetta
 Com receita

CRÊPES/FILLOAS



Fondo acero inox 18%
 s/steel botton 18%

ref.	cms.	H	📦	Bar Code
451222	22	1,5	6	8411922452372
451226	26	2,0	6	8411922452389

SARTÉN PARA TORTILLAS

omelette pan
 poêle à omelette
 tortilla-pfanne
 sertã para tortilhas

loli design



ref.	cms.	H	📦	Bar Code
451320	20	9,0	4	8411922452396
451324	24	9,5	4	8411922452402

I-Chef

ALUMINIO PARA INDUCCION. MANGO INOX
 ALUMINIUM FOR INDUCTION. S/STEEL HANDLE
 ALUMINIUM POUR INDUCTION. MANCHE INOX
 ALUMÍNIO PARA INDUÇÃO. CABO INOX



Antiaderente 2 capas
 Non stick 2 coats
 Antiadhérent 2 couches
 Antihärtschichtung 2 lagige
 2 camadas de antiaderente

SARTEN

fry pan
 poêle
 frigideira



ref.	cms.	H.	📦	Bar Code
403018	18	4	6/6	8411922082975
403020	20	4,5	6/6	8411922082982
403022	22	5	6/6	8411922082999
403024	24	5	6/6	8411922083002
403026	26	5,5	6/6	8411922083019
403028	28	6	6/6	8411922083026
403030	30	6	6/6	8411922083033
403032	32	6,5	6/6	8411922083040
403036	36	6,5	4/4	8411922436341

SARTÉN HONDA CON MANGO

deep fry pan
põele profunde
frigideira funda



ref.	cms.	H.	📦	Bar Code
403124	24	7,70	6/6	8411922083897
403128	28	8,10	6/6	8411922083903
*403132	32	8,40	6/6	8411922083910

SARTÉN HONDA CON ASAS

deep fry pan with handles
põele profunde avec anses
frigideira funda com asas



* No inducción

ref.	cms.	H.	📦	Bar Code
403328	28	8,10	6/6	8411922083941
403332	32	8,40	6/6	8411922083958
403336	36	10,00	6/6	8411922083965
*403340	40	12,00	4/6	8411922083972

Gastronomy

ALUMINIO. MANGO DE ACERO INOXIDABLE
ALUMINIUM. S/STEEL HANDLES
ALUMINIUM. MANCHE INOX
ALUMINIUM. STAHLSTIEL
ALUMINIO. CABO INOX

special



gas



vitro



3 mm

Antiadherente 2 capas
Non stick 2 coats
Antiadhérent 2 couches
Antihftbeschichtung 2 lagige
2 camadas de antiaderente

SARTEN

frypan
poêle
pfanne
sertã

mango acero inox
s/steel handle



ref.	cms.	H	📦	Bar Code
500418	18	4,3	6	8411922453133
500420	20	4,4	6	8411922453140
500422	22	4,4	6	8411922453157
500424	24	5,0	6	8411922453164
500426	26	5,2	6	8411922453171
500428	28	5,7	6	8411922453188
500430	30	5,8	6	8411922453195
500432	32	6,0	6	8411922453201
500436	36	6,2	4	8411922453218



SARTEN HONDA

Deep fry pan
Poêle profunde
Tiefe bratpfanne
Sertã funda



ref.	cms.	H	📦	Bar Code
500520	20	7	6	8411922455632
500524	24	8	6	8411922455649
500528	28	8	6	8411922455656
*500532	32	8,5	4	8411922457292

SARTEN HONDA CON ASAS

Deep fry pan with handles
Poêle profunde avec anses
Tiefe bratpfanne mit henkeln
Sertã funda com asas



ref.	cms.	H	📦	Bar Code
500624	24	8	6	8411922457308
500628	28	8	6	8411922457315
500632	32	8,5	4	8411922457322

Inducta

ALUMINIO PARA INDUCCION. MANGO BAQUELITA
ALUMINIUM FOR INDUCTION. BAKELITE HANDLE
ALUMINIUM POUR INDUCTION. MANCHE BAKELITE
ALUMÍNIO PARA INDUÇÃO. CABO BAQUELITE



induction



vitro



electric



gas



3 mm



Antiadherente 2 capas
Non stick 2 coats
Antiadhérent 2 couches
Antihaltbeschichtung 2 lagig
2 camadas de antiaderente



SARTEN
fry pan
poêle
frigideira



ref.	cms.	H.	📦	Bar Code
410016	16	4	6/12	8411922078381
410018	18	4,5	6/12	8411922078398
410020	20	4,5	6/12	8411922078404
410022	22	5,0	6/12	8411922078411
410024	24	5,0	6/12	8411922078428
410026	26	5,5	6/12	8411922078435
410028	28	6,0	6/12	8411922078442
410030	30	6,0	6/12	8411922078459

GRILL

grill
grill
bistechiera
grelhador



ref.	cms.	H.	📦	Bar Code
★410326	26	4,30	6/6	8411922080414

CREPIERA

crepe pan
poêle à crêpes
frigideira de crepes



ref.	cms.	H.	📦	Bar Code
411326	26	2,0	6/6	8411922083804
411328	28	2,0	6/6	8411922083811

LOTE 3 SARTENES INDUCTA 18+20+24

fry pan set
lot poêles
jogo frigideiras



ref.	cms.	📦	Bar Code
410700	18+20+24	4/4	8411922080964

FREIDORA CON CESTILLO

frying set with basket
friteuse avec panier
fritadeira com cesto



ref.	cms.	H.	📦	Bar Code
★410618	18	7,00	6/6	8411922082715
410624	24	7,60	6/6	8411922081435
410626	26	7,80	6/6	8411922080506

SARTEN HONDA CON MANGO

deep fry pan
poêle profonde
tiefe bratpfanne
frigideira funda

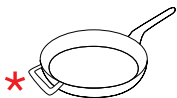

ref.	cms.	H.	📦	Bar Code
410420	20	7,20	6/6	8411922081695
410424	24	7,70	6/6	8411922080438
410426	26	7,80	6/6	8411922447941
410428	28	8,10	6/6	8411922080445
410430	30	8,30	6/6	8411922447958
* 410432	32	8,40	6/6	8411922080452

SARTEN HONDA CON ASAS

deep fry pan with handles
poêle profonde avec anses
tiefe bratpfanne mit henkeln
frigideira funda com asas



ref.	cms.	H.	📦	Bar Code
410524	24	7,70	6/6	8411922080469
410526	26	7,80	6/6	8411922447965
410528	28	8,10	6/6	8411922080476
410530	30	8,30	6/6	8411922447972
410532	32	8,40	6/6	8411922080483
410536	36	10,00	6/6	8411922080490
* 410540	40	11,50	4	8411922081725

* No inducción

SARTÉN PARA TAMAGOYAKI

Tamagoyaki pan
poêle pour Tamagoyaki
frigideira para Tamagoyaki



ref.	cms.	H.	📦	Bar Code
411218	15x18	3,5	6/12	8411922082951

El tamagoyaki (tamago=huevo y yaki=asar) es un tipo de tortilla enrollada típica de Japón. Existen infinidad de recetas para prepararla pudiendo ser dulce o salada, generalmente se prepara con Dashi (caldo japonés) o Mirin (vinagre japonés) pero también puede prepararse con salsa de soja, ingrediente más común en nuestra cocina. **RECETA EN LA TRASERA.**

ESP

Tamagoyaki (tamago=egg and yaki=roast) is a typical rolled Japanese omelette. There are many different recipes, sweet or savoury, and usually made with Dashi (Japanese broth) or Mirin (Japanese vinegar) but may also be made with soy sauce, the most common ingredient in our cuisine. **RECIPE IN BACK.**

ING



Con receta
With recipe
Avec recette
Con ricetta
Com receita

ESPÁTULA PARA TAMAGOYAKI

spatula Tamagoyaki
spatule Tamagoyaki
kelle Tamagoyaki
espátula Tamagoyaki

ibili design



~~BPA~~ max. 210°C

NYLON



ref.	cms.	📦	Bar Code
738770	25x12	6	8411922454383

Indubasic

ALUMINIO PARA INDUCCION. MANGO BAQUELITA
ALUMINIUM FOR INDUCTION. BAKELITE HANDLE
ALUMINIUM POUR INDUCTION. MANCHE BAKELITE
ALUMÍNIO PARA INDUÇÃO. CABO BAQUELITE



SARTEN

fry pan
poêle
frigideira



* caja expositora
display box
boîte presentoir
caixa expositora



ref.	cms.	H.	📦	Bar Code
* 405014	14	3,4	12/24	8411922077773
* (1) 405014C	14	3,4	12/24	8411922080421
405016	16	3,5	6/6	8411922077780
405018	18	3,7	6/6	8411922071481
405020	20	4,0	6/6	8411922071498
405022	22	4,2	6/6	8411922071511
405024	24	4,5	6/6	8411922071528
405026	26	4,7	6/6	8411922071535
405028	28	5,0	6/6	8411922071542
405030	30	5,2	6/6	8411922071559



(1)
4 verde/green/vert/verde
4 azul/blue/bleu/azul
4 naranja/orange/orange/naranja

SARTEN TORTILLAS

omelette pan
poêle a omelette
frigideira dupla

ibili design



* caja expositora
display box
boîte presentoir
caixa expositora



ref.	cms.	H.	📦	Bar Code
* 405914	14	6,5	6/12	8411922080797
405920	20	8	4/8	8411922080957
405924	24	9	4/8	8411922079241
405926	26	9,5	4/8	8411922435238
405928	28	10	4/4	8411922084764

GRILL CUADRADO

square grill
grill carré
grelhador quadrado



★ caja expositora
display box
boîte presentoir
caixa expositora



ref.	cms.	H.	📦	Bar Code
★ 405218	18x18	3	6/12	8411922076790
405226	26x26	4	6/6	8411922075151

WOK MINI

mini wok
wok mini
wok mini



★ caja expositora
display box
boîte presentoir
caixa expositora



ref.	Cms	H	📦	Bar Code
406116	16	5,8	6/12	8411922081176

SET SARTEN 18+22+26

fry pan set
lot poêles
jogo frigideiras



ref.	📦	Bar Code
405100	6/6	8411922075144

CREPIERA 4 CAVIDADES

crepe pan 4 cavities
poêle à crêpes 4 cavités
krepp-pfanne 4 hohlräume
sertã de crepes 4 cavidades



★ No inducción

ref.	cms.	∅	H	📦	Bar Code
406604	26	9	3,5	6	8411922448801

SARTÉN FREIDORA

frying set with basket
friteuse avec panier
fritadeira com cesto



ref.	cms.	H.		Bar Code
405726	26	6,8	6/6	8411922078688

SARTEN DE PESCADO

fish fry pan
poêle à poisson
frigideira de peixe



ref.	cms.	H.		Bar Code
406035	35x24	4,5	6/6	8411922080391

CREPIERA

crepe pan
poêle à crêpes
frigideira de crepes



ref.	cms.	H.		Bar Code
405820	20	1,7	6/6	8411922092653
405823	23	2	6/6	8411922083729
405826	26	2	6/6	8411922078695
405828	28	2	6/6	8411922080407

WOK

wok
wok
wok



ref.	Cms	H.		Bar Code
406130	30	8	6/6	8411922081466

Chef Style

LOTE SARTÉN 18+22+26 cm

18+22+26 cm fry pan set
lot 2 poêles 18+22+26 cm
Set 2 padelle 18+22+26 cm
Jogo 2 frigideiras 18+22+26 cm



ref.	cms.		Bar Code
407210	18+22+26	4/4	8411922435603

Venus

ALUMINIO. MANGO BAKELITA (RETRACTILADO)
ALUMINIUM. BAKELITE HANDLE (SHRINKED)
ALUMINIUM. MANCHE BAKELITE (SOUS FILM)
ALUMINIO. CABO BAQUELITE (RETRACTILADO)

special



vitro



electric



gas



1,5 mm



Antiaderente 2 capas
Non stick 2 coats
Antiadhérent 2 couches
Antihafbeschichtung 2 lagige
2 camadas de antiaderente

SARTÉN PARA TORTILLAS CON MANGOS DESMONTABLES

omelette pan removable handles
poêle à omelette manches amovibles
frigideira dupla cabos extraíveis



ref.	cms.	H.	📦	Bar Code
300620	20	10	4/4	8411922206869
300624	24	10	4/4	8411922206876

Artika

ALUMINIO. MANGO BAKELITA
ALUMINIUM. BAKELITE HANDLE
ALUMINIUM. MANCHE BAKELITE
ALLUMINIO. MANICO BACHELITE
ALUMINIO. CABO BAQUELITE

special



vitro



electric



gas



2 mm

Antiaderente 2 capas
Non stick 2 coats
Antiadhérent 2 couches
Antihafbeschichtung 2 lagige
2 camadas de antiaderente

SARTÉN

fry pan
poêle
padella
frigideira



ref.	Cms.	📦	Bar Code
321118	18	12/12	8411922086751
321120	20	12/12	8411922086768
321122	22	12/12	8411922086775
321124	24	12/12	8411922086782
321126	26	12/12	8411922086799
321128	28	12/12	8411922086805
321130	30	12/12	8411922086812

Blinis

ALUMINIO. MANGO ACERO
ALUMINIUM. METALLIC HANDLE
ALUMINIUM. MANCHE METALICO
ALUMINIO. CABO METALICO

special



vitro



electric



gas



4 mm

Antiaderente 2 capas
Non stick 2 coats
Antiadhérent 2 couches
Antihafbeschichtung 2 lagige
2 camadas de antiaderente

SARTEN BLINIS

blinis frypan
poêle à blinis
frigideira blinis



SARTEN BLINIS

frypan
poêle
padella
frigideira



ref.	cms.	H.	📦	Bar Code
404512	12	2,2	12/24	8411922085082

ref.	cms.	H.	📦	Bar Code
404514	14	2,80	12/24	84119220091618

Moka

ACERO C/ANTIADHERENTE
ROLLED STEEL/PLATE
ACIER ANTIADHÉRENT
CHAPA DE FERRO



gas



1 mm



Antiadherente 1 capa
Non stick 1 coat
Antiadhérent 1 couche
Antihaftbeschichtung 1 lagige
1 camada de antiaderente

WOK

wok
wok
wok



ref.	cms.	H.		Bar Code
450530	30	8	6/6	8411922083156

VAPORERA DE BAMBU

bamboo steamer
cuiseur vapeur bambou
vaporeira bambu



ref.	cms.	H.		Bar Code
727500	20	23	1/6	8411922084788

CESTILLO VAPOR CON TAPA

Steamer basket with lid
Panier vapeur avec couvercle
Dämpfkorb mit Deckel
Cesto de cocção ao vapor com tampa

max. 230°C
min. -60°C

LFGB

SILICONE



Posibilidad de apilar
varias unidades
Possibility of
stacking multiple units

ref.	Ø	H		Bar Code
682900	18	10	1/6/24	8411922456639

SARTÉN PARA CASTAÑAS

chestnut pan
poêle à marrons
padella castagne
frigideira de castanhas

special



vitro



electric



gas



libili design

ref.	cms.	H		Bar Code
450726	26	3,5	6/6	8411922089097

GRILL – CHURRASQUERA

gas - grill
grill - gaz
grill - gas
grill - gas

Con receta
With recipe
Avec recette
Con ricetta
Com receita



gas

Acero esmaltado + inox
Enamel steel + s/steel
Acier émaillé + inox
Emailliertem stahl + edelstahl
Aço esmaltado + inox



ref.	cms.	H.		Bar Code
980032	32	9	1	8411922447934

MiniAlu

ALUMINIO. MANGO BAKELITA
 ALUMINIUM. BAKELITE HANDLE
 ALUMINIUM. MANCHE BAKELITE
 ALUMINIUM. GRIFF AUS BAKELIT
 ALUMINIO. CABO BAKELITE

special

 Antiadherente 2 capas
 Non stick 2 coats
 Antiadhérent 2 couches
 Anhaftbeschichtung 2 lagige
 2 camadas de antiaderente

SARTÉN MINI
 Frying pan MINI
 Poêle MINI
 Pfanne MINI
 Sertã MINI

ibili design

AHORRO EN ENERGIA & ACEITE
 SAVE OIL & ENERGY

PPG Xylan® Plus
 Reliable long-life non-stick coating



BLUEBERRY

AVOCADO

ANANAS

ref.	cms.	H		Bar Code
404014A	14	3	6	8411922457735

ref.	cms.	H		Bar Code
404014B	14	3	6	8411922457742

ref.	cms.	H		Bar Code
404014C	14	3	6	8411922457759



FIGUE

PITAYA

ref.	cms.	H		Bar Code
404014D	14	3	6	8411922457766

ref.	cms.	H		Bar Code
404014F	14	3	6	8411922457780

CHERRY

ref.	cms.	H		Bar Code
404014E	14	3	6	8411922457773

*soft touch
tacto suave*



EXPOSITOR / DISPLAY

Display: 72pcs.

ref.	H		Bar Code
000970	1,60	1	8411922454895

Colorful

ACERO ESMALTADO VITRIFICADO. MANGO BAKELITA
 VITRIFIED ENAMELLED STEEL. BAKELITE HANDLE
 ACIER ÉMAILLÉ VITRIFIÉ. MANCHE BAKELITE
 STAHL EMAILLIERT. GRISS AUS BAKELIT
 AÇO ESMALTADO VITRIFICADO. CABO BAQUELITE

special



induction



vitro



electric



gas



Antiaderente 2 capas
 Non stick 2 coats
 Antiadhérent 2 couches
 Anhaftbeschichtung 2 lagige
 2 camadas de antiaderente

PF0A

SARTÉN MINI

Frying pan MINI

Poêle MINI

Pfanne MINI

Sertã MINI

libili design



PETROL

ref.	cms.	H	📦	Bar Code
930014A	14	4,5	6	8411922455038



GRISE

ref.	cms.	H	📦	Bar Code
930014D	14	4,5	6	8411922455069



CITRON

ref.	cms.	H	📦	Bar Code
930014B	14	4,5	6	8411922455045



MUSGO

ref.	cms.	H	📦	Bar Code
930014E	14	4,5	6	8411922455076



PECHE

ref.	cms.	H	📦	Bar Code
930014C	14	4,5	6	8411922455052



CIEL

ref.	cms.	H	📦	Bar Code
930014F	14	4,5	6	8411922455083



Display: 72pcs.

ECO

Ahorro en energía & aceite
 Save oil & energy



EXPOSITOR / DISPLAY

ref.	H	📦	Bar Code
000970	1,60	1	8411922454895

PERFECT HUEVO FRITO FRIED EGG



Korinto

ACERO ESMALTADO VITRIFICADO
VITRIFIED ENAMEL STEEL
ACIER ÉMAILLÉ VITRIFIÉ
AÇO ESMALTADO VITRIFICADO



Antiaderente 2 capas
Non stick 2 coats
Antiadhérent 2 couches
Antihaltbeschichtung 2 lagige
2 camadas de antiaderente

FREIDORA CON CESTILLO + TAPA DE VIDRIO, ASAS METÁLICAS

frying set with basket & glass lid, metallic handles
friteuse avec panier et couvercle en verre, anses métalliques
fritadeira com cesto e tampa vidro, asas metálicas



ref.	cms.	H.	lts.	📦	Bar Code
961224T	24	12,5	4,60	1/4	8411922096293

Volcán

ACERO ESMALTADO VITRIFICADO. ASAS METÁLICAS
VITRIFIED ENAMEL STEEL. METALLIC HANDLES
ACIER ÉMAILLÉ VITRIFIÉ. ANSES MÉTALLIQUES
AÇO ESMALTADO VITRIFICADO. ASAS METÁLICAS



FREIDORA CON CESTILLO+ TAPA VIDRIO

frying set with basket & glass lid
friteuse avec panier et couvercle en verre
fritadeira com cesto e tampa vidro



ref.	cms.	H.	lts.	📦	Bar Code
931624T	24	12,5	4,6	1/4	8411922042245

FREIDORA CON CESTILLO

frying set with basket
friteuse avec panier
fritadeira com cesto



ref.	cms.	H.	lts.	📦	Bar Code
931624	24	12,5	4,6	4/4	8411922031249

New Orange

ACERO ESMALTADO VITRIFICADO. MANGO BAKELITA
VITRIFIED ENAMELLED STEEL. BAKELITE HANDLE
ACIER ÉMAILLÉ VITRIFIÉ. MANCHE BAKELITE
ACCIAIO SMALTATO. MANICO IN BACHELITE
AÇO ESMALTADO VITRIFICADO. CABO BAQUELITE



SARTÉN

fry pan
poêle
padella
frigideira



PF0A

Antiaderente 2 capas
Non stick 2 coats
Antiadhérent 2 couches
Antihaltbeschichtung 2 lagige
2 camadas de antiaderente

ref.	cms.	H.	📦	Bar Code
916318	18	4,2	6/6	8411922207798
916320	20	4,3	6/6	8411922207804
916322	22	4,3	6/6	8411922207811
916324	24	4,6	6/6	8411922207828
916326	26	4,7	6/6	8411922207835
916328	28	4,9	6/6	8411922207842

SARTÉN HONDA CON ASAS

deep fry pan with handles
poêle profonde avec anses
frigideira funda com asas



ref.	cms.	H.	lts.	📦	Bar Code
916726	26	7,6	2,5	6/6	8411922161441
916728	28	8,3	3,0	6/6	8411922161458
916732	32	9,5	5,0	4/4	8411922161953
916736	36	11,0	8,0	4/4	8411922068757
916740	40	11,0	11,0	4/4	8411922068764

SARTÉN HONDA CON MANGO

deep fry pan with handle
poêle profonde avec manche
frigideira funda con cabo



ref.	cms.	H.	📦	Bar Code
916526	26	7,6	6/6	8411922209075
916528	28	8,3	6/6	8411922209082
* 916530	30	8,7	4/4	8411922161465
* 916532	32	9,5	4/4	8411922191960

Accesorios

CESTILLO PARA CAZO

Basket for sauce pan
Panier pour casserole
Siebeinsatz für Kochtöpfe
Cesto para caçarola

INOX /
S. STEEL

UNIVERSAL

loili design



ref.	Ø.	H	📦	Bar Code
751918	18	8	6	841192205732

SET 3 PROTECTORES DE SARTENES Y CACEROLAS

set 3 pan protectors
3 feuilles protection pour poêles et casseroles
jogo 3 protectores para frigideiras



ref.	cms.	📦	Bar Code
782650	35-40-45	6/48	8411922437683

CESTILLO FREIDOR DE REJILLA INOX (PARA SARTÉN)

stainless steel mesh frying basket (for frying pan)
panier à friture avec grille en inox (pour poêle)

frittierkorb aus edelstahl (für pfannen)
cesto para fritar de rede inox (para frigideira)



ref.	cms.	H	📦	Bar Code
730818	16,5	6	6	8411922448269
730824	22,5	7	6	8411922448276
730826	24,5	7	6	8411922448283
730828	26,5	7	6	8411922448290

CESTILLO FREIDOR ESTAÑADO 2 ASAS

frying basket with two side handles, tin plated
panier étamé avec anses
cesto de fritadeira com asas estanhado



ref.	cms.	📦	Bar Code
751823	23	4/4	8411922202113

TOSTADOR DE PAN ACERO ESTAÑADO

bread toaster, tin plate
grille pain, étamé
torrador de pão, estanhado



ref.	cms.	📦	Bar Code
810400	20x20	6/6	8411922600087

PLATO DE HIERRO FUNDIDO + BASE DE MADERA

Cast iron plate + wooden base

Plat en fonte de fer + base en bois

Gusseisenplatte + Holzuntersatz

Prato de ferro fundido + base de madeira



ref.	Ø	H	☐	Bar Code
627026	26-34	3,8	1/4	8411922456431
627030	30-40	4,2	1/4	8411922456684

PLATO DE HIERRO FUNDIDO

cast iron plate

plat en fonte de fer

gusseisenplatte

prato de ferro fundido

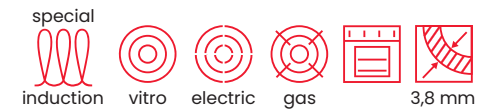

ref.	cms.	H.	☐	Bar Code
625926	26	2	1/4	8411922452099
625930	30	2	1/4	8411922452105

SOPORTE INOX PARA PLATO DE HIERRO

support for plate

support pour plat

halterung für platte

soporte para prato

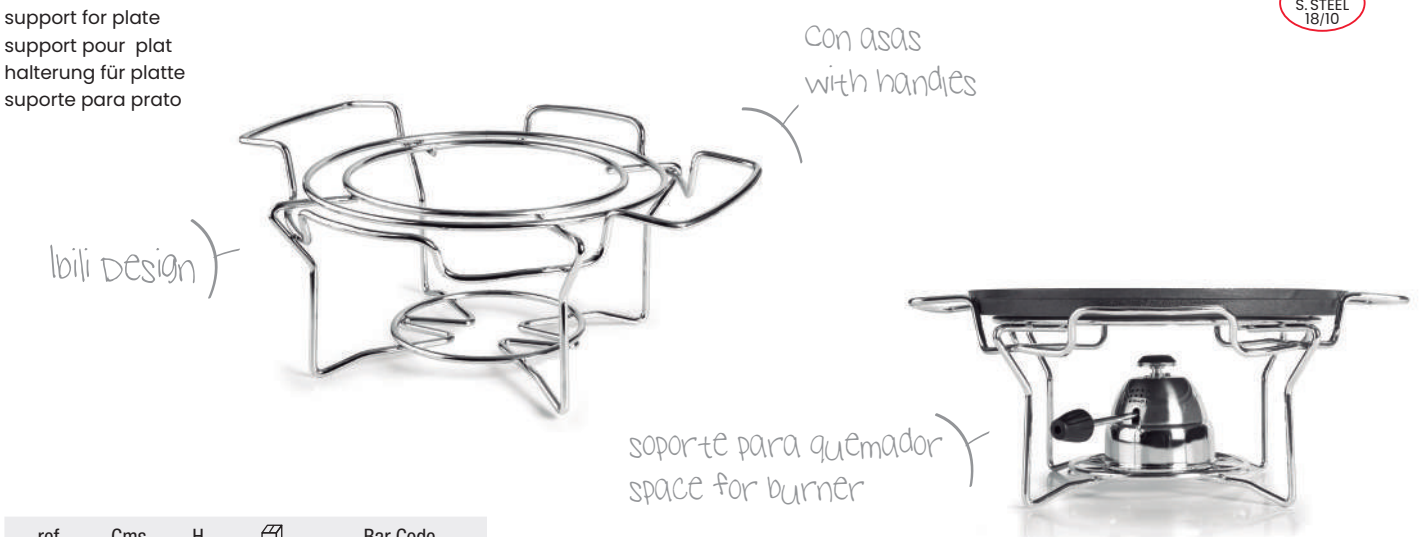

ref.	Cms.	H	☐	Bar Code
700900	33	14	1/6	8411922453119
700950	37,5	14	1/6	8411922456448

para plato de 26 cm / for 26 cm dish
para plato de 30 cm / for 30 cm dish





paelleras

"paella" pans

plats à paëlla
Paellapfannen
paelheiras

Triply Energy	56
Evolution	56
Premier	57
Bistrot	57
Inducta	58
Fusion	58
Nero	58
Gandia	59
Orange	59

Triply Energy

ACERO INOXIDABLE + ALUMINIO
S. STEEL + ALUMINIUM
INOX + ALUMINIUM
INOX + ALUMINIO

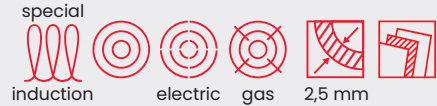

Antiaderente 3 capas
Non stick 3 coats
Antiadhérent 3 couches
Anhaftbeschichtung 3 lagige
3 camadas de antiaderente

PAELLERA
"paella" pan
plat à paëlla
paelheira



lbili design

3 CAPAS



► DISTRIBUCIÓN UNIFORME Y EFICIENTE DEL CALOR EN TODA LA SUPERFICIE
► UNIFORM AND EFFICIENT HEAT DISTRIBUTION OVER THE ENTIRE SURFACE

ref.	cms.	H.	personas	paquetes	Bar Code
652130	30	4,1	4	2/6	8411922457148
652134	34	4,4	6	2/6	8411922457155
652138	38	4,5	8	2/6	8411922457162
652142	42	5,0	10	2/6	8411922457179

Evolution

ALUMINIO FUNDIDO INDEFORMABLE
UNDEFORMABLE CAST ALUMINIUM
FONTE D'ALUMINIUM INDEFORMABLE
ALLUMINIO FUSO INDEFORMABILE
ALUMINIO FUNDIDO INDEFORMÁVEL



Antiaderente 3 capas
Non stick 3 coats
Antiadhérent 3 couches
Anhaftbeschichtung 3 lagige
3 camadas de antiaderente

PAELLERA
"paella" pan
plat à paëlla
paelheira

asas desmontables
detachable handles

lbili design



ref.	cms.	H.	personas	paquetes	Bar Code
461436	36	4,7	6	1/4	8411922437430

Premier

ACERO INOXIDABLE. ASAS INOX 18/10
S. STEEL. S. STEEL 18/10 HANDLES
INOX. ANSES INOX 18/10
INOX. ASAS INOX 18/10



Fondo acero 18%
Steel bottom
Fond inox
Stahlboden
Fundo inox

PAELLERA
"paella" pan
plat à paëlla
paelheira

ibili design



ref.	cms.	H.	person	box	Bar Code
652228	28	4,0	2	4/16	8411922075274
652232	32	4,0	5	4/16	8411922075281
652234	34	4,5	6	2/8	8411922075298
652236	36	4,5	7	2/8	8411922075304
652240	40	5,0	9	2/8	8411922075311

Bistrot

ACERO INOXIDABLE. ASAS INOX 18/10
S. STEEL. S. STEEL 18/10 HANDLES
INOX. ANSES INOX 18/10
INOX. ASAS INOX 18/10



Fondo acero 18%
Steel bottom
Fond inox
Stahlboden
Fundo inox

PAELLERA
"paella" pan
plat à paëlla
paelheira



ibili design



Antiadherente 3 capas
Non stick 3 coats
Antiadhérent 3 couches
Antihafbeschichtung 3 lagige
3 camadas de antiaderente



ref.	cms.	H.	person	box	Bar Code
652028	28	4,0	2	4/16	8411922069518
652032	32	4,0	5	4/16	8411922422146
652034	34	4,5	6	2/8	8411922422153
652036	36	4,5	7	2/8	8411922422160
652040	40	5,0	9	2/8	8411922068849
652045	45	5,5	12	2/8	8411922078336

SET 2 ASAS PROTECTORAS PARA PAELLERA

Set 2 Paella pan handle covers

Set 2 Anses de protection pour les plats à paella

Set 2 Griffschutz für paella-panne

Set 2 Asas protetoras para paelheira.

max.
230°C



ibili design



Adaptable a la mayoría de modelos y medidas de asas para paellera.
Can be adapted to the majority of sizes and models of paella pan handles



ref.	Cms	box	Bar Code
627100	9,5	6/120	8411922456691

Inducta

ALUMINIO PARA INDUCCION. ASAS METALICAS
ALUMINIUM FOR INDUCTION. METALLIC HANDLES
ALUMINIUM POUR INDUCTION. ANSES METALLIQUES
ALUMÍNIO PARA INDUÇÃO. ASAS METÁLICAS



PAELLERA
"paella" pan
plat à paëlla
paelheira



asas negras
black handles

ref.	cms.	H.	■	📦	Bar Code
410226	26	4,10	2	4/24	8411922078466
410230	30	4,10	4	4/24	8411922078473
410234	34	4,40	6	4/12	8411922078480
410238	38	4,50	8	2/8	8411922078497
410242	42	5,00	10	2/8	8411922078893

Fusion

ALUMINIO PARA INDUCCION. ASAS METALICAS
ALUMINIUM FOR INDUCTION. METALLIC HANDLES
ALUMINIUM POUR INDUCTION. ANSES METALLIQUES
ALUMÍNIO PARA INDUÇÃO. ASAS METÁLICAS



PAELLERA
"paella" pan
plat à paëlla
paelheira



mango inox
steeel handle



ref.	cms.	H.	■	📦	Bar Code
451126	26	4,2	2	4	8411922450026
451130	30	4,2	4	4	8411922450033
451134	34	4,2	6	4	8411922450040
451138	38	4,2	8	4	8411922450057
451142	42	4,2	10	4	8411922450064

Nero

ALUMINIO. ASAS METÁLICAS
ALUMINIUM. METALLIC HANDLE
ALUMINIUM. ANSES METALLIQUES
ALUMÍNIO. ASAS METÁLICAS



PAELLERA
"paella" pan
plat à paëlla
paelheira



ref.	cms.	H.	■	📦	Bar Code
380030	30	4,2	4	4/24	8411922070705
380034	34	4,4	6	4/24	8411922070712
380038	38	4,5	8	4/16	8411922070729
380042	42	5,1	10	4/16	8411922070736
380046	46	5,2	12	4/8	8411922070743
380050	50	5,2	14	4/8	8411922070750

Gandia

ACERO ANTIADHERENTE
NON-STICK STEEL
ACIER ANTIADHÉRENT
ACCIAIO ANTIADERENTE
FERRO ANTIADERENTE



vitro



electric



gas



Antiaderente 1 capa
Non stick 1 coat
Antiadhérent 1 couche
Antihftbeschichtung 1 lagige
1 camada de antiaderente

PAELLERA

"paella" pan
plat à paëlla
paellera
paelheira

~~PEOA~~

metallic



ref.	cms.	H	👤	📦	Bar Code
501028	28	4,0	2	4/12	8411922434347
501032	32	4,5	5	4/12	8411922434354
501036	36	4,5	7	4/12	8411922434361
501040	40	5,0	9	4/8	8411922434378
501046	46	5,0	12	4/8	8411922434385

Orange

ACERO ESMALTADO VITRIFICADO
VITRIFIED ENAMEL STEEL
ACIER ÉMAILLÉ VITRIFIÉ
AÇO ESMALTADO VITRIFICADO



induction



special

vitro



special

electric



gas



1 mm



1 mm

Antiaderente 2 capas
Non stick 2 coats
Antiadhérent 2 couches
Antihftbeschichtung 2 lagige
2 camadas de antiaderente

PAELLERA CON ASAS METÁLICAS

"paella" pan. metallic handles
plat à paëlla. anses métalliques
paelheira. asas metálicas

~~PEOA~~



ref.	cms.	H.	👤	📦	Bar Code
917130	30	5,3	4	6/6	8411922068665
917134	34	5,4	6	6/6	8411922068672
917138	38	6,0	8	6/6	8411922068689
917142	42	6,0	10	4/4	8411922068696

EXPOSITOR PAELLERAS

paella dish stand
présentoir plat à paëlla
espositore paellera
expositor para paelheiras

Para moldelos / for models:

Bistrot - Premier - Triply
Inducta - Nero - Gandia



Regulable
Adjustable
Réglable
Regolabile
Regulável

175CM



ibili design

65CM

ref.	H	📦	Bar Code
000906	175	1	8411922435023





horno

roast pans

four
Backofen
forno

iChef	62
Induplus	62
Bistrot	62
Clásica	62
Moka	63
Plus	63
Blu	63
Venus	64
Moka	65
Acero estañado-promo	65
Varios	66
Accesorios	67

iChef

ACERO INOXIDABLE 18%
S.STEEL 18%



RUSTIDERA PROFESIONAL

roast pan
plat à four
bratp fanne
tabuleiro



ref.	cms.	H.		Bar Code
652735	39,5x28	5,70	6	8411922451771
652738	42,5x31	6,20	6	8411922451788

Induplus

ALUMINIO FUNDIDO, PARA HORNO E INDUCCIÓN
CAST ALUMINIUM FOR OVEN AND INDUCTION
ALUMINIUM EN FONTE POUR FOUR ET INDUCTION
ALUMINIO FUNDIDO PARA FORNO E INDUÇÃO



DUO FUENTE DE HORNO/PLANCHA

duo roaster/grill
duo plat à four/grill
duo tabuleiro/grelhador



bili design



Doble uso, como rustidera para horno y plancha, para todo tipo de fuegos.
Double use as roaster for oven and grill, for all kind of stoves.
Double usage comme plat à four et grill pour tous feux.
Duplo uso como tabuleiro para forno e grelhador para todo tipo de fogo.

ref.	cms.	H.		Bar Code
401534	40x26	6,5	4/4	8411922083781

Bistrot



RUSTIDERA CON ASAS INOX ABATIBLES

roast pan with folding s. steel handles
plat à rôtir avec anses pliantes inox
tabuleiro com asas amovíveis inox

ref.	cms.	H.	lts.		Bar Code
651830	31x24	5,5	3,2	4/12	8411922209600
651835	38x27	6,5	5,1	6/6	8411922209617
651840	43x31	7,0	7,4	6/6	8411922209624
651845	48x34	7,0	9,3	4/4	8411922209631
651850	53x38	7,5	12,4	4/4	8411922209648
651860	63x45	7,5	18,4	4/4	8411922209662



Clásica



RUSTIDERA CON ASAS METÁLICAS ABATIBLES

roast pan with folding metallic handles
plat à rôtir avec anses pliantes métalliques
tabuleiro com asas amovíveis metálicas



ref.	cms.	lts.		Bar Code
651425	25x19x5,5	2,3	4/12	8411922204070
651430	30x22x6	3,5	4/12	8411922204087
651435	35x26x6,5	5,4	4/12	8411922204094
651440	40x28x7	7,5	4/8	8411922204377



Moka



0,8 mm

Antiaderente 2 capas
Non stick 2 coats
Antiadhérent 2 couches
Antihafbeschichtung 2 lagige
2 camadas de antiaderente

RUSTIDERA EXTRAFUERTE CON ASAS

roast pan with folding handles
plat à rôtir vec anses
rostidera con manici
tabuleiro com asas



EXTRAFUERTE
EXTRAHEAVY

ref.	cms.	H.		Bar Code
828340	40x28	6,8	6/6	8411922093865

Plus



RUSTIDERA CON ASAS METÁLICAS ABATIBLES. ANTIADHERENTE

roast pan with folding metallic handles. Non stick.
plat à rôtir avec anses pliantes métalliques. Antiadherent.
tabuleiro com asas amovíveis metálicas. Antiaderente



ref.	cms.	lts.		Bar Code
651330	30x22x6	3,5	4/12	8411922204049

Blu

ALUMINIO
ALUMINIUM
ALUMINIUM
ALUMINIO



Antiaderente 2 capas
Non stick 2 coats
Antiadhérent 2 couches
Antihafbeschichtung 2 lagige
2 camadas de antiaderente

RUSTIDERA

roast pan
plat à rôtir
tabuleiro



ref.	cms.	lts.		Bar Code
330029	29x20x5	2,2	6/6	8411922160079
330040	40x27x6	5,5	6/6	8411922160093

FUENTE DE HORNO

roast pan
plat à rôtir
tabuleiro



ref.	cms.	lts.		Bar Code
330140	40x33x7	7,5	6/6	8411922160130

MOLDE PIZZA CRISPY

pizza mould crispy
moule à pizza crispy
forma de pizza crispy



ref.	cms.	H.		Bar Code
331228	28	1,8	6/6	8411922160444
331232	32	2,0	6/6	8411922160451

Venus

ALUMINIO
ALUMINIUM
ALUMINIUM
ALUMINIO



Antiaderente 2 capas
Non stick 2 coats
Antiadhérent 2 couches
Antihaftbeschichtung 2 lagige
2 camadas de antiaderente



RUSTIDERA

roast pan
plat à rôtir
tabuleiro



ref.	cms.	lts.		Bar Code
300929	29x20x5	2,2	6/6	8411922218299
300935	35x24x6	3,5	6/6	8411922218367
300940	40x27x6	5,5	6/6	8411922218404

FUENTE DE HORNO

roast pan
plat à rôtir
tabuleiro



ref.	cms.	lts.		Bar Code
301140	40x33x7	7,5	6/6	8411922262407

MOLDE PIZZA

pizza mould
moule à pizza
forma de pizza



ref.	cms.	H.		Bar Code
356928	28	1,8	6/6	8411922207897
356932	32	2,0	6/6	8411922207903

MOLDE PIZZA CRISPY

pizza mould crispy
moule à pizza crispy
forma de pizza crispy



ref.	cms.	H.		Bar Code
356124	24	1,8	6/6	8411922226249
356128	28	1,8	6/6	8411922226287
356132	32	2,0	6/6	8411922226324

Moka

CHAPA DE ACERO
ROLLED STEEL PLATE
ACIER ANTIADHÉRENT
CHAPA DE FERRO



Antiadherente 2 capas
Non stick 2 coats
Antiadhérent 2 couches
Antihafbeschichtung 2 lagige
2 camadas de antiaderente



RUSTIDERA

roast pan
plat à rôtir
tabuleiro



ref.	cms.	📦	Bar Code
822028	31,3x20x3,5	6/72	8411922071290
822033	40,5x25,5x4,7	6/36	8411922423792
822037	40,5x26,5x5	6/36	8411922423808
822040	44,5x29x5	6/36	8411922207316

RUSTIDERA DIET CON PARRILLA

roast pan diet with grill
plat à four diet avec grill
rostidera diet con griglia
tabuleiro diet com grelha



ref.	cms.	H	📦	Bar Code
828637	37,5x27	4,5	6/12	8411922433661

FUENTE DE HORNO

roast pan
plat à rôtir
tabuleiro



ref.	cms.	lts.	📦	Bar Code
822236	36x25x6	4,8	10/10	8411922206852
822239	40x25x6	5,0	10/10	8411922202465

MOLDE PIZZA CRISPY

pizza mould crispy
moule à pizza crispy
forma de pizza crispy



ref.	cms.	H.	📦	Bar Code
821928	28	1,8	6/48	8411922904123
821932	32	1,8	6/48	8411922904130

Acero estañado-promo

ACERO ESTAÑADO
TIN PLATED
FER ÉTAMÉ
FERRO ESTANHADO



FUENTE HORNO PROMO

roast pan Promo
plat à four Promo
tabuleiro Promo



ref.	cms.	lts.	📦	Bar Code
810628	30x25x6	4,0	6/6	8411922708035
810635	36x25x6	4,8	6/6	8411922708127
810639	40x25x6	5,0	6/6	8411922708080

MOLDE PIZZA CRISPY

pizza mould crispy
moule à pizza crispy
forma de pizza crispy



ref.	cms.	H.	📦	Bar Code
802428	28	1,8	6/48	8411922721287

Varios

PIEDRA PARA PIZZA CON SOPORTE

pizza stone with base
pierre pour pizza avec support
pedra para pizza com suporte

max.
500°C

Total con base: 35 cms.



ref.	cms.	📦	Bar Code
778333	33	1/4	8411922080902

PIEDRA PARA PIZZA RECTANGULAR

rectangular pizza stone
pierre pour pizza rectangulaire
pedra para pizza rectangular

max.
500°C

Total con base: 46,5 cms.



ref.	cms.	📦	Bar Code
784338	38x30x1,1	1/6	8411922435702
784340	41x36x1,5	1/4	8411922084801

PALA-BASE PARA PIZZAS

Server-base for pizza
Pelle à gâteaux et pizzas
Pizzahheber
Pá-baseie pára pizzas

MADERA DE HAYA BEECH WOOD

Las piezas no son totalmente planas, pueden presentar curvaturas debido a que están fabricadas en madera natural.
The items are not completely flat. They may have slight curve because they are made of natural wood.

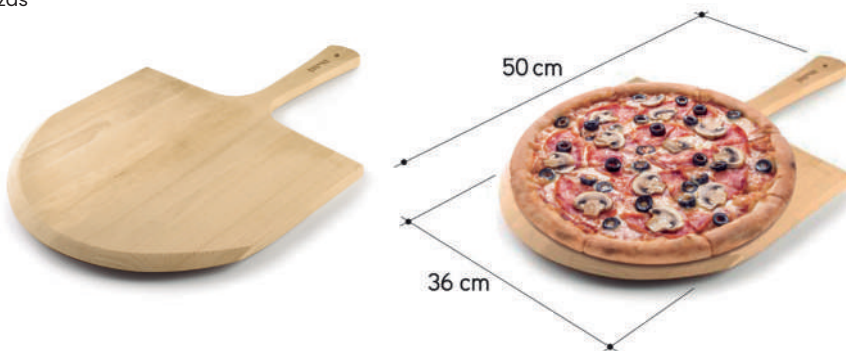

ref.	Cms.	H	📦	Bar Code
682700	50x35	1,5	6	8411922455977

REJILLA PARA PIZZA

roast pan
plat à four
bratp fanne
tabuleiro

INOX / S. STEEL

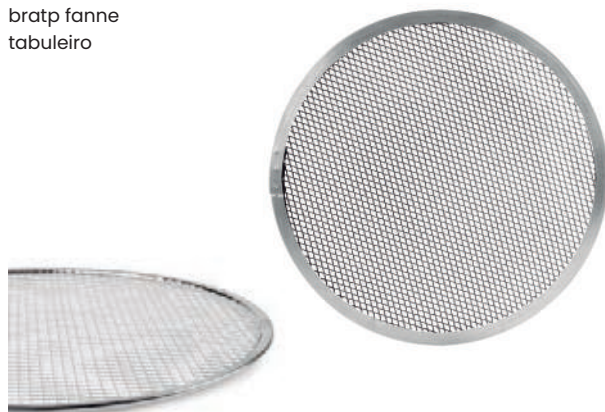

ref.	cms.	📦	Bar Code
713830	30	6/96	8411922453928

REJILLA PARA PIZZA

pizza screen
grille pour pizza
pizzablech mit gitterstruktur
grelha para pizza

ALUMINIUM



ref.	cms.	📦	Bar Code
715630	30	6	8411922451429

Accesorios

PAPEL ANTIADHERENTE PARA HORNO EN LAMINAS

non stick oven proof paper sheets
papier cuisson antiadesif en fevilles
papel antiaderente para forno en folhas

max.
220°C



Cocinar + Conservar
For cooking and coserving



42 cm
38 cm
Hojas pre-cortadas
Pre-cut sheets
Feuilles prédécoupées
Folhas cortadas

20 ud.

ref.	Cms		Bar Code
200742	42x38	1/24	8411922438710

PAPEL PARA HORNO

oven proof paper
papier cuisson
papel para forno

max.
220°C



ref.	cms.		Bar Code
200730	10mx29cm	1/24	8411922069228

LAMINA ANTIADHERENTE

non-stick cooking mat
feuille de cuisson anti-adhérente
folha de cozinha antiaderente



SPRAY DESMOLDEANTE ANTIADHERENTE

mould greasing spray
spray démoulant
spray antiaderente
spray para desenformar



-Permite un fácil desmoldeo de pasteles, bizcochos, madalenas, galletas etc
-Enables cakes, biscuits, muffins, cookies, etc to be easily removed from the mould.

Utilizable cientos de veces por ambas caras.
Can be used on both sides hundreds of times.
S'utilise plusieurs centaines de fois sur les 2 faces.
Utilizavel várias vezes nas duas faces.

ref.	cms.		Bar Code
200840	40x33	6/12	8411922073126

ref.	Lts.		Bar Code
746300	0,250	1/6	8411922436846



repostería

bakeware

pâtisserie

Konditoreiwaren	Golden Class	70
pastelaria	Cupra	72
	Blu	73
	Venus	74
	Strawberry	76
	Blueberry	78
	Varios	81
	Crous!	84
	Moka	85
	Mini Moka	94
	Clásica	96
	Fiberglas	101
	Aluminio	102
	Acero estañado	103
	Ceramic	105
	Banneton	106
	Kristall	107
	Ceramic	109
	Chocolate	109
	Flexible Chocolate	114
	Accesorios	118
	Turrón	119
	Hielo	122
	Sopletes	125
	Sifones-Alu	127
	Accesorios	129
	Profesional	138
	Boquillas	151
	Flex	159
	Professional	163
	Ecoprof	165
	Baking cups	178
	Blondas	183
	Fondant	188
	Anodized aluminium	190

Golden Class

ACERO ANTIADHERENTE
NON-STICK ROLLED STEEL
ACIER ANTIADHÉRENT
ACCIAIO ANTIADERENTE
FERRO ANTIADERENTE



Antiaderente 2 capas
Non stick 2 coats
Antiadhérent 2 couches
Antihafbeschichtung 2 lagige
2 camadas de antiaderente

ibili design

Extra-fuertes y resistentes
Extra-strong and resistant

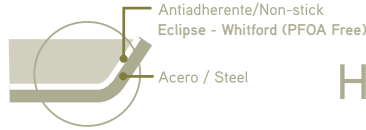

-Con colgador
-With hunger



Home & Professional

MOLDE DESMONTABLE BASE EXTRA

springform with extra base
moule démontable avec base supplémentaire
stampo removibile con base extra
forma desmontável com base extra



ref.	cm	H	📦	Bar Code
840026	26	7	6/6	8411922435719

MOLDE RIZADO

tart mould
moule à tart dentelé
stampo crostata
forma tarta canelada



ref.	cm	H	📦	Bar Code
840728	28	3	6/12	8411922435771

MOLDE CAKE

cake springform
moule à cake
stampo plumcake
forma de bolo inglês



ref.	cm	H	📦	Bar Code
840230	30x11	6,7	6/12	8411922435733

MOLDE ALTO

pie mould
moule haut
stampo torta alto
forma de bolo alto



ref.	cm	H	📦	Bar Code
840126	26	5,5	6/12	8411922435726

MOLDE PIZZA

pizza mould
moule à pizza
stampo per pizza
forma de pizza



ref.	cm	H	📦	Bar Code
840634	34	2,5	6/12	8411922435764

MOLDE CUADRADO

square springform
moule carré
stampo quadrato
forma quadrada



ref.	cm	H	📦	Bar Code
840324	24x24	5	6/12	8411922435740



uso doméstico & profesional
home & professional use



MOLDE MUFFIN 12 CAV.

muffin pan 12 cups
plaque à 12 biscuits
stampo per 12 muffin
tabuleiro 12 bolinhos



ref.	cm	H	Ø	📦	Bar Code
840500	38x29	3	6,5	6/12	8411922435757

MOLDE SAVARIN

savarin mould
moule à savarin
stampo savarin
forma savarin

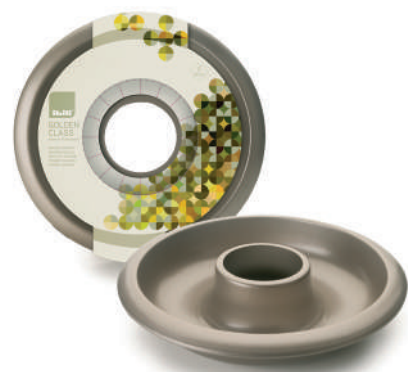

ref.	cm	H	📦	Bar Code
840826	26	6	6/12	8411922435788

BANDEJA PARA GALLETAS

cookie sheet
plaque à biscuits
teggia rettangolare
placa para massas



ref.	cm	H	📦	Bar Code
841041	41x32	1,6	6/12	8411922435801

RUSTIDERA

roast pan
plat à rôtir
rostidera
tabuleiro



ref.	cm	H	📦	Bar Code
840935	35x25	6,4	6/12	8411922435795



Con colgador
With hanger
Avec crochet
Com asa fixadora



Antiaderente 2 capas
Non stick 2 coats
Antiadhérent 2 couches
Anhaftbeschichtung 2 lagige
2 camadas de antiaderente



FLANERO RIZADO

brioche mould
moule à brioche
forma de pudim flan canelada

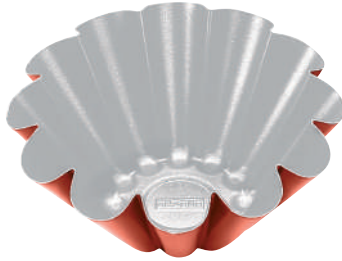

ref.	cms.	H.	lts.		Bar Code
370210	10	4,2	0,15	12/12	8411922070286

FLANERO INDIVIDUAL

cream caramel mould
moule à crème caramel
forma de pudim flan



ref.	cms.	H.	lts.		Bar Code
370308	8	5,5	0,18	12/12	8411922070323

MOLDE DESMONTABLE, ACERO

springform, rolled steel plated
moule démontable, acier
forma desmontável,
chapa de ferro



ref.	cms.	H.		Bar Code
371426	26	6,5	6/6	8411922070606

MOLDE SAVARIN

savarin mould
moule à savarin
forma savarin



ref.	cms.	H.	lts.		Bar Code
370826	26	5,9	2,0	6/6	8411922070453

MOLDE DESMONTABLE 2 USOS, ACERO

springform with tube, rolled steel plated
moule démontable 2 usages, acier
forma desmontável 2 usos, chapa de ferro



ref.	cms.	H.		Bar Code
371526	26	6,5	5/5	8411922070620

MOLDE CAKE

cake mould
moule à cake
forma de bolo inglês



ref.	cms.	lts.		Bar Code
370925	25x11x7	1,5	6/6	8411922070460

Blu

ALUMINIO
ALUMINIUM
ALUMINIUM
ALUMINIO



Con colgador
With hanger
Avec crochet
Com asa fixadora



Antiaderente 2 capas
Non stick 2 coats
Antiadhérent 2 couches
Antihärtbeschichtung 2 lagige
2 camadas de antiaderente



FLANERO CON TAPA INOX 18/10 Y CIERRES

pudding mould with lid
moule à pudding avec couvercle
forma de pudim flan com tampa e fechos



ref.	cms.	H.	lts.	📦	Bar Code
331118	18	10,3	2,00	6/6	8411922160420

FLANERO INDIVIDUAL

cream caramel mould
moule à crème caramel
forma de pudim flan



ref.	cms.	H.	lts.	📦	Bar Code
330408	8	5,5	0,18	12/12	8411922160222

MOLDE CAKE

cake mould
moule à cake
forma de bolo inglês



ref.	cms.	lts.	📦	Bar Code
331025	25x11x7	1,5	6/6	8411922160383
331030	30x11x7	2,2	6/6	8411922160390

MOLDE RIZADO MÓVIL

fruit tart mould, loose bottom
moule à tarte dentelé amovible
forma de tarte canelada,
fundo solto



ref.	cms.	H.	lts.	📦	Bar Code
331328	28	3,0	2,0	6/6	8411922160482

MOLDE SAVARIN

savarin mould
moule à savarin
forma savarin



ref.	cms.	H.	lts.	📦	Bar Code
330926	26	5,9	2,0	6/6	8411922160369

MOLDE DESMONTABLE, ACERO

spring form, rolled steel plate
moule démontable, acier
forma desmontável, chapa de ferro



ref.	cms.	H.	📦	Bar Code
331524	24	6,5	6/6	8411922160529
331526	26	6,5	6/6	8411922160536
331528	28	6,5	6/6	8411922160543

Venus

ALUMINIO
ALUMINIUM
ALUMINIUM
ALUMINIO



Con colgador
With hanger
Avec crochet
Com asa fixadora



Antiadherente 2 capas
Non stick 2 coats
Antiadhérent 2 couches
Antihafbeschichtung 2 lagige
2 camadas de antiaderente



MOLDE ALTO

pie mould
moule haut
forma de bolo alta



ref.	cms.	H.	lts.	📦	Bar Code
355422	22	4,8	1,2	6/6	8411922211221
355426	26	5,5	2,5	6/6	8411922211269
355430	30	5,5	3,0	6/6	8411922211306
355432	32	5,5	3,7	6/6	8411922077681

MOLDE SAVARIN

savarin mould
moule à savarin
forma savarin



ref.	cms.	H.	lts.	📦	Bar Code
355824	24	5,5	1,7	6/6	8411922215243
355826	26	5,9	2,0	6/6	8411922215267
355828	28	6	2,5	6/6	8411922077933

MOLDE BAJO

tart mould
moule bas
forma de bolo baixa



ref.	cms.	H.	lts.	📦	Bar Code
355527	27	3,9	2,0	6/6	8411922212273

MOLDE CAKE

cake mould
moule à cake
forma de bolo inglês



ref.	cms.	lts.	📦	Bar Code
355925	25x11x7	1,5	6/6	8411922216257
355930	30x11x7	2,2	6/6	8411922216301
355935	35x11x7	3,0	6/6	8411922077926

FLANERO RIZADO

brioche mould
moule à brioche
forma de pudim flan canelada



ref.	cms.	H.	lts.	📦	Bar Code
355210	10	4,2	0,15	12/12	8411922209105
355218	18	6,0	0,70	12/12	8411922209181
355222	22	6,0	1,50	6/6	8411922209228

MOLDE RIZADO

tart mould
moule à tarte dentelé
forma de tarte canelada



ref.	cms.	H.	lts.	📦	Bar Code
355728	28	3,0	2,0	6/6	8411922214284
355732	32	3,2	2,5	6/6	8411922214321

MOLDE DESMONTABLE 2 USOS, ACERO (retractilado)

springform with tube, rolled steel plate (shrunked)
moule démontable 2 usages, acier (sous film)
forma desmontável 2 usos, chapa de ferro (retractilado)



ref.	cms.	H.		Bar Code
356626	26	6,5	5/5	8411922802030

MOLDE DESMONTABLE, ACERO

springform, rolled steel plate
moule démontable, acier
forma desmontável, chapa de ferro



ref.	cms.	H.		Bar Code
356524	24	6,5	6/6	8411922802009
356526	26	6,5	6/6	8411922802016
356528	28	6,5	6/6	8411922802023

FLANERO INDIVIDUAL

cream caramel mould
moule à crème caramel
forma de pudim flan



ref.	cms.	H.	lts.		Bar Code
355308	8	5,5	0,18	12/12	8411922210088

MOLDE RIZADO MÓVIL

fruit tart mould, loose bottom
moule à tarte dentelé amovible
forma de tarte canelada, fundo solto



ref.	cms.	H.	lts.		Bar Code
356224	24	3	1,5	6/6	8411922236248
356228	28	3	2,0	6/6	8411922236286
356232	32	3,2	2,5	6/6	8411922236323

FLANERO CON TAPA INOX 18/10 Y CIERRE

pudding mould with lid
moule à pudding avec couvercle
forma de pudim flan com tampa e fechos



ref.	cms.	H.	lts.		Bar Code
356016	16	9,4	1,20	6/6	8411922219166
356018	18	10,3	2,00	6/6	8411922219180
356020	20	11,4	2,80	6/6	8411922068603

Strawberry

max. 230°C
min. -60°C



MOLDE CAKE FLEXIBLE

flexible plumcake mould
moule à cake souple
kuchenform
forma de bolo inglês flexível



loili design

ref.	Cms	📦	Bar Code
875125	25x10,5x6,5	6/24	8411922443080
875130	30x10,5x6,5	6/24	8411922443097

MOLDE RIZADO FLEXIBLE

flexible tart mould
moule à tarte dentelé souple
gewellte form
forma de tarta canelada



ref.	Cms	📦	Bar Code
875228	28x3	6/24	8411922444001

MOLDE ALTO FLEXIBLE

flexible pie mould
moule à manqué souple
tiefe form
forma d ebolo alta flexível



ref.	Cms	📦	Bar Code
875520	20x5,5	6/24	8411922444032
875526	26x5,5	6/24	8411922444049

MOLDE SAVARIN FLEXIBLE

flexible savarin mould
moule à savarin souple
guggelhupform
forma savarin flexível



ref.	Cms	📦	Bar Code
875424	24x5,5	6/24	8411922444025

FLANERO RIZADO FLEXIBLE

flexible brioche mould
moule à brioche souple
gewellte puddingform
forma de pudim flan canelada flexível



ref.	Cms	📦	Bar Code
875322	22x8	6/24	8411922444018

SET 2 FLANERO INDIVIDUAL

set of 2 cream caramel moulds
set 2 moule à crème caramel
set aus 2 puddingform
conjunto de 2 forma de pudim flan



ref.	Cms	Lts.	📦	Bar Code
875001	8	0,18	6/12/72	8411922443073

MOLDE MULTICAVIDADES FLEXIBLE

flexible multicup mould
moule souple multicauidité
form für muffins
forma multicauidades flexível



ref.	Cms	📦	Bar Code
875600	7,9x3,7	6/24	8411922444056

MOLDE DESMONTABLE REDONDO CON BASE DE CRISTAL

Round removable mould with glass base
 Moule amovible rond avec base en verre
 Auseinandernehmbare form mit glasboden, rund
 Forma desmontável redonda com base de vidro



ref.	Cms.	H		Bar Code
875712	12	4,5	1/6	8411922459029
875719	20	7,0	1/6/24	8411922458435
875700	26	7,5	2/6	8411922455243

MOLDE DESMONTABLE CUADRADO CON BASE DE CRISTAL

Square removable mould with glass base
 Moule amovible carré avec base en verre
 Auseinandernehmbare form mit glasboden, quadratisch
 Forma desmontável quadrada com base de vidro



ref.	Cms.	H		Bar Code
875800	25x25	7,5	2/6	8411922455250

MOLDE DESMONTABLE RECTANGULAR CON BASE DE CRISTAL

Rectangular removable mould with glass base
 Moule amovible rectangulaire avec base en verre
 Auseinandernehmbare form mit glasboden, rechteckig
 Forma desmontável retangular com base de vidro



ref.	Cms.	H		Bar Code
875900	28x13	7,5	2/6	8411922455267

MOLDE DOUGNUT 7 CAVIDADES STRAWBERRY

Doughnut mould with 7 cavities
Moule 7 cavités pour donuts
Donut-backform mit 7 mulden
Molde 7 cavidades para doughnut

ALTURA DE CONO PARA FÁCIL HORNEADO
CENTRAL CONE HEIGHT FOR EASY BAKING

ESPECIAL MICROONDAS
SPECIAL MICROWAVE

Con receta
With recipe

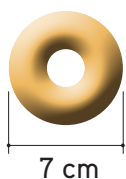

ref.	Ø	Cms.	H		Bar Code
876050	7	26	4,5	1/6/24	8411922458657

MOLDE DOUGNUT 6 CAVIDADES STRAWBERRY

Doughnut mould with 6 cavities
Moule 6 cavités pour donuts
Donut-backform mit 6 mulden
Molde 6 cavidades para doughnut

Altura de cono para fácil horneado
Central cone height for easy baking

Con receta
With recipe
Avec recette
Con ricetta
Com receita



lili design



ref.	Ø	Cms	H		Bar Code
876000	8	22x32	5	1/6/36	8411922455984

Blueberry



max. 230°C
min. -60°C



lili design

FLANERO RIZADO

brioche mould
moule à brioche
forma de puding flan canelada



ref.	cms.	lts.		Bar Code
870008	22x8	1,6	6/24	8411922082609

MOLDE CAKE

plumcake
moule à cake
forma de bolo inglês



ref.	cms.	lts.		Bar Code
870004	25x10,5x6,5	1,4	6/24	8411922082562
870005	30x10,5x6,5	2,2	6/24	8411922082579

~~BPA~~

FLANERO INDIVIDUAL (Set 2 pcs)

cream caramel mould (set 2 pcs)
 moule à creme caramel (set 2 pcs)
 forma de pudim flan (set 2 pcs)



ref.	cms.	lts.		Bar Code
870001	8	0,18	6/12	8411922084139

MOLDE ALTO

pie mould
 moule àut manqué
 stampo torta alto
 forma de bolo alta



ref.	cms.	lts.		Bar Code
870820	20x5,5		6/24	8411922086270
870010	26x5,5	2,5	6/24	8411922082623

MOLDE RIZADO

tart mould
 moule à tarte dentelé
 forma de tarta canelada



ref.	cms.	lts.		Bar Code
870006	24x3	1,4	6/24	8411922082586
870007	28x3	1,9	6/24	8411922082593

MOLDE CAKE MINI (Set 2 pcs)

cake mould (set 2 pcs)
 moule à cake (set 2 pcs)
 forma de bolo inglês (set 2 pcs)



ref.	cms.	H.	lts.		Bar Code
870024	15x6,5	4	0,25	6/24	8411922084122

MOLDE SAVARIN

savarin mould
 moule a savarin
 stampo savarin
 forma savarin



ref.	cms.	lts.		Bar Code
870009	24x5,5	1,7	6/24	8411922082616
870926	26x5,5		6/24	8411922086287

TAPETE HORNO

baking sheet
 tapis four
 tapete forno



ref.	cms.		Bar Code
860021	40x30x1,25	6/24	8411922208900

MOLDE 15 CAV. SEMIESFERA

15 half-spheres pan
moule forme semisphere 15 cav.
stampo 15 cav. semi sfera
forma semiesfera 15 cav.



ref.	Ø	H		Bar Code
870042	4	2	6/6	8411922434514

MOLDE 24 CAV. SEMIESFERA

24 half-spheres pan
moule forme semisphere 24 cav.
stampo 24 cav. semi sfera
forma semiesfera 24 cav.



ref.	Ø	H		Bar Code
870043	3	1,5	6/6	8411922434521

MOLDE BOMBÓN 24 CAVIDADES

chocolate pan 24 cups
moule bonbons 24 cavités
forma bombom 24 cavidades

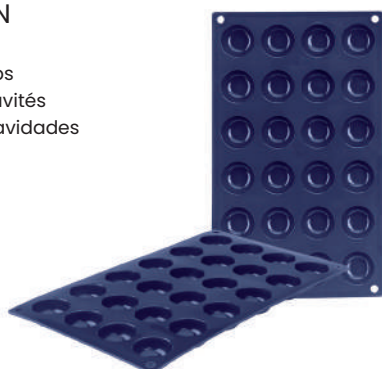

ref.	cms.		Bar Code
870018	3,4x1,6	6/24	8411922083347

MOLDE 6 CAV. SEMIESFERAS

6 half-spheres pan
moule forme semisphere 6 cavités
forma semiesfera 6 cavidades



ref.	cms.		Bar Code
870033	7x3	6/24	8411922083354

MOLDE 12 CAV. CAKES

12 cake cup pan
moule forme cake 12 cavités
forma cake 12 cavidades



ref.	cms.	H.	lts.		Bar Code
870039	7,9x2,9	30	0,025	6/24	8411922083408

MOLDE MUFFIN 6 CAVIDADES

muffin pan 6 cups
plaque à 6 muffin
tabuleiro para 6 muffin



ref.	cms.		Bar Code
870012	6,5x3,7	6/24	8411922082807

MOLDE 6 CAV. SEMIESFERA

6 half-spheres pan
moule forme semisphere 6 cav.
stampo 6 cav. semi sfera
forma semiesfera 6 cav.



ref.	Ø	H		Bar Code
870040	6	3	6/6	8411922434491

MOLDE 8 CAV. SEMIESFERA

8 half-spheres pan
moule forme semisphere 8 cav.
stampo 8 cav. semi sfera
forma semiesfera 8 cav.



ref.	Ø	H		Bar Code
870041	5	2,5	6/6	8411922434507

Varios

max. 230°C min. -60°C



SET 3 MOLDES PARA PANCAKE

3 pancake moulds
3 moules pour pancakes
3 Pancake-Formen
3 moldes para panquecas

GATO - PERRO - KOALA
CAT - DOG - KOALA
CHAT - CHIEN - KOALA
KATZE - HUND - KOALA
GATO - CÃO - KOALA



Con receta
With recipe
Avec recette
Con ricetta
Com receita

ref.	Cms	H	📦	Bar Code
756950	10x14	3	6	8411922456561
	11x12			
	8x13			

SET 2 MOLDES GOMINOLAS ANIMALES+FRUTAS

Set of 2 animal - fruit gummy moulds
Ensemble de 2 moules pour bonbons gélifiés animaux- fruits
Formen für Gummi-Tiere/Früchte im 2er-Set
Conjunto de 2 formas de animais e frutas para gomas

Ibili Design



8 FIGURAS DIFERENTES
8 DIFFERENT SHAPEDS

Con receta
With recipe
Avec recette
Con ricetta
Com receita



ref.	cms.	📦	Bar Code
850100	23x18	6/48	8411922458596

TAPETE DE SILICONA MICROPERFORADO

micro-perforated silicone oven mat
tapis de cuisson en silicone micro-perforé
silikon-backmatte mikroperforiert
tapete de silicone microperfurado

SILICONE

max. 260°C min. -40°C



ref.	Cms	📦	Bar Code
865050	40x30	6/48	8411922453331

TAPETE SILICONA

silicone mat
tapis en silicone
placa silicone



ref.	cms.	📦	Bar Code
865000	40x30	6/72	8411922077247

MOLDE OSITO

teddy bear baking pan
 moule teddy petit ours
 stampo orsetto
 forma ursinho



Con receta
 With recipe
 Avec recette
 Con ricetta
 Com receita



ref.	cms.	H		Bar Code
871600	26x24	5,5	1/6	8411922089714

MOLDE PARA CAKE POPS + 30 palitos

cake pops mould + 30 sticks
 moule pour cake pops + 30 bâtons
 stampo per cake pops + 30 bastoncini
 forma para cake pops + 30 palitos

Con receta
 With recipe
 Avec recette
 Con ricetta
 Com receita



ref.	cms.		Bar Code
872000	30x14	6/24	8411922089752

MOLDE PIRULETAS+24 PALITOS

mould for lollipops+24 sticks
 moule pour sucettes+24 bâtons
 stampo oper lecca-lecca+24 bastoncini
 molde chupa-chupas+24 palitos

Con receta
 With recipe
 Avec recette
 Con ricetta
 Com receita



loli design

ref.	cms.		Bar Code
754900	25	6	8411922087284

PALOS PARA CAKE POPS

cake pops sticks
 bâtons pour cake pops
 bastoncini per cake pops
 palitos para cake pops

PAPER



ref.	cms.	Ø		Bar Code
786510	10	3,5	6/144	8411922092318
786511	11,50	4	6/144	8411922092325
786515	15	3,5	6/120	8411922092332

100 unidades
 50 unidades
 35 unidades

SET 4 FLANEROS C/TAPA APILABLES

set 4 cream caramel stackable moulds with lid
 lot 4 moules crème caramel empilable avec couvercle
 set 4 stampi creme caramel con coperchio impilabili
 jogo 4 formas pudim flan com tampa empiláveis

ibili design

LFGB SILICONE PLASTIC



ref.	cms.	H	📦	Bar Code
871800	8	5,5	6/36	8411922089738

FLANERO GRANDE CON TAPA

pudding mould with lid
 moule à flan avec couvercle
 stampo per crème caramel con coperchio
 forma de pudim flan com tampa

ibili design

LFGB SILICONE

Con receta
 With recipe
 Avec recette
 Con ricetta
 Com receita



ref.	cms.	lts.	H	📦	Bar Code
871700	18	2,0	20,5	1/6	8411922089721

MOLDE CALABAZA

pumpkin mold
 moule citrouille
 stampo melanzana
 forma abóbora



Con receta
 With recipe
 Avec recette
 Con ricetta
 Com receita



3 formas diferentes
 3 different shapes

ref.	Ø	📦	Bar Code
872500	7x7	6/24	8411922091939

MOLDE MINI PANNA COTTA

mini panna cotta mould
 moule pour panna cotta mini
 stampo per panna cotta mini
 molde para mini panna cotta

ibili design

Con receta
 With recipe
 Avec recette
 Con ricetta
 Com receita



ref.	cms.	H	📦	Bar Code
871900	17x30	3	6/36	8411922089745

Crous!

CHAPA DE ACERO
ROLLED STEEL PLATE
ACIER ANTIADHÉRENT
CHAPA DE FERRO



PPG Xylan® PFOA

MOLDE ALTO PERFORADO

perforated pie mould
moule haut perforé
forma de bolo alto perfurado



ref.	cms.	H.	📦	Bar Code
835424	24	4	6/125	8411922441130
835426	26	4	6/36	8411922449129

MOLDE RIZADO MÓVIL PERFORADO

perforated tart mould, loose bottom
moule à tarte dentelé perforé amovible
forma de tarte canelada
perfurado fundo solto



ref.	cms.	H.	📦	Bar Code
835320	20	2,5	6/36	8411922449136
835324	24	2,5	6/36	8411922449143
835328	28	2,6	6/24	8411922441123
835330	30	3	6/36	8411922449150

MOLDE MUFFIN 12 CAV. PERFORADO

perforated muffin pan 12 cups
plaque à 12 biscuits perforé
tabuleiro 12 bolinhos
perfurado



ref.	cms.	H.	📦	Bar Code
835012	35x6	3	6/12	8411922441079

MOLDE CAKE PERFORADO

perforated cake mould
moule à cake perforé
forma de bolo inglês perfurado



ref.	cms.	H.	📦	Bar Code
835125	25x11	7	6/36	8411922441086
835130	30x11	7	6/24	8411922441093

MOLDE RECTANGULAR, MÓVIL PERFORADO

perforated oblong pan
moule rectangulaire perforé amovible
forma rectangular perfurado fundo solto



ref.	cms.	H.	📦	Bar Code
835231	31x21	3	6/18	8411922441109

MOLDE RECTANGULAR ALARGADO MÓVIL PERFORADO

perforated oblong pan, loose bottom
moule rectangulaire perforé amovible
forma rectangular perfurado fundo solto



ref.	cms.	H.	📦	Bar Code
835235	35x11	3	6/18	8411922441116

BANDEJA RECTANGULAR PERFORADA

cookie sheet
plaque à biscuits
blech für kekse
placa para massas



ref.	cms.	H.	📦	Bar Code
835539	39x27	2	6/24	8411922446999



MOLDE DESMONTABLE CORAZÓN MOKA

heart springform
moule démontable coeur
stampo cuore apribile
forma desmontável coraçao



ref.	cms.	H.		Bar Code
826022	22	7,5	6/36	8411922086263

MOLDE DESMONTABLE CUADRADO MOKA

square springform
moule démontable carré
stampo quadrata apribile
forma desmontável quadrada



ref.	cms.	H.		Bar Code
825924	24x24	7	6/36	8411922086256



MOLDE DESMONTABLE CUADRADO CON BASE EXTRA

square springform with extra base
moule démontable carré avec base supplémentaire
stampo quadrato removibile con base extra
forma desmontável quadrada com base extra



ref.	cms.	H.		Bar Code
826517	17x17	8	6/6	8411922090765
826524	24x24	8,3	6/6	8411922090956

MOLDE DESMONTABLE CUADRADO ALTO

square deep springform mould
moule démontable carré profond
viereckige tiefe springform
forma desmontável quadrada alta



ref.	Cms.	H.		Bar Code
821024	24	10	6	8411922453423

MOLDE DESMONTABLE CAKE CON BASE EXTRA

cake springform with extra base
moule démontable cake avec base supplémentaire
stampo plumcake removibile con base extra
forma desmontável cake com base extra



ref.	cms.	H.		Bar Code
827130	30x11	8	6/6	8411922090963

MOLDE DESMONTABLE RECTANGULAR CON BASE EXTRA

oblong springform with extra base
moule démontable rectangulaire avec base supplémentaire
stampo rettangolare removibile con base extra
forma desmontável rectangular com base extra



ref.	cms.	H.		Bar Code
826628	28x18	7	6/12	8411922090772

MOLDE CALABAZA

pumpkin mold
moule citrouille
stampo melanzana
forma abóbora

Con receta
With recipe
Avec recette
Con ricetta
Com receita



ref.	Cms		Bar Code
827500	30x17x3,60	1/6	8411922091694

MOLDE HALLOWEEN 12 CAVIDADES

halloween pan 12 cups
plaque à 12 biscuits
stampo per 12 biscuits
tabuleiro 12 bolos



12 formas diferentes
12 different shapes



ref.	Cms		Bar Code
827700	44x28	6/12	8411922091717

MOLDE 6 CAV. DOUGHNUT

doughnut mould pan 6 cav.
moule 6 cav. doughnut
stampi 6 cav. doughnut
molde 6 cav. doughnut



Con receta
With recipe
Avec recette
Con ricetta
Com receita

ref.	Ø		Bar Code
827300	8	6/24	8411922091670

SET 4 FLANEROS

set 4 cream caramel moulds
lot 4 moules crème caramel
set 4 stampi creme caramel
jogo 4 formas pudim flan



ref.	Ø	H		Bar Code
827800	8	5	6/24	8411922091724

MINI TARTA 3 PISOS

3 mini-tiered cake pans
mini tartes à 3 étages
mini torte a 3 piani
míni bolos 3 andares



mini



Con receta
With recipe
Avec recette
Con ricetta
Com receita

ref.	cms.		Bar Code
827400	6X4,3 - 8,3X4,5 - 10X4,5	1/6/12	8411922091687

MOLDE 12 CAVIDADES NAVIDAD

christmas pan 12 cups
 plaque à 12 biscuits nôel
 stampo per 12 biscuits natale
 tabuleiro 12 bolos



ref.	cms.		Bar Code
828400	36x30	6/12	8411922433647

MOLDE MUFIN 12 CAV CON TAPA +SOPORTE

12 muffin mold with top + support
 moule muffin 12 cavités avec couvercle + support
 stampo muffin 12 cavità con coperchio + supporto
 forma muffin 12 buracos com tampa + suporte



ref.	cms.		Bar Code
828000	37X29	1/6	8411922091762

MOLDE REDONDO INCLINADO

topsy-turvy cake pan
 moule rond incliné
 stampo tondo inclinato
 forma redonda inclinada



ref.	Ø	H		Bar Code
827920	20	10	6/6	8411922091731
827921	21,50	10	6/6	8411922091748
827926	26	10	6/6	8411922091755

MOLDE PANDORO

pandoro mould
 moule pandoro
 pandoro form
 forma pandoro



Antiadherente
 non-stick

Molde para preparar Pandoro, clásico dulce navideño italiano.
 Mould for making Pandoro, a classic italian Christmas sweet bread.

ALUMINIUM

Con receta
 With recipe
 Avec recette
 Con ricetta
 Com receita

Para Pandoro de 1 kg
 For 1 kg Pandoro



ref.	Ø	H		Bar Code
824910	23	17,5	1	8411922453751



MOLDE RIZADO MOVIL

fruit tart mould, loose bottom
moule, à tarte dentelé amovible
forma de tarte canelada com fundo solto



ref.	cms.	H.	lts.	📦	Bar Code
824228	28	3	1,50	6/6	8411922071658

MOLDE RIZADO

tart mould
moule à tarte dentelé
forma de tarte canelada



ref.	cms.	H.	lts.	📦	Bar Code
824328	28	3	1,15	6/6	8411922071672

MOLDE DESMONTABLE REDONDO

round springform mould
moule démontable rond
springform
forma desmontável redonda



ref.	Cms.	H	📦	Bar Code
820110	10	5	6/24	8411922091625
820112	12	4,5	6/144	8411922900125
820114	14	4,8	6/24	8411922458312
820116	16	4,5	6/6	8411922455915
820118	18	6	6/6	8411922451641
820120	20	6,5	6/6	8411922083712
820122	22	6,5	6/6	8411922091632
820124	24	6,5	6/6	8411922900248
820126	26	6,5	6/6	8411922900262
820128	28	6,5	6/6	8411922900286
820130	30	6,5	6/6	8411922453362

MOLDE DESMONTABLE REDONDO ALTO

round deep springform mould
moule démontable rond profond
tiefe springform
forma desmontável redonda alta



ref.	Cms.	H	📦	Bar Code
820920	20	10	6	8411922453409
820926	26	10	6	8411922453416

MOLDE DESMONTABLE REDONDO CON BASE EXTRA

round springform with extra base
moule démontable rond avec base supplémentaire
stampo rotondo removibile con base extra
forma desmontável redonda com base extra



ref.	cms.	H.	📦	Bar Code
826426	26	7	6/6	8411922090758

MOLDE CAKE

cake mould
moule à cake
forma de bolo inglês



ref.	cms.	H.	lts.	📦	Bar Code
820308	7,5x5	3,5	-	12/288	8411922079692
820314	14x7	4,8	0,40	12/216	8411922902143
820320	20x11	8	1,20	6	8411922457988
820325	25x11	8,0	1,70	6/6	8411922902259
820330	30x11	8,0	2,00	6/6	8411922902303
820335	35x11	8,0	2,30	6/6	8411922902358

PISADOR PARA TARTALETAS

tart dough pusher
poussoir à tartelettes
prensa para tartaletas



ref.	cms.	Ø		Bar Code
784400	21	6,8+4	6/36	8411922085068

MOLDE MUFFIN 6 CAVIDADES

muffin pan 6 cups
plaque à 6 biscuits
tabuleiro para 6 bolinhos

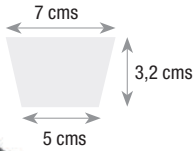

ref.	cms.	H.	Ø		Bar Code
823200	26x18,1	3,2	7	6/72	8411922071283

MOLDE MUFFIN 12 CAVIDADES

muffin pan 12 cups
plaque à 12 biscuits
tabuleiro para 12 bolinhos

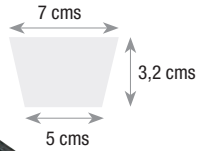

ref.	cms.	H.	Ø		Bar Code
820501	35x27	3,2	7	6/36	8411922781014

MOLDE MUFFIN 24 CAVIDADES MINI

muffin pan 24 cups
plaqué à 24 biscuits
muffinform, 24 vertiefungen
tabuleiro para 24 bolinhos



mini
Ø 5cm

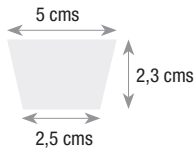

ref.	Cms	Ø	H		Bar Code
820510	38x26	5	2,3	6	8411922453379

MOLDE 4 BAGUETTE / TEJAS

4 baguette / tiles
plaque 4 baguettes / tuiles
placa 4 baguettes / telhas



ref.	cms.		Bar Code
824804	38x33	6/24	8411922083644

MOLDE 3 BAGUETTES/TEJAS

3 baguette / tiles
plaque 3 baguettes / tuiles
form für 2 baguettes / ziegel
placa 3 baguettes / telhas



ref.	cms.		Bar Code
824803	38x24	6/6	8411922447156

MOLDE 2 BAGUETTE / TEJAS

2 baguette / tiles
plaque 2 baguettes / tuiles
placa 2 baguettes / telhas



ref.	cms.		Bar Code
824802	38x16,5	6/24	8411922083637

MOLDE 12 MINI MUFFIN

mini muffin pan 12 cups
plaque à 12 biscuits mini
stampo per 12 mini muffin
tabuleiro para 12 bolinhos mini

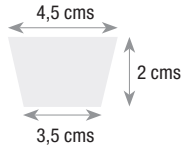

ref.	cms.	H.	∅		Bar Code
826900	25x19	2	4,5	6/36	841192209819

MOLDE MUFFIN 12 CAVIDADES + 12 CAPSULAS

muffin pan 12 cups + 12 capsules
plaque à 12 biscuits + 12 capsules
stampo per 12 muffin + 12 stampi
tabuleiro 12 bolinhos + 12 formas

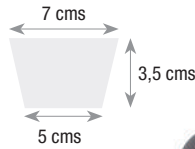

ref.	cms.	H.		Bar Code
827000	39x27	3,5	6/12	8411922090826

MOLDE RECTANGULAR RIZADO MOVIL

along pan loose bottom
moule rectangulaire fond amovible
forma rectangular com fundo solto



ref.	cms.		Bar Code
823528	20x28	6/24	8411922079609

MOLDE RECTANGULAR, FONDO MOVIL

oblong pan, loose bottom
moule rectangulaire fond amovible
forma rectangular com fundo solto



ref.	cms.	H.		Bar Code
823036	35x11	2,5	6/72	8411922068931

MOLDE SAVARIN ALTO

deep savarin mould
moule à savarin haut
forma savarin alta



ref.	cms.	H.		Bar Code
822823	24	10	6/36	8411922068290

MOLDE BIZCOCHO "KUGELHOF"

bundt pan
moule kouglof
forma bundt



ref.	cms.	H.	lts.		Bar Code
820622	22	10	3,0	6/36	8411922782226

FLANERO RIZADO

brioche mould
moule à brioche
forma pudim flan canelada



ref.	cms.	H.	lts.		Bar Code
824121	21	7	1,45	6/36	8411922071634

MOLDE SAVARIN MOKA

savarin mould
moule à savarin
forma savarin



ref.	cms.	H.		Bar Code
821824	24	8,00	6/18	8411922076806

MOLDE CUADRADO

square mould
moule carre
forma quadrada



ref.	cms.		Bar Code
823624	24x24x4,5	6/36	8411922071337

MOLDE PUDIN CON TAPA

pudding mould with lid
moule à pudding avec couvercle
forma pudim com tampa



ref.	cms.		Bar Code
825016	16	4/4	8411922078909
825020	20	4/4	8411922078916

MOLDE TRONCO

tree trunk mould
moule tronc
baumstammform
forma de tronco



Con receta
With recipe
Avec recette
Con ricetta
Com receita



ref.	cms.	H.		Bar Code
827250	26	7	6/6	8411922457698



MOLDE BRAZO GITANO
swiss roll mould
plaque à biscuit roulé
forma de torta

ref.	cms.		Bar Code
822141	41x28x2	6/36	8411922423815

MOLDE SEMICIRCULAR

half round loaf pan
moule à gâteaux demi-lune
forma de bolo semicircular



ref.	cms.	H.	lts.		Bar Code
822530	30	5,5	1,2	6/72	8411922206425

MOLDE DESMONTABLE 2 USOS

springform with tube
moule démontable 2 usages
forma desmontável 2 usos



ref.	cms.	H.		Bar Code
820224	24	6,5	4/4	8411922901245
820226	26	6,5	4/4	8411922901269
820228	28	6,5	4/4	8411922901283

MOLDE PAN

loaf pan
moule à pain
forma de pão



ref.	cms.		Bar Code
822630	30x15x10	6/6	8411922208023

MOLDE HUEVO PASCUA

easter egg shape mould
moule forme oeuf de pâques
forma ovo de páscoa



ref.	cms.	H.		Bar Code
823926	26x21	8,30	6/36	8411922071382

MOLDE CORAZÓN

heart mould
moule forme coeur
forma coração



ref.	cms.	H.		Bar Code
820724	24	4,0	6/36	8411922423785

MOLDE ALTO

pie mould
moule haut
forma de bolo alto



ref.	cms.	H.	lts.		Bar Code
824426	26	4,5	1,95	6/6	8411922071702

MOLDE 12 MADALENAS MOKA

12 cups madeleine pan
plaque madeleine 12 alveoles
tabuleiro 12 madalenas



ref.	cms.		Bar Code
820502	25x21	6/36	8411922781021

ESCALFADOR DE HUEVOS MOKA

egg poacher
pocheuse à oeuf
escalfador de ovos



ref.	cms.		Bar Code
825603	15	6/72	8411922082241

MOLDE PANETTONE

panettone mould
moule panettone
stampo panettone
forma panettone



ref.	cms.	H.		Bar Code
826712	12	10	6/12	8411922090789
826716	16	13	6/6	8411922090796

MOLDE CANUTILLO

cream roll mould
moule à cigarette
forma de rolitos



4 ud.

ref.	cms.		Bar Code
821600	14x2	6/144	8411922904086

MOLDE CORNETE

cream horn
moule cornet
forma de cornucópia



4 ud.

ref.	H.	Ø		Bar Code
821700	12	3,5	6/144	8411922904093

MOLDE HUEVO REDONDO MOKA

round egg mould moka
 moule à oeuf rond moka
 forma para ovo redondo moka



ref.	cms.		Bar Code
824701	10	6/144	8411922079722

MOLDE HUEVO CORAZON MOKA

heart egg mould moka
 moule à oeuf coeur moka
 forma para ovo coração moka



ref.	cms.		Bar Code
824700	10	6/144	8411922079715

MOLDE HUEVO CUADRADO MOKA

square egg mould moka
 moule à oeuf carré moka
 forma para ovo quadrado moka



ref.	cms.		Bar Code
824703	10	6/144	8411922079739

MOLDE OSITO

teddy bear pan
 moule forme petit ours
 forma ursinho



ref.	cms.	H.		Bar Code
823410	10x9,50	2,7	6/144	8411922071313

MOLDE ASPIC

mould aspic
 moule à aspic
 forma aspic



ref.	cms.		Bar Code
824608	8x6	12/288	8411922079708
824600	8x6	12/144	8411922081824

Blister 2 u.

Mini Moka

CHAPA DE ACERO
ROLLED STEEL PLATE
ACIER ANTIADHÉRENT
CHAPA DE FERRO



Antiaderente 1 capa
Non stick 1 coat
Antiadhérent 1 couche
Anhaftbeschichtung 1 lagige
1 camada de antiaderente

MOLDE SAVARIN

savarin mould
moule à savarin
forma savarin



ref.	cms.	H.	lts.		Bar Code
821812	12	5	0,25	6/288	8411922904109

MOLDE CORAZÓN RIZADO

heart tart mould
moule à tart dentelé
coeur
stampo crostata cuore
forma tarta canelada
coraçao



ref.	cms.		Bar Code
828110	10	12/48	8411922093841

MOLDE RIZADO

tart mould
moule à tarte dentelé
forma de tarte canelada



ref.	cms.	H.		Bar Code
820408	8	1,7	12/72	8411922435191
820410	10	1,8	12/72	8411922435207
820412	12	2	12/576	8411922903126

MOLDE CAKE

cake mould
moule à cake
forma de bolo inglês



ref.	cms.	H.	lts.		Bar Code
820308	7,5	3,5	-	12/288	8411922079692
820314	14	4,8	0,4	12/216	8411922902143

MOLDE RIZADO MOVIL

fruit tart mould, loose bottom
moule à tarte dentelé amovible
forma de tarte canelada, fundo solto



ref.	cms.	H.	lts.		Bar Code
822912	12	2	0,2	12/576	8411922209488

MOLDE CANELE

canele mould
moule à cannelé
stampo canele
forma canele

4 ud. ACERO



ref.	cms.		Bar Code
828800	6	6/144	8411922434484

MOLDE DESMONTABLE

springform mould
moule démontable
forma desmontável



ref.	cms.	H.		Bar Code
820110	10	5	6/24	8411922091625
820112	12	4,5	6/144	8411922900125

MOLDE MINI DESMONTABLE CORAZON

heart springform mould
moule forme coeur démontable
forminha desmontável
coraçao



ref.	cms.		Bar Code
824511	11x5	6/144	8411922077384

SARTÉN FORMA COCHE

Car shape frying pan
Poêle forme voiture
Pfanne in form eines Wagen
Sertã forma carro

ibili Design

special special
induction vitro electric gas



ref.	cms.		Bar Code
450405	12x12	6/36	8411922455885

SARTÉN FORMA BUHO

Owl shape frying pan
Poêle forme hibou
Pfanne in form eines Eule
Sertã forma coruja

ibili Design

special special
induction vitro electric gas



ref.	cms.		Bar Code
450406	15x11	6/48	8411922455892

SARTÉN FORMA MONO

Monkey shape frying pan
Poêle forme singe
Pfanne in form eines Affe
Sertã forma macaco

ibili Design

special special
induction vitro electric gas



ref.	cms.		Bar Code
450407	16x16	6/24	8411922455908

SARTÉN FORMA PAYASO

clown shape frying pan
poêle forme pitre
pfanne in form eines clowns
frigideira forma palhaço

special special
induction vitro electric gas



ref.	cms.	H.		Bar Code
450403	15x18	1,5	6/24	8411922447521

SARTÉN FORMA VACA

cow shape frying pan
poêle forme vache
pfanne in form eines einer kuh
frigideira forma vaca

special special
induction vitro electric gas



ref.	cms.	H.		Bar Code
450404	15x16,5	1,5	6/24	8411922447538

SARTÉN FORMA OSITO

bear shape frying pan
poêle forme ours
frigideira forma ursinho

special special
induction vitro electric gas



ref.	cms.		Bar Code
450402	14	6/72	8411922080858

SARTÉN FORMA CORAZÓN

heart shape frying pan
poêle forme coeur
frigideira forma coração

special special
induction vitro electric gas



ref.	cms.		Bar Code
450400	12	6/72	8411922080834

SARTÉN FORMA SONRISA

smile shape frying pan
poêle forme sonrise
frigideira forma sorriso

special special
induction vitro electric gas



ref.	cms.		Bar Code
450401	14	6/72	8411922080841

Clásica

ACERO INOXIDABLE
S. STEEL
INOX.
INOX.



MOLDE DESMONTABLE

springform mould
moule démontable
runde kuchenform
forma desmontável

NEW



INOX /
S.STEEL

ref.	Ø	H	Lts.	☐	Bar Code
650218	18	5,7	1,3	6	8411922083552
650223	23	6,5	2,3	6	8411922083569
650226	26	6,6	3,1	6	8411922083576

SET 6 TAPAS FLANERO

Set of 6 flan cup lids
Set 6 couvercles pour moule à flan
Deckel für puddingform, 6er-set
Conjunto de 6 tampas para flan

INOX /
S.STEEL



ref.	Ø	☐	Bar Code
651000	8,7	6/40	8411922455557

FLANERO CON TAPA Y CIERRES

pudding mould with lid
moule à pudding avec couvercle
forma de pudim flan com tampa e fechos

INOX /
S.STEEL
18/10



ref.	cms.	lts.	☐	Bar Code
651616	16	1,20	6/24	8411922207262
651618	18	1,80	6/24	8411922207279
651620	20	2,60	6/24	8411922207323

FLANERO INDIVIDUAL

cream caramel mould
moule à crème caramel
forma de pudim flan

INOX /
S.STEEL



ref.	cms.	H.	lts.	☐	Bar Code
651005	5	4,0	0,08	24/192	8411922423402
651006	6	5,0	0,10	24/192	8411922423228
651007	7	5,0	0,15	24/192	8411922423235
651008	8	5,0	0,20	24/192	8411922423242
651009	9	5,5	0,30	24/192	8411922115024

MEDIDOR

Measurer
Mesure
Messgerät
Medidor

INOX /
S.STEEL



ref.	ml	☐	Bar Code
681601	100	6/120	8411922455564

FLANERO INOX PRISMA

cream caramel mould
moule à crème caramel
forma de pudim flan

INOX /
S.STEEL



ref.	cms.	H.	lts.	☐	Bar Code
721707	7	5,1	0,15	12/120	8411922079968
721708	8	5,8	0,20	12/120	8411922079975

MOLDE CAKE

cake mould
moule à cake
forma de bolo inglês

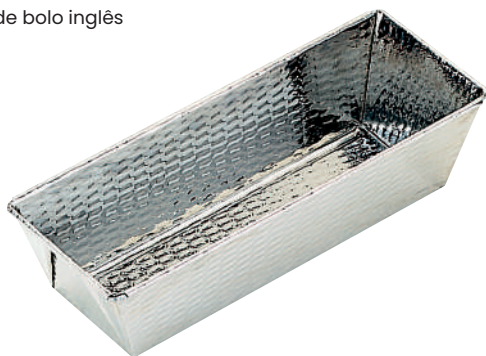

ref.	cms.	H.	lts.		Bar Code
650130	30	7,5	2,0	6/6	8411922759303

MOLDE 3 BAGUETTES / TEJAS

3 baguettes / tiles pan
Plaque 3 baguettes / Tuiles
Form für 3 baguettes / Ziegel
Placa 3 baguettes / Telhas



ref.	Cms		Bar Code
682103	38x25	6/24	8411922455625

EMPANADERA INOX

pan "empanada"
plat à "empanada"
tabuleiro "empanada"



0,3 mm



ref.	cms.	H.		Bar Code
652640	40x30	3,5	4/24	8411922078510
652645	45x35	3,5	4/24	8411922078527

MOLDE CORNETE blister 6 uds.

cream horn
moule cornet
formas de cornucópia



ref.	cms.	∅		Bar Code
802000	11	3,5	12/288	8411922717136

SET 4 MOLDES CANUTILLOS

cream roll mould
moule à cigarette
stampo per cannoli
forma de rolitos

4 ud.



ref.	cms.	∅		Bar Code
730000	14	2	6/72	8411922439755

SET 12 MOLDES CANUTILLOS MINI

cream roll mould mini
moule à cigarette mini
stampo per cannoli mini
forma de rolitos mini

12 ud.



ref.	cms.	∅		Bar Code
802300	6,5	1,6	6/72	8411922440263

MOLDE À BÛCHE TRIANGULAR

triangular christmas cake mould
moule à bûche triangle
dreieckige form für weihnachtskuchen
forma para bolo de natal triangular



DESMONTABLE
REMOVABLE

ref.	cms.	H.		Bar Code
717310	30x9,5	7,3	1/12	8411922447552

MOLDE À BÛCHE SEMICIRCULAR

round christmas log mould
moule à bûche semi-circulaire
dreieckige weihnachts-backform
forma para tronco de natal
semicircular

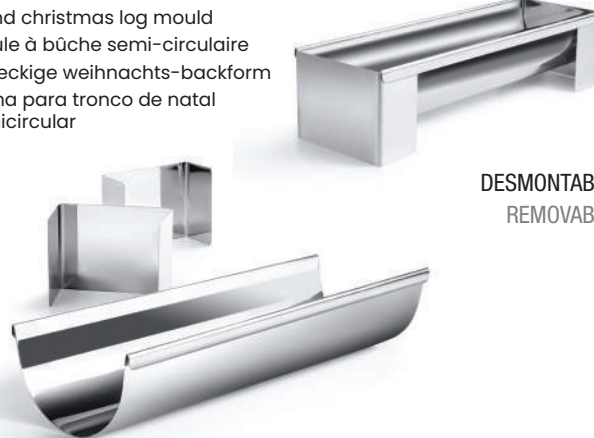

DESMONTABLE
REMOVABLE

ref.	cms.	H.		Bar Code
717300	30x9,5	7,3	1/12	8411922447545

MOLDE EXTENSIBLE

adjustable pastry ring
cercle éxtensible
aro extensível



ref.	cms.	lts.	H.		Bar Code
717216	16-30	6	5,5	1/6	8411922077505

MOLDE EXTENSIBLE RECTANGULAR

ajustable rectangular pastry mould
moule éxtensible rectangulaire
stampo estensibile rettangolare
forma rectangular extensível



ref.	cms.	H.		Bar Code
790600	20x24 - 38x46	6	1/6	8411922090550

MOLDE SEMIESFERA

half sphere mould
moule semiesphère
forma semiesfera



ref.	cms.	H.		Bar Code
723008	8	4	12/288	8411922080605

SOPORTE PARA MOLDE SEMIESFÉRICO-PIRÁMIDE

pyramid and half-sphere mould holder
suport pour moule semiesphère et pyramide
suporte para forma semiesfera y pirámide



ref.	cms.	H.		Bar Code
726500	40x10	5	1/6	8411922083620

ARO
pastry ring
cercle
aro



ref.	cms.	H.		Bar Code
716106	6	6	6/72	8411922070057
716107	7	6	6/72	8411922070064
716108	8	6	6/72	8411922070071
716109	9	6	6/72	8411922070088
716110	10	6	6/72	8411922070095
716112	12	6	6/72	8411922070101

ARO
pastry ring
cercle
aro



ref.	cms.	H.		Bar Code
Set 716050	7+8+10	4,5	6/36	8411922073119
716004	4	4,5	6/72	8411922078732
716005	5	4,5	6/72	8411922078749
716006	6	4,5	6/72	8411922069969
716007	7	4,5	6/72	8411922069976
716008	8	4,5	6/72	8411922069983
716009	9	4,5	6/72	8411922069990
716010	10	4,5	6/72	8411922070002
716012	12	4,5	6/72	8411922070019
716020	20	4,5	6/72	8411922070033
716024	24	4,5	6/72	8411922070040

ARO RECTANGULAR
oblong ring
cercle rectangulaire
aro rectangular



ref.	cms.	H.		Bar Code
722708	8x5	4,50	6/72	8411922084825
722712	12x6	4,50	6/6	8411922080520

ARO INOX CUADRADO
square ring
emporte pièce carré
aro cuadrado



ref.	cms.	H.		Bar Code
716906	6	4,50	6/72	8411922076141
716908	8	4,50	6/72	8411922076165
716910	10	4,50	6/72	8411922076189

ARO ESTRELLA
star ring
cercle étoile
aro estrela



ref.	cms.	H.		Bar Code
718710	10	4,5	6/72	8411922078848

**SET 3 AROS
+ PISADOR 7 CMS (BLISTER)**
set 3 round pastry rings + pusher
lot 3 cercles + poussoir
jogo 3 aros + prensa



ref.	cms.		Bar Code
716090	7-8-10	6/36	8411922081831

ARO TRIÁNGULO

triangle ring
cercle triangle
aro triângulo



ref.	cms.	H.		Bar Code
718508	8	4,5	6/72	8411922078800
718510	10	4,5	6/72	8411922078817

ARO EMPLATAR PEZ

fish ring
cercle poisson
aro peixe



ref.	cms.	H.		Bar Code
725712	12x7	4,5	6/72	8411922082722

ARO CUADRADO BOMBADO

square belly shape ring
emporte pièce carré bombé
aro cuadrado abombado



ref.	cms.	H.		Bar Code
727908	8x8	4,5	6/72	8411922084856
727910	10x10	4,5	6/72	8411922084863

ARO OVAL

oval ring
emporte pièce ovale
aro ovale



ref.	cms.	H.		Bar Code
727808	8x5	4,5	6/72	8411922084832

ARO LAUBURU

basque cross ring
cercle croix basque
aro cruz basca



ref.	cms.	H.		Bar Code
722310	10	4,5	6/72	8411922080131

ARO CHAMPIÑÓN

mushroom ring
emporte pièce champignon
aro cogumelo



ref.	cms.	H.		Bar Code
727708	8x7	4,5	6/72	8411922084818

PISADOR CUADRADO

square pusher
poussoir carré
prensa quadrada



ref.	cms.		Bar Code
718106	6x6	6/72	8411922078251

PISADOR AROS REDONDOS

round pusher
poussoir round
prensa redonda



ref.	cms.		Bar Code
718007	7	6/72	8411922078244

ROLLO PVC PASTELERÍA

pastry pvc ribbon
ruban pvc pâtissier
pvc- tortenrandfolie
rolo pvc pastelaria

20m x 10cm

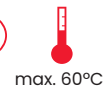

max. 60°C

Espesor | 0,2 mm
Thickness



ref.	Cms	H		Bar Code
773602	20	4,5	1/6	8411922078534
773606	20	6	1/6/24	8411922436136
773608	20	10	1/6/24	8411922453386

Fiberglas

max. 200°C min. -50°C



ARO DE EMPLATAR

pastry ring
cercle
aro



ref.	cms.	H.		Bar Code
752850	7+8+10	4,5	6/72	8411922084214



Aluminio



SET 6 MOLDES PASTEL DE NATA PORTUGUÉS

set 6 moulds for portuguese cream custard tarts
set 6 moules "pastel de nata" portugais
set 6 stampi per pasticcini alla panna ortoghese
set 6 moldes pastel de nata português



ref.	Ø	H		Bar Code
142000	7	3	6/6	8411922439700

MOLDE ANGEL FOOD

angel food mould
moule angel food
stampo angel food
forma angel food

Con receta
With recipe
Avec recette
Con ricetta
Com receita

Desmontable
Detachable
Démontable
Smontavile
Desmontável



ALUMINIO PULIDO
POLISHED ALUMINIUM
ALUMINIUM POLI
ALUMINIO POLIDO

ref.	cms.	H.		Bar Code
787800	25	14	1/6	8411922088083

MOLDE SAVARIN

savarin mould
moule à savarin
forma savarin



ref.	cms.	H.	Its.		Bar Code
140626	26	7,5	2,70	6/6	8411922113266
140628	28	8,3	3,00	6/6	8411922113280

FLANERO INDIVIDUAL

cream caramel mould
moule à crème caramel
forma de pudim flan



ref.	cms.	H.	Its.		Bar Code
140807	7	5	0,13	24/144	8411922115079
140808	8	5	0,18	24/144	8411922115086
140809	9	5,4	0,25	24/144	8411922115093

Acero estañado

ACERO ESTAÑADO
TIN PLATED
FER ÉTAMÉ
FERRO ESTANHADO



MOLDE DESMONTABLE

springform
moule démontable
forma desmontável



ref.	cms.	H.		Bar Code
800122	22	6,5	6/6	8411922700220
800124	24	6,5	6/6	8411922700244
800126	26	6,5	6/6	8411922700268

MOLDE CAKE PROMO

cake mould PROMO
moule à cake PROMO
forma de bolo inglês PROMO



ref.	cms.	H.		Bar Code
810525	25	8	6/6	8411922708004
810530	30	8	6/6	8411922708011
810535	35	8	6/6	8411922203646

MOLDE CANUTILLO

cream roll mould
moule à cigarette
formas de rolitos



6 ud.

ref.	cms.		Bar Code
802200	14x2	6/72	8411922719109

MOLDE PANETTONE DESECHABLE

disposable panettone moulds
moule panettone jetables
stampo panettone monouso
formas panettone descartáveis

5 ud.



PAPER

max. 200°C



ref.	Cms	H		Bar Code
746505	14	10,5	6/6	8411922436877
746509	18	11,5	6/6	8411922436884
746500	7,5	5	6/48	8411922454482

500gr
900gr
90gr Mini (Set 10 pcs)

MOLDE DESECHABLE PARA PAN

disposable bread mould
 moule jetable pour pain
 einweg-brotform
 forma descartável para pão

4 ud.



ref.	Cms	H		Bar Code
215000	18,5x10,5	6	6	8411922454963

MINIMOLDE DESECHABLE INDIVIDUAL

single disposable mould
 moule jetable individuel
 einzelne einwegform
 forma descartável individual

12 ud.



ref.	Cms	H		Bar Code
215005	11	2,5	6	8411922455014

MINIMOLDE DESECHABLE CAKE

disposable mini-mould for cake
 mini-moule jetable cake
 einweg-kuchenform, klein
 miniforma descartável para bolos

12 ud.



ref.	Cms	H		Bar Code
215006	10x5,5	4	6	8411922455021

MOLDE DESECHABLE CAKE

disposable cake mould
 moule jetable cake
 einweg-kuchenform
 forma descartável para bolos

4 ud.



ref.	Cms	H		Bar Code
215001	21x8	5	6	8411922454970
215002	25x10	7	6	8411922454987

MOLDE DESECHABLE SAVARIN

disposable savarin mould
 moule jetable savarin
 einweg-gugelhupform
 forma descartável savarin

4 ud.



ref.	Cms	H		Bar Code
215003	21	6,5	6	8411922454994

MOLDE DESECHABLE ALTO

tall disposable mould
 moule jetable haut
 hohe einwegform
 forma descartável alto

4 ud.



ref.	Cms	H		Bar Code
215004	21	6,5	6	8411922455007

Ceramic

CERÁMICA REFRACTARIA
REFRACTORY CERAMIC

max. 100°C min. -60°C



MOLDE PARA PAN CON TAPA

Loaf pan with lid

Moule à pain avec couvercle

Brotbackform mit Deckel

Forma de pão com tampa

Con receta
With recipe

ibili design



BURDEOS

ref.	cms.	H		Bar Code
685900	24,5x10	10	1/4	8411922459036



*tapa con marcador
score shape id*



BLUE

ref.	cms.	H		Bar Code
685910	24,5x10	10	1/4	8411922459043



Banneton



MOLDE PAN BANNETON BAGUETTE

baguette-shaped banneton bread basket
 moule pain banneton baguette
 banneton-brotform baguette
 forma para pão banneton baguette



Moldes para fermentación que facilitan el trabajo a la hora de manipular masas.
 The banneton proofing moulds make it easier to handle dough.



ref.	Cms	H		Bar Code
680305	44x10	5,5	6/48	8411922449303

MOLDE PAN BANNETON RECTANGULAR

rectangular banneton bread basket
 moule pain banneton rectangulaire
 banneton-brotform rechteckig
 forma para pão banneton rectangular



MOLDE PAN BANNETON CORONA

crown-shaped banneton bread basket
 moule pain banneton couronne
 banneton-brotform kranz
 forma para pão banneton coroa



ref.	Cms	H		Bar Code
680303	29x15	8	6/36	8411922449280

ref.	Ø	H		Bar Code
680304	28	8	6/12	8411922449297

MOLDE PAN BANNETON REDONDO

round banneton bread basket
 moule pain banneton rond
 banneton-brotform rund
 forma para pão banneton redondo



MOLDE PAN BANNETON OVAL

oval banneton bread basket
 moule pain banneton ovale
 banneton-brotform oval
 forma para pão banneton oval



ref.	Ø	H		Bar Code
680300	22	8,5	6/36	8411922449259
680301	25	8,5	6/36	8411922449266

ref.	Cms	H		Bar Code
680302	27x13	6,5	6/36	8411922449273

CUCHILLA MARCADORA PARA PAN

Bread marking knife with a guard
 Lame avec protection pour entailler le pain
 Markiermesser für brot mit schutzhülle
 Faca marcadora para pão com protetor



PLASTIC INOX / S. STEEL

con protector
 with guard

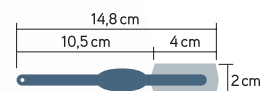

ref.	Cms		Bar Code
681500	15	6/144	8411922455540



FUENTE HORNO RECTANGULAR
rectangular tray
plat rectangulaire
tabuleiro

ref.	cms.	H.	lts.		Bar Code
480723	23x15	5	0,7	6/6	8411922085464
480730	30x18	5	1,6	6/6	8411922085471
480734	34x21	5	2,2	6/6	8411922085488
480740	40x23	6,5	2,9	6/6	8411922085495



FUENTE HORNO RECTANGULAR ALTA
high rectangular tray
plat rectangulaire haut
tabuleiro alto

ref.	cms.	H.	lts.		Bar Code
480840	40x25	7	4,1	6/6	8411922085501



FUENTE HORNO CUADRADA
square tray
plat carré
tabuleiro quadrado

ref.	cms.	H.	lts.		Bar Code
480625	25x22	5	1,8	6/6	8411922085440



FUENTE HORNO OVAL
oval tray
plat ovale
tabuleiro oval

ref.	cms.	H.	lts.		Bar Code
480123	23x16	5	1	6/6	8411922085327
480126	26x18	6	1,5	6/6	8411922085334
480130	30x21	6	2,4	6/6	8411922085341
480135	35x25	6,5	3,2	6/6	8411922085358
480140	40x27	6,5	4,0	6/6	8411922085365

SET 3 FUENTES RECTANGULARES
set 3 rectangular trays
lot 3 plats rectangulaires
jogo 3 tabuleiros



ref.	cms.	H.	lts.		Bar Code
480700	29,5x17	5	1,6	1/3	8411922085457
	34,5x20,5	5	2,2		
	39,3x23	6,5	3		



MOLDE CAKE
cake mould
moule à cake
stampo plumcake
forma de bolo inglês

ref.	cms.	H.	lts.		Bar Code
480024	24x13	7	1,0	6/6	8411922085297
480027	27x14	7	1,5	6/6	8411922085303
480030	30x12	7	2,2	6/6	8411922090017

FUENTE RECTANGULAR CON TAPA

rectangular dish with lid
plat rectangulaire avec couvercle
glasschüssel mit deckel
recipiente rectangular com tampa

NEW

tapa de plástico
plastic cover



ref.	cms.	H.	lts.	📦	Bar Code
687730	30,5x18,6	5,3	1,6	4	8411922459852
687735	35,5x21,5	5,6	2,2	4	8411922459869



MOLDE ALTO
pie mould
moule haut
forma de bolo alto



BOL
bowl
saladier
tigela

ref.	cms.	H.	lts.	📦	Bar Code
480226	26	6	1,2	6/6	8411922085372

ref.	cms.	H.	lts.	📦	Bar Code
480319	19	9	1,8	6/6	8411922085396
480321	21	10	2,5	6/6	8411922085402
480324	24	11	3,5	6/6	8411922085419



FLANERO RIZADO
brioche mould
moule à brioche
forma pudim flan canelada



MOLDE RIZADO
tart mould
moule à tarte dentelé
forma de tarte canelada

ref.	cms.	H.	lts.	📦	Bar Code
480420	20	8	1,05	6/6	8411922085426

ref.	cms.	H.	lts.	📦	Bar Code
480528	28	3,5	1,2	6/6	8411922085433

JARRA DE MEDIDAS

measuring jar
verre mesurer
copo medidor

GLASS



ref.	Lts.	📦	Bar Code
481105	0,500	6/24	8411922087024
481110	1,00	6/24	8411922087031

VASO MEDIDOR

measuring cup
verre mesurer
messbecher
copo medidor

BOROSILICATE



ref.	H	Lts.	Ø	📦	Bar Code
481208	15	0,8	10	6/36	8411922449396
481210	15	1,0	11	6/24	8411922449402

Ceramic



SET 4 MOLDE RAMEQUIN

ramekin mould
ramequin
ramequim



ref.	cms.	H.	Lts.	📦	Bar Code
230010	9	5	0,17	3/3	8411922077377

Chocolate

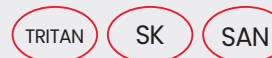

Con receta
With recipe
Avec recette
Con ricetta
Com receita

MOLDE COPA CHOCOLATE 3D

3D chocolate cup mould
moule coupe à chocolat 3D
3D-form für schokoladen schalen
molde para taça de chocolate 3D



ref.	Ø	H.	📦	Bar Code
789750	10	6	6	8411922449945



MOLDE CHOCOBAR

mould
moule
gussform
molde

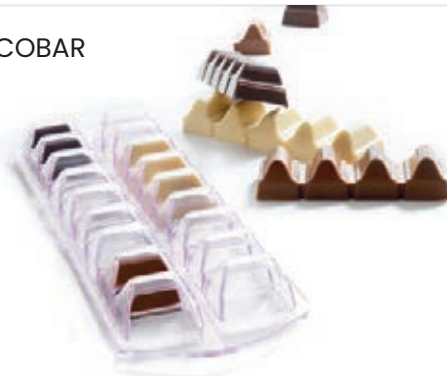

loli design



ref.	Cms	📦	Bar Code
750900	9X27	6/72	8411922441574

MOLDE PARA CAJA CORAZÓN DE CHOCOLATE

heart-shaped chocolate box mould
moule boîte cœur en chocolat
molde caixa coração de chocolate
schachtel schokoladenherz



loli design



ref.	cms.	H	📦	Bar Code
776310	11x11	7	6/48	8411922447125

SET 3 MOLDES HUEVO DE PASCUA

set of 3 3D easter egg moulds
 set 3 moules œuf de pâques 3D
 3er-set aus drei 3D-ostereierformen
 conjunto de 3 moldes para ovos de páscoa 3D

SAN ~~BPA~~



ref.	cms.		Bar Code
776210	12x16 9x11 8x6	6/36	8411922447095



libili design

MOLDE MAGNÉTICO PARA ESFERA DE CHOCOLATE 3D

3D magnetic mould for chocolate sphere
 moule magnétique 3D pour sphère en chocolat
 stampo magnetico 3D per sfera di cioccolato
 forma magnética 3D para esfera de chocolate

Original bola sorpresa
 para todo tipo de fiestas
 Original surprise ball for
 any party

POLYCARBONATE
 MAGNETIC

ref.	∅		Bar Code
828914	14	1/6/12	8411922441390
828918	18	1/6/24	8411922438567



libili design

MOLDE ZAPATO 3D MINI

3D shoe mould mini
 moule chaussure 3D mini
 stampo scarpa 3D mini
 forma sapato 3D mini

SK
 POLYCARBONATE
 MAGNETIC

ref.	cms.	H		Bar Code
792650	12	9,6	1/6	8411922434002
792600	20	17	1/6/24	8411922092141

libili design



MOLDE ABETO 3D

3D fir mould
 Moule sapin 3D
 3D-tannenform
 Forma de abeto 3D

SAN ~~BPA~~

Con receta
 With recipe

ref.	∅	H		Bar Code
850000	11	14,5	1/6/24	8411922458589



libili design



MOLDE CORAZÓN 3D MINI

3D heart mould mini
 moule coeur 3D mini
 stampo cuore 3D mini
 forma coração 3D mini

MAGNETIC

POLYCARBONATE



ibili design

ref.	Cms	H		Bar Code
798800	9	8,5	1/6	8411922434019

BOLSO 3D

3D handbag mould
 moule sac 3D
 stampo borsetta 3D
 forma bolsa 3D

MAGNETIC

POLYCARBONATE



ibili design



ref.	cms.	H		Bar Code
740700	14x22	17	1/6	8411922435085

MOLDE 3D GINGER

3D ginger mould
 moule ginger 3D
 stampo ginger 3D
 forma ginger 3D

MAGNETIC

POLYCARBONATE



ibili design



ref.	H.		Bar Code
746200	20	1	8411922436839

MOLDE GOMINOLAS

gummy bear mould
 moule confiseries
 stampo bonbon
 forma gomas

MAGNETIC

POLYCARBONATE

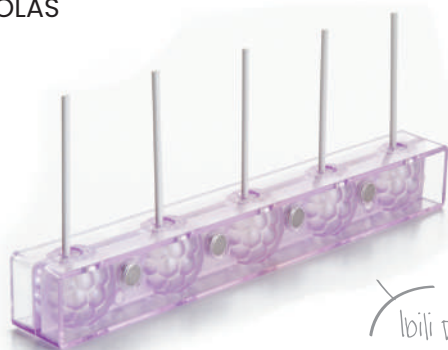

24
+

palitos
 sticks
 batons
 bastoncini
 palitos

ibili design



ref.	cms.	Ø		Bar Code
792200	27	3	6/36	8411922091915

MOLDE BOMBON PROFESIONAL

chocolate pan
moule praliné
stampi per praliné
forma bombom

POLYCARBONATE

Con receta
With recipe
Avec recette
Con ricetta
Com receita



Rizado / Fluted



ref.	cms.	H		Bar Code
799400	27x14	2,5	1/6/36	8411922434224

Cuadrado / Square



ref.	cms.	H		Bar Code
799401	27X14	2,5	1/6/36	8411922434231

Cucharillas / Spoons



ref.	cms.	H		Bar Code
799402	27X14	2,5	1/6/36	8411922434248

Semicircular / Half -sphere



ref.	cms.	H		Bar Code
799403	27X14	2,5	1/6/36	8411922434255

Rectangular / Rectangular



ref.	cms.	H		Bar Code
799404	27X14	2,5	1/6/36	8411922434262

Clásico / Classic



ref.	cms.	H		Bar Code
799405	27X14	2,5	1/6/36	8411922434279

Rectangular / Rectangular



ref.	cms.	H		Bar Code
799304	27X14	2,5	1/6/36	8411922434200

Redondo / Round



ref.	cms.	H		Bar Code
799305	27X14	2,5	1/6/36	8411922434217

MOLDE BOMBON MAGNÉTICO PROFESIONAL

chocolate pan magnetic
 moule praliné magnétique
 stampi per praliné magnetico
 forma bombom magnético



INOX /
S. STEEL

POLYCARBONATE

Con receta
 With recipe
 Avec recette
 Con ricetta
 Com receita

Lagrima / Tear



para bombones decorados
 for signature chocolates



Oval / Oval

ref.	cms.	H		Bar Code
799300	27X14	2,5	1/6/36	8411922434163

ref.	cms.	H		Bar Code
799301	27X14	2,5	1/6/36	8411922434170

Corazón / Heart



ref.	cms.	H		Bar Code
799302	27X14	2,5	1/6/36	8411922434187

MOLDES BOMBON PLÁSTICO
 PLASTIC CHOCOLATE CUPS
 MOULES BONBONS PLASTIQUE
 MOLDE BOMBONS PLÁSTICO

max. 60°C

PET

BPA

SET 3 MOLDES HUEVOS DE PASCUA

set 3 easter egg shaped moulds
 lot 3 moules oeuf de pâques
 set 3 stampi uovo di pascua
 jogo 3 formas ovo de pascua



ref.	cms.		Bar Code
791800	6+7+8	6/72	8411922090871

MOLDE TORTUGA 3D

3D tortoise mould
 molde tortue 3D
 stampo tataruga 3D
 Forma tataruga 3D

max. 60°C

PET

BPA

Con receta
 With recipe
 Avec recette
 Con ricetta
 Com receita



ref.	cms.		Bar Code
796300	15x10	6/6/36	8411922093759

MOLDE À BÛCHE TRONCO

Yule log cake mould
 Moule à bûche tronc
 Bûcheform für weihnachtskuchen
 Forma para bolo de natal tronco

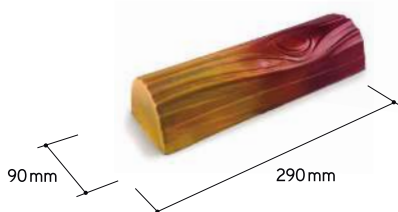

BPA

POLYETHYLENE

Con receta
 With recipe



ref.	cms.	H		Bar Code
850200	30x9,5	6,5	1/6	8411922458602

Flexible Chocolate



MOLDES BOMBON SILICONA

silicone chocolate pan
moule bombons silicone
forma bombons silicona



Con receta
With recipe
Avec recette
Con ricetta
Com receita

MARIHUANA

ibili design



ref.	cms.		Bar Code
860314	10x21x2,5	6	8411922455991

HOJAS



ref.	cms.	Its.		Bar Code
860305	10 x 21 x 2,5	0,01	6	8411922078169

CORAZÓN



ref.	cms.	Its.		Bar Code
860301	10,5 x 21 x 2,5	0,01	6/48	8411922076592

MAR



ref.	cms.	Its.		Bar Code
860307	10,5 x 21 x 2,5	0,01	6/48	8411922083422

DIAM



ref.	cms.	Its.		Bar Code
860303	10,5 x 21 x 2,5	0,01	6	8411922076615

MOLDES BOMBÓN SAN VALENTIN

silicone chocolate pan
moule bombons silicone
stampo per cioccolato
forma bombons silicona

ibili design



ref.	cms.	H		Bar Code
860311	10,5x21	2,5	6/24	8411922088274

MOLDES BOMBÓN CHRISTMAS

silicone chocolate pan
moule bombons silicone
stampo per cioccolato
forma bombons silicona

ibili design



ref.	cms.	H		Bar Code
860312	10,5x21	2,5	6/24	8411922088281

SET UTENSILIOS PARA CHOCOLATINAS

set of utensils for making chocolate candy
set utensiles pour chocolatines
set de utensili per cioccolatini
conjunto de utensilios para chocolatinhos



ref.	cms.		Bar Code
788000	20	6	8411922088106

FONDUE PARA CHOCOLATE Ó QUESO

Fondue for chocolate or cheese
Fondue pour le chocolat ou le fromage
Fondue für schokolade oder käse
Fondue para chocolate ou queijo

CERAMIC

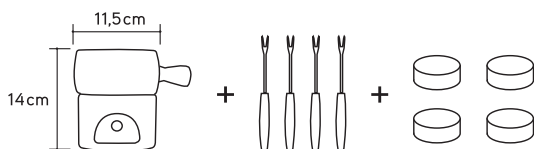

ref.	ml.	H.		Bar Code
707150	410	14	1/6/12	8411922456349

MOLDE 4 MINITABLETAS

Square candy mould
 Moule 4 mini-tablettes carrés
 4 Tüfelchen UNzen-Form
 Forma 4 mini tabletas

loli design



ref.	cms.		Bar Code
850300	18,50x9,5	6/72	8411922458619

MOLDE TABLETA DE CHOCOLATE

Chocolate bar mould
 Moule tablette de chocolat
 Form für Schokoladentafel
 Forma de barra de chocolate

loli design



ref.	cms.		Bar Code
850310	18,5x9,5	6/72	8411922458626

MOLDE TABLETA PIRAMIDE

Pyramid candy mould
 Moule tablette pyramides
 Tafel Pyramiden-Form
 Forma tablete pirâmide

loli design



ref.	cms.		Bar Code
850320	18,2x9	6/72	8411922458633

MOLDE BOMBÓN SARDINAS

Sardine candy mould
 Moule sardines chocolat
 Spülbeckenorganiser mit Spülmittelspender
 Forma bombons sardinhas

loli design



ref.	cms.		Bar Code
860315	22,5x10,5	6/72	8411922458640

MOLDE TABLETA CHOCOLATE SILICONA

chocolate bar mould
 moule tablette de chocolat
 stampo per tavoletta di cioccolato
 forma de barra de chocolat

Con receta
 With recipe
 Avec recette
 Con ricetta
 Com receita



loli design

ref.	cms.	H.		Bar Code
860500	9,5x18,5	1	6/24	8411922087253

CORTADOR EN VIRUTAS QUESO/CHOCOLATE CON TAPA

girolle cheese/chocolate scraper with lid
 girolle à fromage/chocolat avec couvercle
 taglio a saglie per formaggio/ciocolato con coperchio
 cortador em aparas para queijo/chocolate com tampa

INOX /
S. STEEL



ref.	cms.		Bar Code
788100	22	1/6	8411922088137

CAZO BAÑO MARIA

double boiler
 bain Marie
 banho Maria

special
 induction vitro electric gas INOX /
S. STEEL



ref.	cms.		Bar Code
774016	16x9	1/6	8411922079364

CAZO BAÑO MARIA CON TAPA

Double boiler with lid
 bain marie avec couvercle
 Stielkasserolle für wasserbad mit deckel
 banho maria com tampa

special
 induction vitro electric gas INOX /
S. STEEL

tapa de cristal
 Glass lid



ref.	cms.	H		Bar Code
741316	16	9	1/6	8411922457957

BOL SEMIESFÉRICO REPOSTERÍA

semi-round baking bowl
 récipient demi-sphérique pâtisserie
 halbkugelförmige schale gebäck
 tigela semiesférica para pasteleria

1 mm



BOWL SEMICIRCULAR PLEGABLE

semi-circular foldable bowl
 bol semi-circulaie pliabile
 ciotola semicirculara pieghevole
 tigela semicircular dobrável

SILICONE



ref.	cms.	H.	Lts.		Bar Code
730420	20	10	2	6/24	8411922448191

ref.	∅		Bar Code
873000	21	6/6/24	8411922093520

Accesorios

TERMOMETRO-ESPATULA DIGITAL EN SILICONA

digital thermometer
thermomètre numérique
termometro digitale
termômetro digital

max. 300°C min. -50°C

SILICONE



Pila incluida



CUCHARA + ESPATULA

spoon + spatula
cuillère + spatule
cuchiaio + spatola
colher + espátula

ref.	cms.		Bar Code
790900	25	6/48	8411922090581

TERMOMETRO DIGITAL

digital thermometer
thermomètre numérique
termometro digitale
termômetro digital

max. 300°C min. -50°C

PLASTIC



Pila incluida



ref.	cms.		Bar Code
790910	20	6/48	8411922090598

TERMÓMETRO ESPÁTULA PARA CHOCOLATE

chocolate spatula thermometer
thermomètre spatule pour chocolat
termometro spatola per cioccolato
termômetro espátula para chocolate

SILICONE

max. 300°C min. -50°C

GLASS

INOX / S. STEEL

max. 200°C



GRADUATION: 0,1°C

PILA INCLUIDA (LR44)
BATTERY INCLUDED (LR44)

ref.	Cms		Bar Code
790920	32	6/72	8411922439670

TERMÓMETRO DE AZÚCAR

sugar thermometer
thermomètre à sucre
termometro da zucchero
termômetro de açúcar

PANTALLA SIN MERCURIO

mercury free screen
écran sans mercure
quadrante senza mercurio
ecrã sem mercúrio



ref.	cms.		Bar Code
776700	30	6	8411922087932

Turrón



Con receta
With recipe
Avec recette
Con ricetta
Com receita

MOLDE TURRÓN DE CHOCOLATE

chocolate nougat mould
moule à nougat de chocolat
forma nougat de chocolate

SILICONE



ref.	cms.	lts.	📦	Bar Code
860400	20x10x2,5	0,300	6/36	8411922084252

MOLDE TURRÓN DE ALMENDRAS

almond nougat mould
molde touron aux amandes
forma torrão de amêndoas

INOX /
S. STEEL

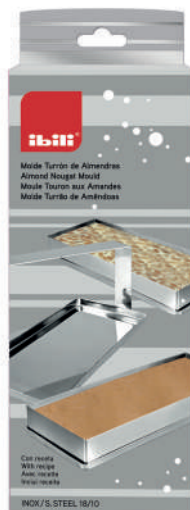

ref.	cms.	H.	📦	Bar Code
753100	9x22	3	1/6	8411922084269

ESTUCHE PARA TURRÓN (2UN.)

nougat box (2un.)
housse pour turrón (2un.)
custodia per torrone (2un.)
estorjo para torrão (2un.)

PAPER
BOARD

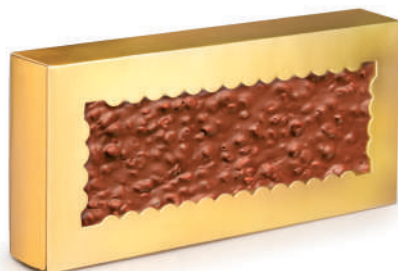

ref.	cms.	H	📦	Bar Code
799100	22X10	2,5	12/72	8411922434132

DESECHABLE SINGLE-USE JETABLE USA E GETTA DESCARTÁVEL

SET 2 MOLDES TURRÓN (TRONCO + ONZAS)

set of 2 nougat moulds (trunk + ounces)
 set 2 moules à nougat (tronc + onces)
 set 2 stampi torrone (tronco + monete)
 conjunto 2 formas torrão (tronco + onças)

loli design



POLYETHYLENE

Con receta
 With recipe
 Avec recette
 Con ricetta
 Com receita



ref.	Cms	H		Bar Code
793501	23x10	2	6/72	8411922092592

SET 2 MOLDES TURRÓN (LISO + ROMBOS)

set of 2 nougat moulds (plain + diamonds)
 set 2 moules à nougat (lisse + losanges)
 set 2 stampi torrone (liscio + rombi)
 conjunto 2 formas torrão (liso + losangos)

loli design



POLYETHYLENE

Con receta
 With recipe
 Avec recette
 Con ricetta
 Com receita



ref.	Cms	H		Bar Code
793500	23X10	2	6/72	8411922092585

SET 2 CAJAS PARA TURRON CASERO

Set of 2 boxes for homemade nougat (turrón)
 Ensemble de 2 boîtes pour nougat maison
 2 Kisten für hausgemachtes turrón als set
 Conjunto de 2 caixas para torrão caseiro

MADERA
 WOOD

PARA PROTEGER Y
 TRANSPORTAR
 TO PROTECT & TO TAKE AWAY



ref.	cms.	H		Bar Code
686500	23x10	4	4/16	8411922459234

SET 2 MOLDES TURRON PORCIONES

set of 2 rectangular turrón moulds
 set de 2 moules à nougat pour portions
 nougat-formen, 2er-set, einzelne portionen
 conjunto de 2 formas para torrão em porções e em barras

ibili design

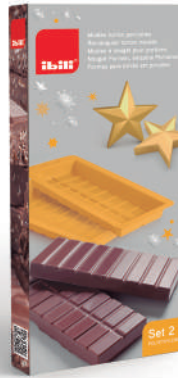

ref.	Cms		Bar Code
793502	23x10,5	6/72	8411922453645

POLYETHYLENE

Con receta
 With recipe
 Avec recette
 Con ricetta
 Com receita



SET 2 MOLDES TURRON ESTRECHO-DOBLE

set of 2 double thin-bar turrón moulds
 set de 2 moules à nougat pour portions et double barre
 nougat-formen, 2er-set, schmal, doppelte portionen
 conjunto de 2 formas para torrão em porções e liso

ibili design



ref.	Cms		Bar Code
793503	23x13,5	6/72	8411922453652

POLYETHYLENE

Con receta
 With recipe
 Avec recette
 Con ricetta
 Com receita



CORTADOR PARA CHEBAKIA DOS MEDIDAS

Double chebakia cutter
 Emporte-pièce de chebakia double
 2-Facher chebakia-schneider
 Cortador de chebakia duplo

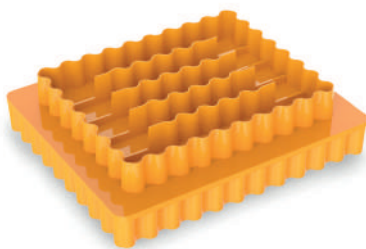

ibili design

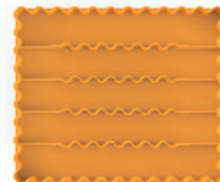

Lado 1 / Side 1: 1:75 x 60 mm Lado 2 / Side 2: 90 x 75 mm

~~BPA~~

~~PLASTIC~~

Con receta
 With recipe
 Avec recette
 Con ricetta
 Com receita



ref.	Cms	H		Bar Code
756450	9,2x7,6	2	6/144	8411922456547

Hielo

SET 6 VASOS DE HELADO + 6 CUCHARITAS

set 6 ice cream glasses + 6 teaspoons
 lot 6 verre à glaces + 6 petites cuillères
 set 6 coppette per gelato + 6 cucchiaini
 jogo 6 copos de gelado + 6 colheres

PAPER BOARD

PLASTIC

ibili design



Desechables
 Disposable
 Jetables
 Monouso
 Descartáveis

ref.	ml		Bar Code
795400	160	6/6/72	8411922093636

MOLDE PARA HELADOS

ice cream moulds
 moule à glace
 forma para gelados

Con receta
 With recipe
 Avec recette
 Con ricetta
 Com receita

60 ml x 4



PLASTIC

Se pueden hacer infinidad de helados utilizando fruta, crema, yogurt y otros ingredientes y también polos de zumos de fruta
 You can make many different ice creams using fruit, cream, yoghurt and other ingredients, and even make fruit juice ice pops
 Il est possible de faire une infinité de glaces différentes avec des fruits, de la crème, du yaourt et d'autres ingrédients, mais aussi des esquimaux de jus de fruits
 Podem fazer-se inúmeras combinações de gelados, utilizando fruta, nata, iogurte e outros ingredientes, e também gelados de sumos de fruta

ref.	cms.	ml		Bar Code
783400	15x10	60	6/48	8411922083521

MOLDE 8 HELADOS CONICOS

8 ice creams mould
 moule à 8 glaces
 stampi per 8 gelatti
 forma para 8 gelados

Con receta
 With recipe
 Avec recette
 Con ricetta
 Com receita

50 ml



PLASTIC

ref.	cms.	ml		Bar Code
783450	20x10	50	6/48	8411922090536

MOLDE 2 HELADOS 3D ÉTÉ
 3D ÉTÉ 2 ice cream mould
 moule 2 glaces 3D ÉTÉ
 3D speiseeis-formen ÉTÉ
 forma para 2 gelados 3D ÉTÉ



LFGB SILICONE

Con recetas
 With recipes

ibili Design



ref.	Cms	ml		Bar Code
783950	10,5x12	2x35	1/6	8411922454758

Incluye 12 palitos reutilizables
 Includes 12 reusable sticks



MOLDES SORBETE (2pcs)
 sorbet moulds (2pcs)
 moule sorbet (2pcs)
 stampi sorbetto (2pcs)
 forma sorvete (2pcs)

SILICONE

Con receta
 With recipe
 Avec recette
 Con ricetta
 Com receita



ref.	Cms.	ml		Bar Code
754000	20	60	6	8411922086317

DISPENSADOR PARA HELADOS ERGONOMIC

ice cream scoop ergonomic
cuillère à glaces ergonomic
eislöffel ergonomic
colher de gelado ergonomic



INOX / S. STEEL PLASTIC

mango tacto suave
soft touch handle



ref.	Ø	H.		Bar Code
763740	4	22	6/48	8411922449167
763760	6	24	6/48	8411922449184

DISPENSADOR DE HELADO CONFORT

ice cream scoop
cuillère à glace
dispenser gelato
colher de gelhado

antiaderente
non stick
antiadhésif
antiaderente
antiaderente



ALUMINIUM



ref.	Cms.		Bar Code
795700	17	6/6/72	8411922093681

DISPENSADOR DE HELADO FUNCTION

ice cream scoop
cuillère à glace
dispenser gelato
colher de gelhado

antiaderente
non stick
antiadhésif
antiaderente
antiaderente



copyright

ALUMINIUM



ref.	Ø	Cms.		Bar Code
795800	5,5	20	6/6/48	8411922093698

RACIONADOR DE HELADO 50 mm.

ice cream scoop, 50 mm.
cuillère à glaces, 50 mm.
colher de gelado, 50 mm.

INOX / S. STEEL 18/10



ref.	cms.		Bar Code
764140	4	6/6	8411922434095
764145	4,5	6/6	8411922434101
764150	5	6/72	8411922203790
764155	5,5	6/6	8411922434118
764160	6,0	6/6	8411922434125

Sopletes

SE SUMINISTRA SIN GAS
SUPPLIED WITHOUT GAS
LIVRÉ SANS GAZ
FORNECIDO SEM GÁS

LFGB

SOPLETE ELEGANCE

culinary torch elegance
chalumeau elegance
torcia de cucina elegance
maçarico elegance



70-100 min.

ref.	lts.	📦	Bar Code
738900	0,028	1/6/24	8411922093469

SOPLETE GOURMET "CLÁSICA"

gourmet torch "Clásica"
chalumeau Gourmet "Clásica"
maçarico Gourmet "Clásica"



70-100 min.

ref.	lts.	📦	Bar Code
704400	0,028	1/6	8411922072341

CABEZAL SOPLETE PROFESIONAL

professional culinary torch
tête chalumeau professionnel
torcia da cucina professionale
cabeça de maçarico profissional

Sistema a rosca
Screw system



180-240 min.

POTENCIA 1850°-1900°
CON GAS-PROPANO

ref.	cms.	📦	Bar Code
786600	16,5	6/24	8411922087550

ADAPTADOR PARA CABEZAL SOPLETE PARA BOTELLAS DE GAS

Torch head adapter for gas bottles
Adaptateur pour tête de chalumeau pour bouteilles de gaz
Adapter Kopfteil Küchenbrenner für Gaszylinder
Adaptador para boquilha de maçarico de cozinha para garrafas de gás

APTO PARA CABEZALES CON VÁLVULA EN417
ADAPTOR FOR TORCHES WITH EN417 VALVUE
ADAPTA SOPLETE ROSCA A BOTELLA SISTEMA CLIP
FROM SCREW SYSTEM TORCH TO CLIP SYSTEM BOTTLE

PLASTIC METALLIC



ref.	∅	📦	Bar Code
684300	4	6	8411922457414

RECAMBIO DE GAS PARA CABEZAL-SOPLETE

gas replacement for culinary torch
rechange de gaz pour tête-chalumeau
ricarica gas per torcia
botija de reposição para cabeça-maçarico

Sistema a rosca
Screw system

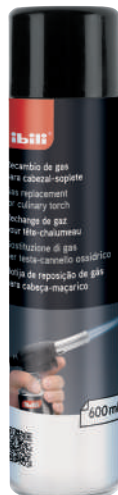

BUTANE + PROPANE

ref.	Lts.	📦	Bar Code
727060	0,600	6/6	8411922087420

SOPLETE GOURMET LUXE

gourmet torch Luxe
chalumeau Gourmet Luxe
maçarico Gourmet Luxe



70-100 min.

ref.	lts.	📦	Bar Code
704450	0,028	1/6	8411922079371

SOPLETE GOURMET "PROFESIONAL"

gourmet torch "professional"
chalumeau gourmet "professional"
maçarico gourmet "professional"



50-120 min.

ref.	lts.		Bar Code
704500	0,063	1/6	8411922072358

SOPLETE MINI HANDY

torch mini
chalumeau mini
torcia da cucina mini
maçarico mini



se suministra sin gas
supplied without gas
livré sans gaz
fornecido sem gás

GAS BUTANO AZUL UNIVERSAL

universal butane gas
gaz butane universal
gáz azul universal



25-40 min.

ref.	cms.	Lts		Bar Code
793400	12	0,01	6/24	8411922092493

ref.	lts.		Bar Code
727020	0,200	6/6	8411922083767

QUEMADOR GRADUABLE

adjustable burner
brûleur réglable
bruciatore regolabile
queimador graduável

INOX /
S. STEEL

No gas included

Support not included



60-80 min.

ref.	Ø	H.	lts.		Bar Code
704700	8,5	8	0,027	1/6	8411922072372

SOPORTE PARA QUEMADOR

support
support
supporto
suporte

INOX /
S. STEEL



ref.	Ø	H		Bar Code
704800	16	11	1/6/24	8411922072389

Sifones-Alu

max. 60°C **LFGB** **ALUMINIUM** EUROPEAN CERTIFICATES

CARGAS DE SIFON DE NATA 10 y 24 pcs.

charges
charges
Ladungen
cargas p/sifão de natas



N₂O

ref.		Bar Code
751000	1/5/30	8411922070910
751050	1/16	8411922449938

10 pcs.
24 pcs.

SIFON DE NATA

cream whipper
siphon à crème
sifão p/natas



ALUMINIUM

ref.	lts.		Bar Code
750805	0,50	1/2/6	8411922070866

SIFON DE NATA

cream whipper
siphon à crème
sahnesiphon
sifão p/natas



2 boquillas
2 nozzles



ref.	lts.		Bar Code
750902	0,25	1/2/6	8411922070880
750905	0,50	1/2/6	8411922070897
750910	1,00	1/2/6	8411922070903

A SET 2 BOQUILLAS

set 2 nozzles
lot 2 douilles
jogo 2 boquilhas

ref.		Bar Code
CNW0102	1	8411922073133

B ADAPTADOR PARA BOQUILLA

nozzle adapter
adaptateur douille
adaptador para boquilha

ref.		Bar Code
CC02	1	8411922073140

C PISTÓN

piston
soupape
pistão

ref.		Bar Code
CPA01	1	8411922073188

D PROTECTOR ENTRADA DE GAS

dust-proof
cap bouchon
protector entrada de gás

ref.		Bar Code
CCA01	1	8411922073157

E SOPORTE DE CARGAS

charge holder
support de remplissage
suporte de cargas

ref.		Bar Code
CH01	1	8411922073164

F JUNTA DE GOMA

gasket
joint
junta de borracha

ref.		Bar Code
CG02	1	8411922073171



CHURRERA A ROSCA – MAQUINA DE COOKIES

cookie & churros gun
 machine à churros chichis et biscuits
 churro-schnecken machine, keksmaschine
 máquina de fazer churros e bolachas

gran capacidad 650 ml
 large capacity 650 ml

PLASTIC

Incluye disco para churros rellenos
 Includes disc for filled churros

3 GROSORES DE CHURROS DIFERENTES
 3 DIFFERENT THICKNESSES OF CHURROS

12 discos
 discs
 disques
 dischi
 discos

NEW

loli design



ref.	Ø	cms.	lts.	📦	Bar Code
687400	8,5	24	0,650	1/6	8411922459777

CHURRERA – MAQUINA DE PASTAS

cookie & churros gun
 machine à churros
 utensile per preparare churros e biscotti
 máquina de fazer massas

Incluye disco para churros rellenos
 Includes disc for filled churros
 Inclut disque pour churros farcis
 Include un disco per churros farciti
 Inclui disco para churros recheados

ALUMINIUM

8 boquillas
 nozzles
 douilles
 bocchette
 boquilhas

13 discos
 discs
 disques
 dischi
 discos



ref.	Lts.	H.	📦	Bar Code
792300	0,200	22	1/6/12	8411922091830

CHURRERA - MAQUINA DE PASTAS

cookie gun
machine à churros
máquina de fazer massas

INOX /
S. STEEL
18/10

PLASTIC



ref.	cms.	H.		Bar Code
769500	12	25	1/6	8411922209730

Accesorios

ROSQUILLERA plástico

donut maker, plastic
machine à donuts, plastique
donuteira, plástico

PLASTIC



ref.		Bar Code
765100	1/12	8411922206357

ROSQUILLERA

doughnut maker
machine à beignets
ciambelliera
aparelho de fazer rosquinhas

INOX /
S. STEEL



Con receta
With recipe
Avec recette
Con ricetta
Com receita



ref.	cms.		Bar Code
734200	18 8,5	1/6	8411922087895

CORTADOR DE DONUTS INOX (BLISTER)

rosocos cutter
découpoir à beignets
cortador de roscas



ref.	Cms.		Bar Code
709200	3,5 + 7,5	6/144	8411922076912
709209	4 + 9	6/96	8411922081954

SET 2 CORTADORES DE DOGNOUT CORAZON

set 2 doughnut heart
set 2 découpoir coeur
lot 2 taglia doughnut cuore
jogo 2 cortadores doughnut coração

Con receta
With recipe
Avec recette
Con ricetta
Com receita



ref.	Ø		Bar Code
794550	5,5 + 8	6/6/72	8411922093582

BUÑOLERA INOX

fritter ladle
louche à beignets
colher para sonhos

INOX /
S. STEEL



ref.	cms.	H.		Bar Code
712100	7,50	2,00	6/72	8411922072556

BUÑOLERA DOBLE

fritter ladle
louche à beignets
mestolo per cambelle et frittelle
colher para sonhos

INOX /
S. STEEL

Con receta
With recipe
Avec recette
Con ricetta
Com receita



ref.	cms.	H.		Bar Code
712150	7,5	2,00	6	8411922087901

SET MOLDES ROSETÓN

set of rose moulds
set moules rosaces
set stampi rosone
conjunto de formas rosácea



ALUMINIUM

Con receta
With recipe
Avec recette
Con ricetta
Com receita



ref.	cms.		Bar Code
787600	25x7	12	8411922088052

MOLDE FLORÓN PEQUEÑO

rossete mould
moule à rosace
forma para rosácea

INOX /
S. STEEL

Con receta
With recipe
Avec recette
Con ricetta
Com receita



ref.	cms.	H.		Bar Code
774356	6,20	4	6/12	8411922084894

MOLDE FLORÓN GRANDE

rossete mould
moule à rosace
forma para rosácea

INOX /
S. STEEL

Con receta
With recipe
Avec recette
Con ricetta
Com receita

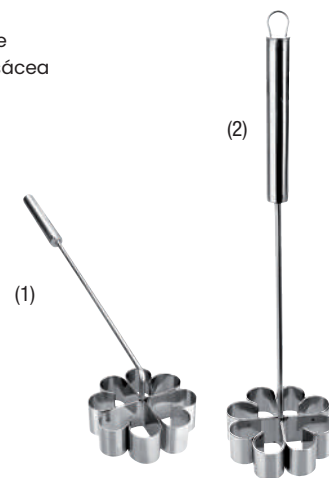

ref.	cms.	H.		Bar Code
(1)774300	9	3	6/12	8411922079487
(2)774350	9	3	6/12	8411922082685

MOLDE FLORÓN CORAZÓN

flower shaped heart mould
 moule fleur cœur
 form für herzförmiges blumengebäck
 forma florão em forma de coração



INOX /
S. STEEL

ibili design

ref.	cms.	H		Bar Code
774610	9,5X10	39,5	6/12	8411922445060

RODILLO CORTADOR DE CROISSANT

croissant cutter roller
 rouleau coupeur de croissants
 croissant-schneider
 rolo para cortar croissants

Con receta
 With recipe
 Avec recette
 Con ricetta
 Com receita

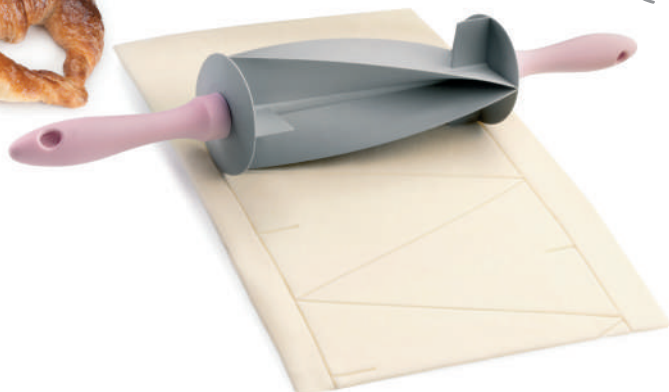

ibili design

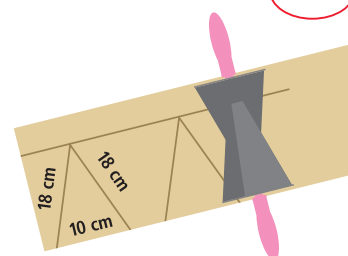

PLASTIC

ref.	cms.		Bar Code
798100	18x10	6/24	8411922433630

RODILLO CORTADOR DE CROISSANT

croissant cutter roller
 rouleau coupeur de croissants
 croissant-schneider
 rolo para cortar croissants

INOX /
S. STEEL

MADERA
WOOD

MINI

Con receta
 With recipe
 Avec recette
 Con ricetta
 Com receita



ref.	cms. △		Bar Code
787701	9x9	6/48	8411922453911

KIT PROFITEROLES
1 CORNETE REDONDO
+ 1 CORNETE RELLENO
+ 5 MANGAS DESECHABLES

kit for cream puffs/eclairs
 kit à petit-choux/eclairs
 kit para petit-choux/bolinhos



INOX /
S. STEEL

ref.		Bar Code
778800	6/6	8411922081183

RODILLO AMASAR
chapa de acero, antiadherente

rolling pin, rolled steel plate, non-stick
 rouleau à pâtisserie, acier antiadhérent
 rolo de massa, chapa de ferro, anti-aderente



ref.	cms.		Bar Code
756700	45	6/6	8411922600223

max. 250°C

NYLON

ESPÁTULA PARA CREPES

crepe spatule
 spatule à crêpes
 spatola stendi crepes
 espátula para crepes



ibili design

ref.	cms.		Bar Code
798700	18	6/6	8411922433999
798714	14	6/6	8411922436129

MOLDE PARA GOFRES

waffle maker
 moule à gaufre
 forma para gofres

electric gas



ref.	Cms.		Bar Code
771100	13x22	1/12	8411922078060

HILADOR DE HUEVO

egg thread funnel
 séparateur d'oeuf
 colino per capelli d'angelo all'uovo
 fabricante de fios de ovos

Con receta
 With recipe
 Avec recette
 Con ricetta
 Com receita



ibili design

copyright



PLASTIC



ref.	Ø	H		Bar Code
749200	9	11,5	6/36	8411922438505

SET MOLDE MANTEQUILLA-PASTAS CON EXPULSOR (6 FORMAS)

butter & cooker mould with ejector(6 moulds)

moule à beurre (6 moules)

molde para manteiga (6 formas)

PLASTIC

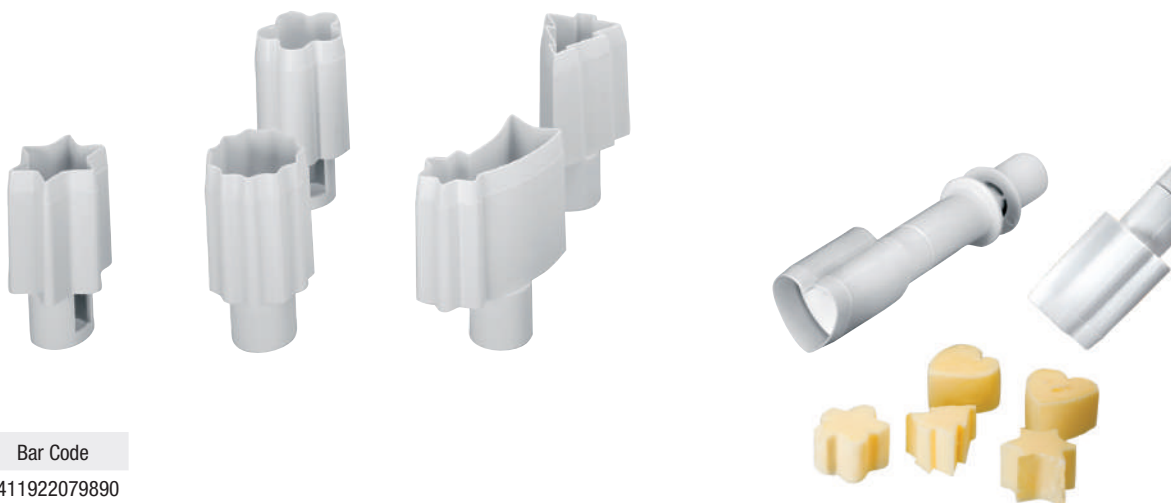

ref.		Bar Code
719800	6/48	8411922079890

MOLDE EMPANADILLAS

dumpling maker

moule à chaussons

forma para salgados

PLASTIC



ref.	Cms.		Bar Code
707700	6+8+10+13	1/12	8411922074895

MOLDE EMPANADILLAS CORAZÓN

heart shaped dumpling maker

moule chausson en forme de coeur

stampo per ravioli a forma di cuore

forma salgados forma coração

PLASTIC



ref.	Cms.		Bar Code
787500	10	1/12	8411922088045

MOLDE EMPANADILLA

dumpling maker

moule à chaussons

forma para salgados

INOX /
S. STEEL



ref.	Cms.		Bar Code
773510	10	1/6	8411922078176
773512	12	1/6	8411922078183

MOLDE HUEVO CUADRADO

square egg mold

moule à oeuf carré

stampo uovo quadrato

forma ovo quadrado

PLASTIC



ref.	cms.		Bar Code
776500	9x7	12	8411922087857

KIT CROQUETAS (10 MANGAS DESECHABLES + 1 CORNETE INOX)

croquettes kit
kit pour croquettes
kit para croquetes

*CAJA EXPOSITORA

display box
boîte présentoir
caixa expositora

Con receta
With recipe
Avec recette
Con ricetta
Com receita

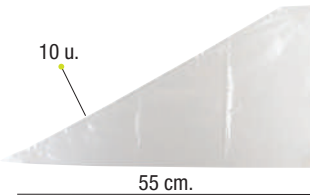

INOX /
S. STEEL



ref.		Bar Code
777000	6/6	8411922072518
* 777000E	12/12	8411922072518

KIT PARA CROQUETAS ECO (10 MANGAS DESECHABLES + 1 CORNETE PLASTICO)

croquettes kit ECO
kit pour croquettes ECO
kroketten-kit ECO
kit para croquetes ECO

Con receta
With recipe
Avec recette
Con ricetta
Com receita

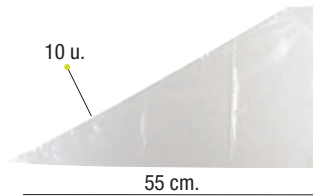

PLASTIC



ref.		Bar Code
781810	6/24	8411922447293

MAQUINA PARA CROQUETAS

Croquette machine
Machine à croquettes
Krokettenmacher
Máquina para elaborar croquetes

Gran cantidad de croquetas de forma rápida
Lots of croquettes quickly

PLASTIC

MADE IN EU

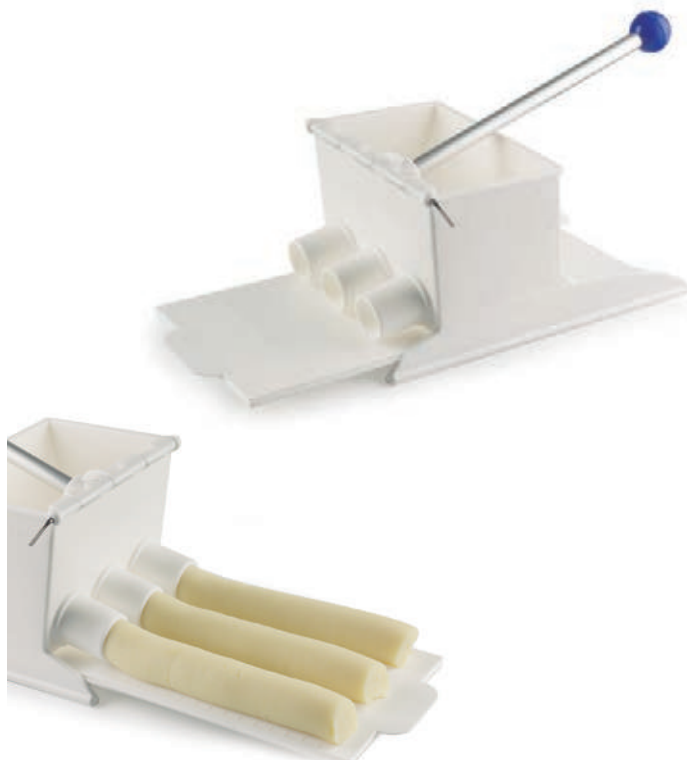

ref.	Cms	H.		Bar Code
706250	28x15	11,5	1	8411922456394

RODILLO CORTAPASTAS CIRCULAR

circular pasta cutter roller
rouleau découpe pâte rond
teigrad für kreisform
rolo cortapastas circular

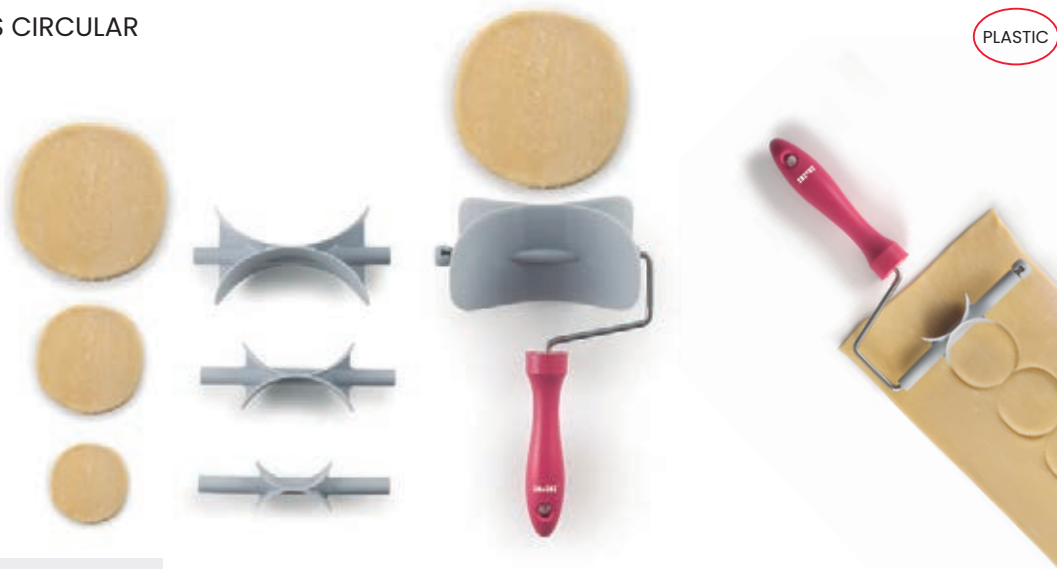

PLASTIC

ref.	Ø		Bar Code
683700	4-6-8-10	1/6/24	8411922457186

MOLDE TARTA "PIE" MINI ENREJADO

Lattice mini pie mould
Moule quadrillage pour tartes mini
Kuchengitter karomuster mini
Forma para tartes com efeito de grelha mini

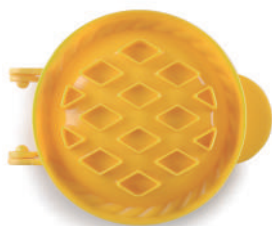

PLASTIC

(1)

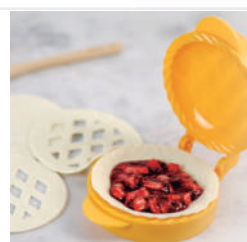

(2)



ref.	Cms.	H		Bar Code
682200	18	4,5	6/48	8411922455847

MOLDE TARTA DE MANZANA "PIE" MINI

Apple mini pie mould
Emporte-pièce tarte aux pommes
Kuchengitter apfelkuchen
Forma para cortar tartes de maçã

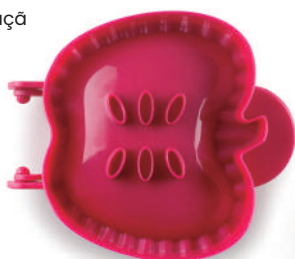

PLASTIC

(1)



(2)



(3)



ref.	Cms.	H		Bar Code
682210	20	4,5	6/48	8411922455854

CORTAPASTAS LINZER RIZADO

linzer cookie cutter fluted
coupe-pâte linzer dentelé
corta massas linzer
canelada



ref.	cms.		Bar Code
774503	5	6/144	8411922079531

CORTADOR RIZADO

fluted cutter
découpoir dentelé
corta massas
canelada



ref.	Cms.		Bar Code
722808	7,5	6/144	8411922080537

RODILLO DECORADOR NÖEL

roller pin with grooves
rouleau de cuisine à fentes
wallholz mit prägung
rolo com nervuras



MADERA
DE HAYA

BEECH
WOOD



ref.	Cms.		Bar Code
747950	39,5x5	6/12	8411922454789

SEED



ref.	Cms.		Bar Code
747951	39,5x5	6/12	8411922454796



VINTER



ref.	Cms.		Bar Code
747952	39,5x5	6/12	8411922454802



HEX



ref.	Cms.		Bar Code
747953	39,5x5	6/12	8411922454819

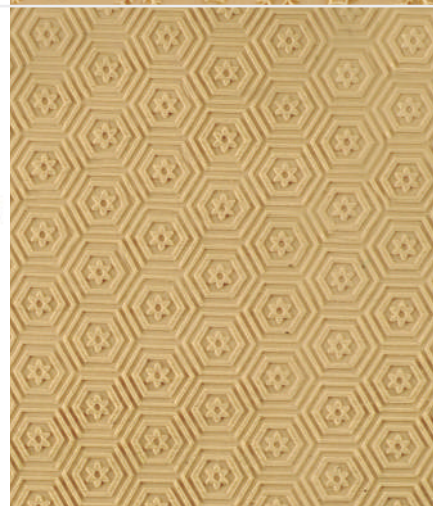

SET 10 CORTAPASTAS LINZER NAVIDAD

set 10 linzer cookie cutters christmas
lot 10 emporte-pièces linzer Noël
set 10 taglia biscotti linzer natale
jogo 10 corta-massas linzer natal

loli design



ref.		Bar Code
742500	1/48	8411922435481

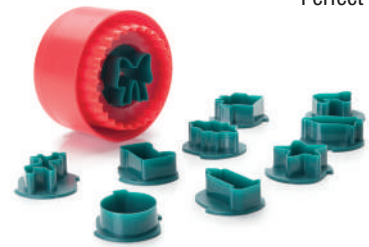

PLASTIC

Formas perfectas
Perfect shapes

SET 10 CORTAPASTAS LINZER BABY

set 10 linzer cookie cutters baby
lot 10 emporte-pièces linzer baby
set 10 taglia biscotti linzer baby
jogo 10 corta-massas linzer baby

loli design



ref.		Bar Code
742501	1/48	8411922435498



PLASTIC

SET CORTAPASTAS LINZER NAVIDAD

set linzer cookie cutters christmas
Lot emporte-pièces linzer Noël
set taglia biscotti linzer natale
jogo corta-massas linzer natal



ref.	cms.		Bar Code
794200	5	12/12/72	8411922093407



SET CORTAPASTAS LINZER NÚMEROS

set linzer cookie cutters numbers
Lot emporte-pièces linzer numéros
set taglia biscotti linzer numeri
jogo corta-massas linzer numeros



ref.	cms.		Bar Code
794201	5	12/12/72	8411922093414



SET CORTAPASTAS LINZER CLÁSICO

set linzer cookie cutters classic
Lot emporte-pièces linzer classique
set taglia biscotti linzer classico
jogo corta-massas linzer clásico



ref.	cms.		Bar Code
794202	5	12/12/72	8411922093421



Profesional

CORTA MASAS
DOUGH CUTTERS
DÉCOUPOIRS
TEIGSCHNEIDER
CORTA MASSAS



max. 200°C



REDONDO LISO (9 pc)

round plain
arrondi lisse
rund glatt
redondo liso



ref.	cms.		Bar Code
784201	2..10	1/6	8411922084580

REDONDO RIZADO (9 pc)

round fluted
arrondi dentelé
rund gewellt
redondo canelado



ref.	cms.		Bar Code
784200	2..10	1/6	8411922084573

CUADRADO RIZADO (9 pc)

square fluted
carré dentelé
quadrat gewellt
quadrado canelado



ref.	cms.		Bar Code
784202	2..10	1/6	8411922084597

CUADRADO LISO (9 pc)

square plain
carré lisse
quadrat glatt
quadrado liso

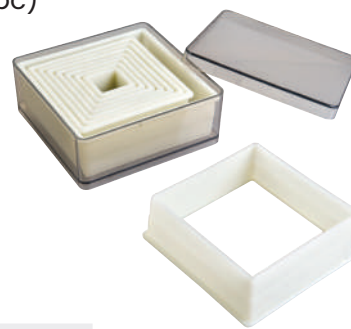

ref.	cms.		Bar Code
784203	2..10	1/6	8411922084603

ESTRELLA LISO (6 pc)

star plain
étoile plain
stern glatt
estrela liso



ref.	cms.		Bar Code
784206	3..12	1/6	8411922084634



CORAZÓN LISO (7 pc)

heart plain
coeur lisse
herz glatt
coração liso



ref.	cms.		Bar Code
784208	2..11	1/6	8411922084658

HEXÁGONO LISO (9 pc)

hexagon plain
hexagone lisse
sechseck glatt
hexágono liso

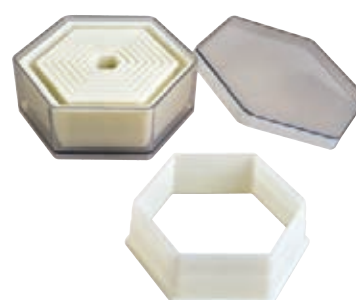

ref.	cms.		Bar Code
784204	1,5..9	1/6	8411922084610

CORTADOR MARCADOR COPO DE NIEVE

snowflake cutter - mould
 emporte-pièce - tampon à biscuit flocon de neige
 ausstecher + stempel - schneeflocke
 cortador - relevo floco de neve

PLASTIC



ref.	cms.		Bar Code
723400	10	6/48	8411922454543

CORTADOR-MARCADOR GINGERMAN

gingerman cutter - mould
 emporte-pièce - tampon à biscuit bonhomme pain d'épice
 ausstecher + stempel - lebkuchenfigur
 cortador - relevo homem de gengibre

PLASTIC



ref.	cms.		Bar Code
723401	10	6/48	8411922454536

CORTADOR MARCADOR ABETO

pine tree cutter - mould
 emporte-pièce - tampon à biscuit sapin de Noël
 ausstecher + stempel - tanne
 cortador - relevo abeto

PLASTIC



ref.	cms.		Bar Code
723402	11	6/48	8411922454550

SET CORTAPASTAS CHICO+CHICA ROMANTIC

set cookie cutter boy + girl romantic
 lot emporte-pièces garçon + fille romantic
 set taglia biscotti bimbo + bimba romantic
 joga corta-massas menino + menina romantic

loili design

Romantic

PLASTIC



ref.	H		Bar Code
789007	10	6/72	8411922090666

CORTADOR CALABAZA

cookie cutter pumpkin
 emporte pièces citrouille
 taglia biscotti zucca
 corta-massas abóbora

loili design

PLASTIC



ref.	cms.	H		Bar Code
789000	12	2	6/72	8411922089912

SET 2 CORTADORES FUTBOL

set 2 cookie cutters soccer
lot 2 emporte-pièces futbol
set 2 taglia biscotti futbol
set 2 corta-massas futebol

loli design



PLASTIC

ref.	cms.		Bar Code
789006	6,5+5,5	6/144	8411922090062

CORTAPASTAS BANDERA

cookie cutter flag
emporte-pièces plateau
formine per biscotti a forma di bandiera
corta-massas bandeira

loli design

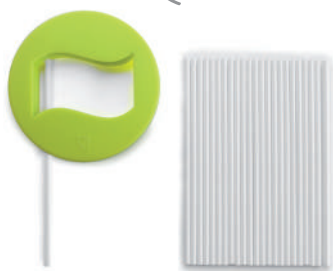

24 palitos
sticks
batons
bastoncini
palitos



PAPER

PLASTIC

ref.	cms.		Bar Code
792100	6x4	6/96	8411922091908

CORTAPASTAS PLÁSTICO

blister 8 uds.
cookie cutters, plastic
coupe-pâte, plastique
corta massas em plástico



ref.		Bar Code
701500	12/96	8411922613001

SET 3 CORTAPASTAS LISOS (BLISTER)

set 3 round plain cookie cutters
lot 3 coupe-pâtes lisses
jogo 3 corta massas lisas



ref.	Cms.		Bar Code
724100	5+6+7	6/144	8411922082067

SET 3 CORTAPASTAS RIZADOS (BLISTER)

set 3 round fluted cookie cutters
lot 3 coupe-pâtes dentelés
jogo 3 corta massas canelados



ref.	Cms.		Bar Code
724000	5+6+7	6/144	8411922082050

CORTAPASTAS CON EXPULSOR JUST MARRIED

cookie cutter just married
 emporte-pièces just married
 taglia biscotti just married
 corta massas just married



PLASTIC

Con receta
 With recipe
 Avec recette
 Con ricetta
 Com receita

ref.	cms.		Bar Code
794700	11x10	6/48	8411922093537

CORTAPASTAS CON EXPULSOR NOVIOS

cookie cutter with ejector groom / bride groom
 emporte-pièces ave pousoir jeune marié
 taglia biscotti con espulsore sposi
 corta massas com espulsore noivo



PLASTIC

Con receta
 With recipe
 Avec recette
 Con ricetta
 Com receita

ref.	cms.		Bar Code
795000	13x11	6/48	8411922093599

CORTAPASTAS ENAMORADOS

cookie cutter couple
 emporte piéces couple
 taglia biscotti couple
 corta massas couple



PLASTIC

Con receta
 With recipe
 Avec recette
 Con ricetta
 Com receita

ref.	cms.		Bar Code
794600	13x7	6/6/72	8411922093322

SET 4 CORTAPASTAS ciudades

set 4 cookie cutters cities
 set 4 emporte-pièces villes
 lot 4 taglia biscotti città
 jogo 4 corta-massas cidades



PLASTIC

ref.	H		Bar Code
789010	10	6/6	8411922434606

SET 10 CORTAPASTAS ABETO

set 10 cookie cutters fir tree
set 10 emporte-pièces sapin
lot 10 taglia biscotti abete
jogo 10 corta-massas abeto



PLASTIC

Con receta
With recipe
Avec recette
Con ricetta
Com receita

ref.	cms.		Bar Code
798900	20	6/72	8411922434040

SET 4 CORTAPASTAS GRANDES CON EXPULSOR FIESTA

set 4 large cookie cutters with ejector fiesta
lot 4 emporte-pièces grands avec poussoir fiesta
set 4 taglia biscotti grandi con espulsore fiesta
jogo 4 corta-massas grandes com expulsor fiesta

Fiesta



PLASTIC

ref.	cms.		Bar Code
789009	8	6X36	8411922090680

CORTAPASTAS CON EXPULSOR PAYASO

clown cookie cutter
emporte-pièces clown
taglia biscotti: pagliaccio
corta massas palhaço



PLASTIC

ref.	cms.		Bar Code
795001	14x12	6/6	8411922435115

CORTAPASTAS CON EXPULSOR HALLOWEEN (4 pc)

cookie cutters with ejector halloween
emporte-pièces avec pousoir halloween
taglia biscotti con espulsore halloween
corta-massas com expulsor halloween



PLASTIC



ref.	cms.		Bar Code
733000	5	6/96	8411922086614

CORTAPASTAS CON EXPULSOR SAN VALENTIN (4 pc)

cookie cutters with ejector st. valentin
 emporte-pièces avec poussoir st. valentine
 taglia biscotti con espulsore s. valentino
 corta-massas com expulsor s. valentim

PLASTIC



ref.	cms.		Bar Code
732900	5	6/96	8411922086607

CORTAPASTAS CON EXPULSOR NAVIDAD (4 pc)

cookie cutters with ejector christmas
 emporte-pièces avec poussoir nôel
 taglia biscotti con espulsore natal
 corta-massas com expulsor natal

PLASTIC



ref.	Cms.		Bar Code
733100	5	6/96	8411922086621

CORTAPASTAS CON EXPULSOR SAFARI

cookie cutter with ejector safari
 emporte-pièces avec poussoir safari
 taglia biscotti con espulsore safari
 corta-massas com expulsor safári

PLASTIC



ref.	cms.		Bar Code
734700	4,5..5,5	6/96	8411922088953

CORTAPASTAS CON EXPULSOR BABY

cookie cutter with ejector baby
 emporte-pièces avec poussoir baby
 taglia biscotti con espulsore baby
 corta-massas com expulsor baby

PLASTIC



ref.	cms.		Bar Code
734900	4,5..5,5	6/96	8411922088977

CORTAPASTAS ABECEDARIO

cookie cutters alphabet
emporte pièces alphabet
taglia biscotti alfabeto
corta massas abecedário

PLASTIC

ABCDEFGHIJK
LMNOPQRSTU
VWXYZ



ref.	H		Bar Code
794800	4,5	6/6/24	8411922093551

CORTAPASTAS NÚMEROS

cookie cutters numbers
emporte pièces numéros
taglia biscotti numeri
corta massas números

PLASTIC

X+-%=

01234

56789



ref.	H		Bar Code
794900	6	6/6/36	8411922093568

SET 2 CORTADORES CON EXPULSOR CÁLIZ+COMUNIÓN

set 2 cookie cutters chalice+communion
lot 2 emporte-pièces coupe+communion
set 2 taglia biscotti calice+comunione
jogo 2 corta-massas cálice+comunhão

PLASTIC



ref.	cms.		Bar Code
788902	10+10	6/6	8411922089905

loli design

SET CORTAPASTAS CON EXPULSOR NIÑO COMUNIÓN + BIBLIA

set pasta cutter with ejector for a child's communion + bible
set emporte-pièces avec poussoir enfant communion + bible
lot stampo con spulsore per dolci bimbo comunione + bibbia
jogo corta-massas com expulsor criança comunhão + bíblia

PLASTIC



ref.	cms.		Bar Code
788903	10x4,8 - 8x5,5	6/24	8411922092608

loli design

CORTAPASTAS CON EXPULSOR NUMEROS

cookie cutters with ejector numbers
 emporte-pièces avec poussoir numéros
 taglia biscotti con espulsore numeri
 corta massas com expulsor números

10 ud.

PLASTIC



ref.	H		Bar Code
793000	4	1/6/24	8411922092455

CORTAPASTAS CON EXPULSOR ALFABETO

cookie cutters with ejector alphabet
 emporte-pièces avec poussoir alphabet
 taglia biscotti con espulsore alfabeto
 corta massas com expulsor alfabeto

26 ud.

PLASTIC



Con receta
 With recipe
 Avec recette
 Con ricetta
 Com receita

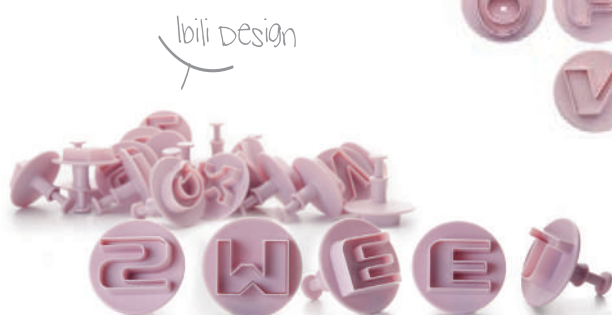

ref.	H		Bar Code
793050	4	1/6	8411922435443

SET 5 CORTAPASTAS GINGER

set 5 cookie cutters ginger
 Lot 5 emporte-pièces ginger
 set 5 taglia biscotti ginger
 jogo 5 corta-massas ginger

PLASTIC



ref.	cms.		Bar Code
794400	4...9	12/12/72	8411922093346

CORTAPASTAS INOX REDONDO LISO
 retractilado (caja metálica indiv.) 11 uds
 (2 - 3 - 4 - 4,5 - 5 - 6 - 6,5 - 7 - 8 - 8,5 - 9 cms)
 s/steel round plain cookie cutters shrunk (indiv. metal box) 11 pcs.
 coupe-pâte inox arrondi lisse sous film (boîte métallique indiv.) 11 pcs.
 corta massas inox redondo liso retractilado (caixa metálica indiv.) 11 pçs

ESTAÑADO



ref.		Bar Code
703500	6/96	8411922068443

CORTAPASTAS REDONDO LISO
 retractilado (caja metálica indiv.) 11 uds.
 2-3-4-4,5-5-6-6,5-7-8-8,5-9 cms.
 cookie cutters, tinplate, round plainshrunk (indiv. metal box) 11 pcs
 coupe-pâte étamé arrondi lisse sous film (boîte métallique indiv.) 11 pcs
 corta massas estanhados redondo liso retractilado (caixa metálica indiv.) 11 pcs

ESTAÑADO



ref.		Bar Code
702700	6/96	8411922207958

CORTAPASTAS "NÚMEROS"
 retractilado (caja metálica indiv.) 9 uds.
 cookie cutters, tinplate, "numbers" shrunk (indiv. metal box) 9 pcs
 coupe-pâte étamé "numéros" sous film (boîte métallique indiv.) 9 pcs
 corta massas estanhados "numeros" retractilado (caixa metálica indiv.) 9 pçs

ESTAÑADO



ref.	cms.		Bar Code
702400	2,5	6/72	8411922207927

CORTAPASTAS "LETRAS"
 retractilado (caja metálica indiv.) 26 uds.
 cookie cutters, tinplate, "letters" shrunk (indiv. metal box) 26 pcs
 coupe-pâte étamé "lettres" sous film (boîte métallique indiv.) 26 pcs
 corta massas estanhados "letras" retractilado (caixa metálica indiv.) 26 pçs

ESTAÑADO



ref.	cms.		Bar Code
702500	2,5	6/96	8411922207934

CORTAPASTAS OCTÓGONO (6 pc)
 octogon cookie cutters (6 pc)
 coupe-pâtes octogone (6 pc)
 tagliapasta ottogono (6 pc)
 corta masas octogono (6pc)

ESTAÑADO



ref.	Cms.		Bar Code
729600	4...9	6/144	8411922086041

CORTAPASTAS TRIANGULAR
 6 PIEZAS 2,5 - 3,5 - 4 - 5,5 - 6 - 7 cms.
 cookie cutters tinplate, triangular
 coupe-pâte étames, triangle
 corta-massas estanhados, triângulo

ESTAÑADO



ref.	cms.		Bar Code
723900	2,5 - 3,5 - 4,5 - 5 - 6 - 7	6/24	8411922082043

CORTAPASTAS RECTANGULAR

rectangular cookie cutter
coupe-pâte petit beurre
corta massas rectangular

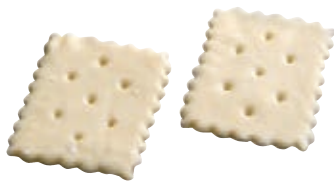

ref.	cms.		Bar Code
774504	4,5x6	6/144	8411922083484

CORTAPASTAS BREZEL

brezel cookie cutter
emporte pièce brezel
corta massas brezel



ref.	cms.		Bar Code
774505	6,5x4,5	6/144	8411922083491

CORTA PASTAS CON EXPULSOR PETIT BEURRE

cookie cutter with ejector petit beurre
emporte-pièces avec poussoir petit beurre
taglia biscotti espulsioni petit beurre
corta-massas com expulsor petit beurre

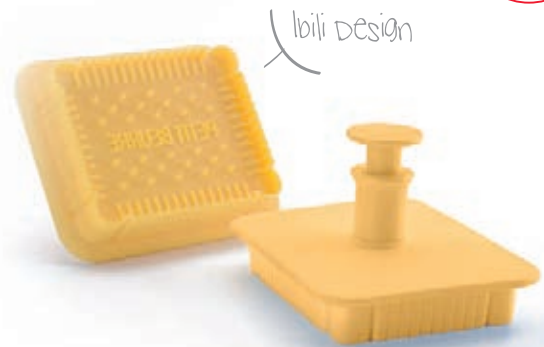

ref.	cms.		Bar Code
776800	7x5,5	6/24	8411922088007

CORTAPASTAS CON EXPULSOR GALLETAS MARIA

Biscuit cutter with maria biscuit ejector
Emporte-pièce avec éjecteur biscuit « maria »
Ausstecher mit ausformhilfe für marien-plätzchen
Cortador de massas com expulsor para bolachas maria



Con receta
With recipe
Avec recette
Con ricetta
Com receita



ref.	Ø	H		Bar Code
681800	7,5	5	6/72	8411922455595

SET 3 CORTADORES MARCADORES CON EXPULSOR COPO DE NIEVE

Set 3 Snowflake shaped marker cutters
Set 3 Emporte-pièces en forme de flocon de neige
Set 3 Ausstecher und stempel, form: schneeflocke
Set 3 Cortadores marcadores com forma de flocos de neve



ref.	Ø		Bar Code
682250	5,5-7,0	6/48	8411922455861

CORTAPASTAS CUPCAKE

cupcake cookie cutters
emporte-pièces cupcake
taglia biscotti cupcake
corta- massas cupcake



ref.	cms.	H		Bar Code
735700	10,3x10,8	2,5	6/72	8411922089110

SET CORTAPASTAS HUEVO DE PASCUA

set cookie cutters
easter egg
lot emporte-pièces
oeuf de pâques
set taglia biscotti
uovo de pasqua
jogo corta-massas
ovo de pásqua



Con receta
With recipe
Avec recette
Con ricetta
Com receita



ref.	cms.		Bar Code
794304	12x10	6/12/72	8411922093391

SET 7 CORTAPASTAS NAVIDAD

set 7 tin plate cookie cutters Christmas
lot 7 coupe-pâtes étamés Noel
jogo 7 corta-massas estanhados Natal



ref.	cms.		Bar Code
723800	7... 11	6/72	8411922082036

SET 7 CORTAPASTAS SAN VALENTIN

set 7 tinplate cookie cutters st. valentine
set 7 emporte-pieces étamés st. valentine
set 7 taglia biscotti stagnato s. valentino
set 7 corta-massas estanhados s. valentin



ref.	cms.		Bar Code
736600	4..9	6/72	8411922091786

SET 4 CORTAPASTAS FAMILIA

set 4 cookie cutters family
lot 4 coupe-pâtes famille
jogo 4 corta massas familia



ref.	cms.		Bar Code
779900	13+5	6/72	8411922082272

SET 7 CORTAPASTAS ANIMALES MARINOS

set 7 tin plate cookie cutters sea animals
lot 7 coupe-pâtes étames animaux de la mer
jogo 7 corta-massas estanhados animais os mares



ref.	cms.		Bar Code
723500	8... 12	6/72	8411922082005

SET 7 CORTAPASTAS HALLOWEEN

set 7 tin plate cookie cutters halloween
lot 7 coupe-pâtes étamés halloween
jogo 7 corta-massas estanhados halloween

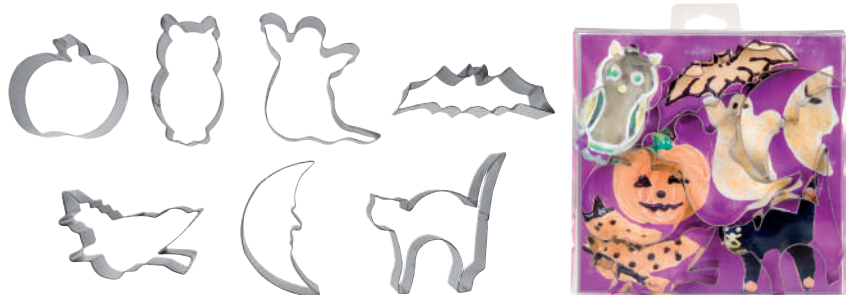

ref.	cms.		Bar Code
723700	7... 10	6/72	8411922082029

SET CORTAPASTAS GINGER CHICO

set cookie cutters ginger boy
lot emporte-pièces ginger garçon
set taglia biscotti ginger bimbo
jogo corta-massas ginger menino

INOX / S.STEEL



INOX / S.STEEL

ref.	cms.		Bar Code
794303	15x10	6/12/72	8411922093384

SET CORTAPASTAS GINGER CHICA

set cookie cutters ginger girl
lot emporte-pièces ginger fille
set taglia biscotti ginger bimba
jogo corta-massas ginger menina

ref.	cms.		Bar Code
794302	14x11	12/12/72	8411922093377

Con receta
With recipe
Avec recette
Con ricetta
Com receita

SET 2 DECORADORES DE TARTA CRUZ SANTIAGO

set 2 st. james cake crosses
set 2 croix tarte saint jacques
jogo 2 cruces tarte santiago

INOX / S.STEEL



lbili design



ref.	cms.		Bar Code
781200	20x10 / 14x7	6/36	8411922082463

CORTAPASTAS

blister 6 uds.
cookie cutters
coupe-pâte
corta massas

INOX / S.STEEL



ref.		Bar Code
801000	6/144	8411922707007

KIT PETIT CHOC KIDS



lbili design



SILICONE PLASTIC

Con receta
With recipe
Avec recette
Con ricetta
Com receita

1 cortador/ 1 Cutter
2 moldes/ 2 molds

ref.	cms.		Bar Code
793700	6,5x5	1/6/24	8411922092639

KIT PETIT CHOC L'AMOUR



lbili design



SILICONE PLASTIC

Con receta
With recipe
Avec recette
Con ricetta
Com receita

1 cortador/ 1 Cutter
2 moldes/ 2 molds

ref.	cms.		Bar Code
793800	7	1/6/24	8411922092646

KIT CRONUTS

SILICONE

PLASTIC

Con receta
With recipe
Avec recette
Con ricetta
Com receita



- 1 cortador 8cms/ Cutter 8cms
- 1 cortador 5,5cms/ Cutter 5,5cms
- 1 boquilla redonda 2mms/ Round nozzle 2mms
- 1 boquilla redonda 4mms/ Round nozzle 4mms
- 1 boquilla relleno 4mms/ Filling nozzle 4mms
- 1 boquilla rizada 4mms/ Star nozzle 4mms
- Adaptador/ Adapter
- 1 manga flexible 35cms/ Flexible 35cms bag
- 1 espátula mini/ Mini spatula

ref.	∅	📦	Bar Code
793100	5,5+8	1/6/48	8411922092462

MOLDE PUSH UP CAKE

push up cake mould
moule push up cake
stampo push up cake
forma push up cake



PLASTIC

Con receta
With recipe
Avec recette
Con ricetta
Com receita

ref.	Cms	📦	Bar Code
792900	9,5x5	6/24	8411922092448

MARCADOR DE PANECILLOS ESTRELLA

bread stamp
marqueur pour petits pains
marcador de pão



PLASTIC



ref.	Cms	📦	Bar Code
774801	7,5	6/144	8411922079838

SET 4 SELLOS PARA GALLETAS/PAN

Set 4 Cookies/bread stamps
Set 4 Marqueur pour biscuit/pain
Set 4 Prägestempel für weihnachtsplätzchen
Set 4 Marcador para bolos/pão

SILICONE

PLASTIC

~~BPA~~



Feliz Navidad
Merry Christmas
Joyeux Noël
Happy New year



ref.	∅	H	📦	Bar Code
681700	6,6	9	6/48	8411922455588

Boquillas



BOQUILLA REDONDA

round decorating tube
douille ronde lise
beccuccio tondo
boquilha redonda

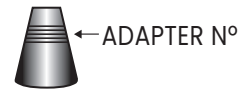

ref.	mark	mm	mm	mm			Bar Code
250000	(1)	0,5	35	17	1	6/6	8411922090970
250001	(2)	1,0	35	17	1	6/6	8411922090987
25001A	(3)	1,5	32	17	1	6/6	8411922090994
250002	(4)	2,0	32	17	1	6/6	8411922091007
250003	(6)	3,0	32	17	1	6/6	8411922091014
250004	(8)	4,0	30	18	1	6/6	8411922091021
250006	(10)	6,0	45	25	2	6/6	8411922091038
250007	(11)	7,0	30	18	1	6/6	8411922091045
250008	(12)	8,0	45	25	2	6/6	8411922091052
250010	(2A)	10,0	50	30	-	6/6	8411922091069
250012	(1A)	12,0	50	30	2	6/6	8411922091076



BOQUILLA ESTRELLA

star decorating tube
douille étoile
beccuccio stella
boquilha estrela

ref.	mark	mm	mm	mm			Bar Code
250104	820	4,0	50	22	2	6/6	8411922091083
250106	821	6,0	50	24	2	6/6	8411922091090
250108	822	8,0	45	23	2	6/6	8411922091106
250109	1M	9,0	50	30	2	6/6	8411922091113
250111	827	11,0	50	30	2	6/6	8411922091120



BOQUILLA ESTRELLA MULTIPUNTA

multiwave star decorating tube
douille étoile multibranche
beccuccio stella multipunte
boquilha estrela multiponta

ref.	mark	mm	mm	mm			Bar Code
250208	199	8	28	21	1	6/6	8411922091137
250210	4B	10	45	23	2	6/6	8411922091144
250212	6B	12	50	30	-	6/6	8411922091151



BOQUILLA ESTRELLA CERRADA

close star decorating tube
douille étoile fermée
beccuccio stella chiusa
boquilha estrela fechada

ref.	mark	mm	mm	mm			Bar Code
250303	30	3,0	33	17	1	6/6	8411922091168
250304	2D	4,0	45	25	2	6/6	8411922091175
250306	2F	9,0	50	30	2	6/6	8411922091182
250310	1B	10,0	53	35	-	6/6	8411922091199
250312	1F	12,0	50	35	-	6/6	8411922091205



BOQUILLA PÉTALOS

petals decorating tube
douille pétales
beccuccio petali
boquilha pétalas

ref.	mark	mm	mm	mm			Bar Code
250606	59	6,0	28	17	1	6/6	8411922091274
250610	61	10,0	30	17	1	6/6	8411922091281
250611	104	11,0	27	16	1	6/6	8411922091298
250616	126	16,0	40	23	2	6/6	8411922091304



BOQUILLA HOJAS

leaves decorating tube
douille à feuilles
beccuccio foglia
boquilha folhas

ref.	mark	mm	mm	mm			Bar Code
250708	68	8,0	30	17	1	6/6	8411922091328
250711	70	11,0	32	20	1	6/6	8411922091335



BOQUILLA CESTA

basket decorating tube
douille tressage
beccuccio cesto
boquilha serra

ref.	mark	mm	mm	mm			Bar Code
250416	2B	16,0	40	23	2	6/6	8411922091229
250420	1D	20,0	45	27	2	6/6	8411922091236



BOQUILLA RELLENO
 bismarck decorating tube
 douille petit chou
 beccuccio ripieno
 boquilha recheado

ref.	mark	mm	mm	mm			Bar Code
250504	264	4,0	90	22	2	6/6	8411922091243
250508	232	8,0	90	22	2	6/6	8411922091250



BOQUILLA FLOR
 flower decorating tube
 douille fleur
 beccuccio fiore
 boquilha flor

ref.	mark	mm	mm	mm			Bar Code
251009	108	9,0	20	30	1	6/6	8411922091366



BOQUILLA HIERBA
 grass decorating tube
 douille pelouse
 beccuccio erba
 boquilha ervas

ref.	mark	mm	mm	mm			Bar Code
250909	233	10,0	25	17	1	6/6	8411922091342



BOQUILLA CONCHAS/CUERDA
 shell/rope decorating tube
 douille coquille/corde
 beccuccio a conchiglia/corda
 boquilha concha/corda

ref.	mark	mm	mm	mm			Bar Code
250908	105	9,0	30	17	1	6/6	8411922091359



SET DE 6 CORNETES NIQUELADOS
 set 6 nickel tubes
 lot 6 douilles nickelés
 jogo boquilhas niqueladas



ref.		Bar Code
000934	1/6	8411922009347

BOQUILLA "Saint Honoré"
 "saint honoré" decorating tube
 douille "saint honoré"
 beccuccio "saint honoré"
 boquilha "saint honoré"



ref.	mark	mm	mm	mm			Bar Code
252300	580	13	40	25	2	6/12	8411922439663

SET 12 BOQUILLAS RUSAS STANDARD

set 12 russian tips standard
 set 12 douilles russes standard
 set 12 beccucci russi standard
 set 12 boquilhas russas standard

ADAPTER REF: 252200

INOX /
S. STEEL

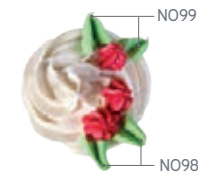
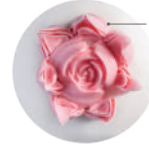
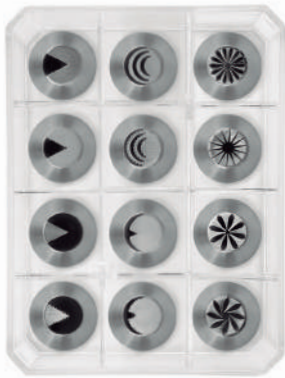

ref.	Ø	H		Bar Code
252000	1,6	4	1/6/24	8411922437614

SET 12 BOQUILLAS RUSAS XL

set 12 russian tips XL
 set 12 douilles russes XL
 set 12 beccucci russi XL
 set 12 boquilhas russas XL

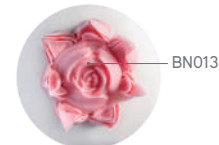

INOX /
S. STEEL

ref.	Ø	H		Bar Code
252001	2,3	4	1/6	8411922437621

SET BOQUILLAS RUSAS NAVIDAD

russian tips christmas
 douilles russes noël
 russische spritztüllen für weihnachten
 boquilhas russas natal

INOX /
S. STEEL

Set 8



ref.	Cms	H		Bar Code
252400	2,4	3,7	6/108	8411922441796

SET 6 BOQUILLAS ESFÉRICAS

set 6 ball tips
set 6 douilles sphériques
set 6 bocchette sferiche
set 6 boquilhas esféricas

INOX /
S. STEEL



N°101



N°102



N°104



N°105



N°106



N°108



ref.	H		Bar Code
252100	6,5	6/72	8411922438536

ADAPTADOR TRIPLE PARA BOQUILLAS GRANDES/RUSAS

Big/Russian triple nozzle adapter
Adaptateur pour grandes/Russes douilles triple
Adattatore per beccucci grandes/Russi triplo
Adaptador para boquilhas grandes/Russas triple

PLASTIC



ref.	Cms		Bar Code
252200	2,3	6/216	8411922439656

ADAPTADOR STANDARD Nº 1 PEQUEÑAS (2pc)

small standard nozzle adapter (2pc)
adaptateur standard pour petit douilles (2pc)
adattatore standard per beccucci piccolo (2pc)
adaptador standard para boquilhas pequenas (2pc)



ref.	cms.		Bar Code
760603	3x2,5	6/144	8411922090024

ADAPTADOR PARA BOQUILLAS Nº2

nozzle adapter
adaptateur pour douilles
adattatore per beccucci
adaptador para boquilhas

PLASTIC



ref.		Bar Code
760604	6/144	8411922091847

CEPILLO LIMPIA CORNETES (BOLSA 2 UN.)

tube cleaning brush
brosse à douille
escova limpa boquilhas



ref.	cms.		Bar Code
760400B	10,5	6	8411922797008

JUEGO DECORADOR NOVELES
 (6 cornetes decoración niquelados + adaptador + manga 25 cm.)

decorating set (6 nickel plated nozzles + coupler + pastry bag 25 cm)
 ensemble de décoration (6 douilles niquelées + adaptateur + poche 25 cm)
 jogo decorador (6 boquilhas niqueladas + adaptador + saco pasteleiro 25 cm)



ref.		Bar Code
760700	1/50	8411922619003

DECORADOR MANGA PLÁSTICO
 5 BOQUILLAS (blister)

icing bag, plastic, 5 nozzles
 poche à décorer, plastique, 5 douilles
 saco pasteleiro em plástico, 5 boquilhas



JERINGA DE REPOSTERIA + 8 BOQUILLAS

icing set + 8 nozzles
 seringue à pâtisserie + 8 douilles
 siringa da pasticciere + 8 bocchette
 seringa de pasteleiro + 8 boquilhas



ref.		Bar Code
756300	12/144	8411922600193

ref.	Cms.		Bar Code
744500	18	6/72	8411922436464

MANGA PASTELERA FLEXIBLE + 6 BOQUILLAS

flexible pastry bag + 6 nozzles
 poche pâtissière + 6 dovilles
 sacchetti flessibile + 6 beccucci
 saco pasteleiro flexível + 6 boquilhas



ref.	cms.		Bar Code
790100	40	12/96	8411922090437

SET 24 CORNETES

set 24 nozzles
set 24 douilles
jogo 24 boquilhas



ref.		Bar Code
771900	1/6	8411922077995

KIT PRACTIC (10 mangas desechables 30 cm. +6 cornetes)

kit practic (10 disposable bags
30 cm. +6 nozzles)
kit practic (10 poches jetables
30 cm. +6 douilles)
kit practic (10 sacos descarta-
véis 30 cm. + 6 boquilhas)



ref.		Bar Code
000946	1/6	8411922009460

SET DE 6 CORNETES PLÁSTICO

set 6 plastic nozzles
lot 6 douilles plastique
jogo 6 boquilhas de plástico



ref.		Bar Code
768300	6/12	8411922208955

SET DECORACIÓN COOKIES Y CUPCAKES

cookie & cupcake decorating kit
kit décoration pour cookies et cupcakes
kit de decoração cookies e cupcakes

3 FUELLES DECORADORES + 1 BIBERÓN
3 squeeze bottles + 1 straight side bottle
3 embonts décoration + 1 flacon souple
3 foles decoração + 1 biberão



ref.		Bar Code
782800	1/4	8411922083194

SET DE CUPCAKES LUXE

cupcake set luxe
set de cupcakes luxe
set per cupcake luxe
conjunto de cupcakes luxe



6 CÁPSULAS CUPCAKE/MOULDS

1 vaciador cupcake/corer
1 biberón/bottle
3 fuelles/bellows
1 espátula/spatula
3 boquillas/nozzles

ref.		Ø	Bar Code
735500	6/24	6	8411922089035

LAPIZ DECORADOR

decorating pen
crayon à décorer
penna decorativa
lápiz para decorar



ref.	Cms.	📦	Bar Code
744700	12	6/24	8411922436488

MANGA DESECHABLE

disposable pastry bags
poches à décorer jetables
Sacchetti monouso
sacos de pasteiro descartáveis

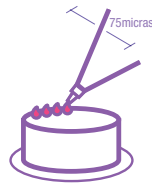

10 UDS

100 UDS

ref.	cms.	📦	Bar Code
760030	30	1/12	8411922620306
760045	40	1/12	8411922620450
760055	55	1/12	8411922208962

ref.	cms.	📦	Bar Code
760030E	30	1/10	8411922435863
760040E	40	1/10	8411922435870
760055E	55	1/10	8411922435887

MANGA DESECHABLE (caja expositora) (100 un.)

disposable pastry bag (display box) (100 un.)
poches à décorer jetables (boîte présentoir) (100 un.)
sacos de pasteiro descartáveis (caixa expositora) (100 un.)



ANTIDESLIZANTE

not slippery
andtdérapant
anti-deslizante



ref.	cms.	📦	Bar Code
773740	40	1/4	8411922078930
773755	55	1/10	8411922078947

MANGA DESECHABLE DOBLE

double disposable pastry bags
poches à décorer jetables double
doppelter einweg-spritzbeutel
sacos de pasteiro descartáveis duplo

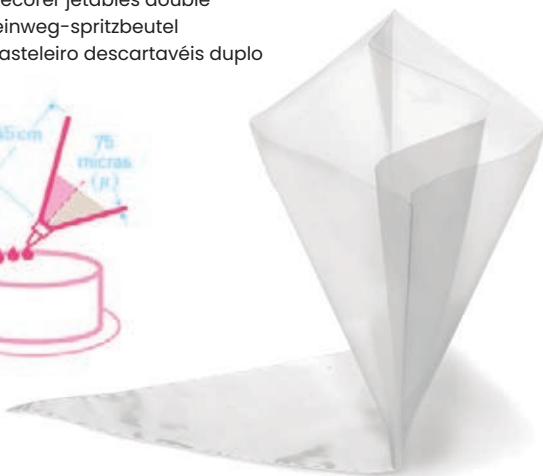

ref.	Cms	📦	Bar Code
760245	45	6/72	8411922448870

SOPORTE DE MANGAS

pastry bag holder
support pour poche à décorer
suporte sacos pasteiro



ref.	cms.	📦	Bar Code
771400	10x24	1/4	8411922077919

Flex



max. 100°C
min. -40°C



MANGA FLEXIBLE + 2 BOQUILLAS RELLENO

Flexible pastry bag + 2 bismark nozzles
Poche pâtissière + 2 choux dovilles
Sachetti flessibile + 2 beccucci ripiero
Saco pasteleiro flexível + 2 boquilhas recheado

Alta resistencia y flexibilidad
High resistance and flexibility
Haute résistance et flexibilité
Alta resistência e flexibilidade



ref.	cms.		Bar Code
792500	35	6/72	8411922091984

MANGA REPOSTERÍA FLEXIBLE

flexible pastry bag
poche pâtissière flexible
saco de pasteiro flexível

Alta resistencia y flexibilidad
High resistance and flexibility
Haute résistance et flexibilité
Alta resistência e flexibilidade



ref.	cms.		Bar Code
752734	34	1/12	8411922084061
752740	40	1/12	8411922084078
752745	45	1/12	8411922084085
752750	50	1/12	8411922084092
752755	55	1/12	8411922084108
752760	60	1/12	8411922084115

MANGA FLEXIBLE DOBLE

double flexible pastry bag
poche pâtissière flexible double
sacchetti flessibile doppio
saco de pasteiro flexível duplo

Alta resistencia y flexibilidad
High resistance and flexibility
Haute résistance et flexibilité
Alta resistência e flexibilidade



ref.	cms.			Bar Code
789440	40	760603	6/72	8411922090031

MANGA FLEXIBLE TRIPLE

triple flexible pastry bag
poche pâtissière flexible triple
sacchetti flessibile triplo
saco de pasteiro flexível triple

Alta resistencia y flexibilidad
High resistance and flexibility
Haute résistance et flexibilité
Alta resistência e flexibilidade



ref.	cms.		Bar Code
798640	40	1/6/72	8411922433975

MANGAS REPOSTERÍA, NYLON

pastry bags
poche à décorer
sacos de pasteleiro



ref.	cms.	📦	Bar Code
756830	30	6/6	8411922774306
756835	35	6/6	8411922774351
756840	40	6/6	8411922774405
756845	45	6/6	8411922774450
756850	50	6/6	8411922774504
756860	60	6/6	8411922068610

BIBERON

squeeze bottle
flacon verseur souple
recipientes para molhos

con graduación
with graduation

PLASTIC

ref.	lts.	📦	Bar Code
773901	0,125	12/12	8411922084566
773902	0,250	12/12	8411922079333
773904	0,400	12/12	8411922079340
773907	0,700	12/12	8411922079357



BIBERON PARA BAÑAR BIZCOCHOS

Bottle for bathing sponge cake
Flacon souple verseur pour imbiber les biscuits
Saugflasche für kuchenüberzug
Biberão para banhar bolos

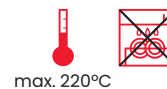

BPA

PLASTIC

ref.	Lts.	H	📦	Bar Code
681405	0,500	22	6/96	8411922455519
681410	1,000	28	6/96	8411922455526



BOL REPOSTERÍA

mixing bowl
bol à pâtisserie
tigela de pastelaria



ref.	cms.	📦	Bar Code
726618	18	6/24	8411922083651
726624	24	6/24	8411922083668

Base antideslizante
Non-slip base
Base antidérapant
Baseie antideslizante

BÁSCULA DIGITAL 15 Kg

electronic kitchen scale 15 Kg
balances de cuisine électroniques 15 Kg
elektrische küchenwaage 15 Kg
balança eletrônica de cozinha 15 Kg

GLASS



3 x AAA
not included

ref.	cms.	📦	Bar Code
708450	24x20	1	8411922457230

BASCULA DIGITAL SUPERFINA

digital scale super thin
balance numérique ultra fine
bilancie da cucina digitale
balança digital super fina

INOX /
S. STEEL



Included



Grad 1g

Max 5kg

ref.	cms.	📦	Bar Code
790800	21,5x17	1/6	8411922090574

BASCULA DIGITAL MINI

digital scale mini
balance numérique mini
digitale mini-waage
balança digital mini

INOX /
S. STEEL



2 x AAA
included

ref.	cms.	📦	Bar Code
734600	18X14	1/6/36	8411922441826

BASCULA DIGITAL

digital scale
balance numérique
digitale waage
balança digital

GLASS



3V

1 x CR2032
included

ref.	cms.	📦	Bar Code
734810	23X15	1/5/20	8411922441819

VELA

Candle
Bougie
Kerze
Vela

ref.	H	📦	Bar Code	N°
786300N	9,5	12//288	8411922455670	0
786301N	9,5	12//288	8411922455687	1
786302N	9,5	12//288	8411922455694	2
786303N	9,5	12//288	8411922455700	3
786304N	9,5	12//288	8411922455717	4
786305N	9,5	12//288	8411922455724	5
786306N	9,5	12//288	8411922455731	6
786307N	9,5	12//288	8411922455748	7
786308N	9,5	12//288	8411922455755	8
786309N	9,5	12//288	8411922455762	9



SET 5 VELAS CORAZÓN

set 5 candles heart
lot 5 bougies coeurs
set 5 candele cuore
jogo 5 velas coração



ref.	Cms.		Bar Code
786203	7	12/288	8411922086362

SET 5 VELAS SONRISA

set 5 candles smiles
lot 5 bougies sourises
set 5 candele smile
jogo 5 velas sorriso

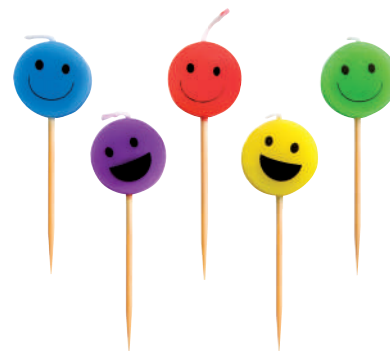

ref.	Cms.		Bar Code
786201	7	12/288	8411922086355

VELA COCHE

candle car
bougie voiture
candela auto
vela carro



ref.	Cms.		Bar Code
786214	7,5	12/360	8411922088694

VELAS MONSTRUOS

candle monsters
bougie monstres
candela mostri
vela monstros



ref.	Cms.		Bar Code
786215	8	12/360	8411922088700

VELAS ANIVERSARIO (palos + numeros)

birthday candles (sticks + numbers)
bougies d'anniversaire
velas de aniversário



ref.		Bar Code
706400	12/48	8411922072822

VELAS ANIVERSARIO (24 uds.) + SOPORTE (12 uds.) (blister)

birthday candles
(24 pcs) + holders (12 pcs)
bougies d'anniversaire
(24 pcs) + supports (12 pcs)
velas de aniversário
(24 uds) +
suportes (12 uds)



ref.		Bar Code
756200	12/48	8411922600186

VELA BALÓN

candle ball
bougie ballon football
candela pallone da calcio
vela bola de futebol



ref.	Cms.		Bar Code
786206	8	12/288	8411922086393

VELA HAPPY BIRTHDAY

candle happy birthday
bougie happy birthday
candela happy birthday
vela happy birthady



ref.	Cms.		Bar Code
786209	7	12/288	8411922086423

Professional



ESPÁTULA RECTA

straight spatula
spatule droite
spatola diritta
espátula reta

ref.	cms.	H		Bar Code
737810	10	2	6/144	8411922440560
737815	15	3,0	6/144	8411922092158
737820	20	3,0	6/144	8411922092165
737825	25	3,5	6/96	8411922092172
737830	30	4,0	6/72	8411922092189



ESPÁTULA ACODADA

angled spatula
spatule coudée
spatola a paletta
espátula curva

ref.	cms.	H		Bar Code
737910	10	2	6/144	8411922440577
737915	15	3	6/144	8411922092196
737920	20	3	6/144	8411922092202
737925	25	3,5	6/96	8411922092219
737930	30	4,0	6/72	8411922092226



SET 3 ESPATULAS MINI

Set of 3 mini-spatulas
Set 3 spatules mini
Set 3 mini spatole
Conjunto 3 espátulas míni

ref.	cms.	H		Bar Code
738000	10	2	6/72	8411922092233



PALETA RECTANGULAR XL

rectangular spatula XL
spatule rectangulaire XL
spatula rettangolare XL
espátula rectangular XL



ref.	cms.		Bar Code
738450	32x12	6/48	8411922439922

PALETA RECTANGULAR

rectangular spatula
spatule rectangulaire
spatula rettangolare
espátula rectangular



ref.	cms.		Bar Code
738400	25x7	6/96	8411922093056

RASQUETA TRIANGULAR

triangular scraper
racloir triangulaire
raschietto triangolare
raspador triangular



ref.	cms.		Bar Code
738300	25x10	6/144	8411922092950

PALETA TRIANGULAR

triangular spatula
spatule triangulaire
spatula triangolare
espátula triangula



ref.	cms.		Bar Code
738500	25x6	6/144	8411922093155

RASQUETA

scraper
raclette
raschietto
raspador



ref.	cms.		Bar Code
738100	16x12,5	6/72	8411922092240

PALA SERVIR TARTAS

cake server
pelle à tarte
pá para servir bolo

INOX /
S. STEEL



ref.	cms.		Bar Code
761500	25	6/144	8411922621877

COMPROBADOR DE TARTAS

cake tester
testeur de cuisson pour gateaux
injector de bolos



ref.	Cms.		Bar Code
778000	16	6/48	8411922080551

ESPÁTULA ACODADA

angled spatula
spatule coudée
gebogener spatel
espátula curva



ref.	Cms		Bar Code
737910E	10	6/96	8411922448689
737915E	15	6/96	8411922448696
737920E	20	6/96	8411922448702
737925E	25	6/72	8411922448719
737930E	30	6/72	8411922448726

ESPÁTULA RECTA

straight spatula
spatule droite
gerader spatel
espátula reta



ref.	Cms		Bar Code
737810E	10	6/96	8411922448634
737815E	15	6/96	8411922448641
737820E	20	6/96	8411922448658
737825E	25	6/72	8411922448665
737830E	30	6/72	8411922448672

SET 3 ESPATULAS MINI

set of 3 mini-spatulas
set 3 spatules mini
set 3 mini-spatel
conjunto 3 espátulas mini



ref.	Cms		Bar Code
738000E	10	6/72	8411922448733

RASQUETA

scraper
raclette
schaber
raspador



ref.	Cms		Bar Code
738100E	16x12,5	6/72	8411922448740

PALETA RECTANGULAR

rectangular spatula
spatule rectangulaire
rechteckiger spatel
espátula rectangular



ref.	Cms		Bar Code
738400E	29,5x7,5	6/72	8411922448764

PALETA RECTANGULAR XL

rectangular spatula xl
spatule rectangulaire xl
rechteckiger spatel xl
espátula rectangular xl



ref.	Cms		Bar Code
738450E	32x14	6/72	8411922448771

ESPÁTULA TRIANGULAR

triangular spatula
spatule triangulaire
dreieckiger spatel
espátula triangular



ref.	Cms		Bar Code
738500E	26,5x6	6/96	8411922448788

RASQUETA TRIANGULAR

triangular scraper
racloir triangulaire
dreieckiger schaber
raspador triangular



ref.	Cms		Bar Code
738300E	25x10	6/72	8411922448757

RASQUETA TRIANGULAR ECOPROF

triangular scraper
racloir triangulaire
dreieckiger schaber
raspador triangular

NEW



ref.	Cms		Bar Code
687215E	15x23,5	6	8411922459616

RASQUETA TRIANGULAR

triangular scraper
racloir triangulaire
dreieckiger schaber
raspador triangular

MANGO DE MADERA WOODEN HANDLE

NEW



ref.	Cms		Bar Code
687215M	15x21	6	8411922459630

SET 2 ESPÁTULAS MINI / REBAÑABOTES (espátula + cuchara)

set 2 mini-spatulas / spoon scraper (spatula + spoon)
set 2 spatules mini / lèche-plat (spatule+cuilère)
set 2 mini spatole / raschia-vasetti (spatola + cucchiaio)
set 2 espátulas mini / salazar (espátula+colher)

SILICONE

PLASTIC



ref.	Cms		Bar Code
748800	23	6/72	8411922438604

ESPÁTULA SILICONA con mango Inox 18% (display)

silicone scraper with s/s 18% handle (display)
spatule en silicone avec manche inox 18% (display)
espátula de silicone com cabo inox 18% (display)

SILICONE

INOX / S. STEEL



ref.	cms.		Bar Code
763900	30	6/144	8411922203110

PINCEL SILICONA MANGO PLÁSTICO

silicone brush, plastic handle
pinceau en silicone avec manche en plastique
pincel silicona com cabo plástico



ref.	cms.	📦	Bar Code
751800	24	6/24	8411922071139

SILICONE

PLASTIC

ESPÁTULA SILICONA GRANDE MANGO PLÁSTICO

silicone large spatule, plastic handle
spatule grand modèle avec manche en plastique
espátula de silicona grande com cabo plástico



ref.	cms.	📦	Bar Code
752550	25,3	6/24	8411922071153

ESPÁTULA SILICONA PROFESSIONAL

silicone scraper professional
spatule en silicone professional
silikonspatel professional
espátula silicona professional

SILICONE

LFGB



ref.	cms.	📦	Bar Code
702225	25	12/72	8411922451030
702236	36	12/72	8411922451047
702241	41	12/72	8411922451054

ESPÁTULA SILICONA mango Inox 18/10 profesional

spatula with s/s 18/10 wire handle silicon
spatule avec manche inox 18/10 silicone
espátula de borracha, cabo inox 18/10

max. 260°C

SILICONE

INOX / S. STEEL

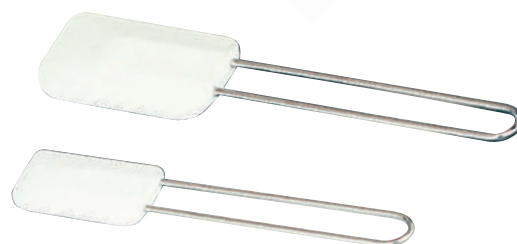

ref.	cms.	📦	Bar Code
702026	26	12/288	8411922618266
702032	32	12/144	8411922618327
702036	36	6/36	8411922448917

ESPÁTULA PLÁSTICO (blister)

scraper, plastic
spatule plastique
espátula plástico



ref.	H.	📦	Bar Code
756000	25	12/432	8411922600179

ESPÁTULA REPOSTERÍA NYLON

nylon cake server
spatule à pâtisserie nylon
espátula de pasteleria nylon

NYLON



ref.	H.	📦	Bar Code
758000	31	12/144	8411922600353

PINCEL REPOSTERÍA PLÁSTICO (blister)

pastry brush, plastic
pinceau à pâtisserie plastique
pincel pasteleiro plástico



ref.	cms.	📦	Bar Code
757100	21	6/144	8411922600261

PINCEL REPOSTERÍA

Pastry brush
Pinceau à pâtisserie
Backpinsel
Pincel pasteleiro

NYLON

PLASTIC



profesional
professional

ref.	Cms	H	📦	Bar Code
685602	2,5	23	6/480	8411922458541
685605	5,0	23	6/384	8411922458558
685607	7,5	23	6/288	8411922458565

SET ESPÁTULA + DECORADOR plástico

bowl scraper + cake decorator set, plastic set
ensemble de spatule + peigne à décorer plastique
jogo espátula + pente decorador plástico

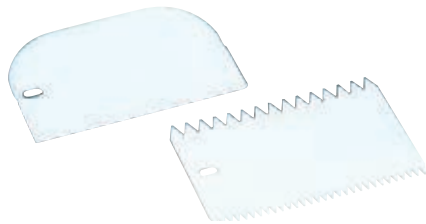

ref.	H.	📦	Bar Code
761100	15	12/360	8411922621839

CORTADOR DE MASAS / MEDIDOR DE SPAGUETI

dogh cutter + spaguetti measurer
décoyeurs + mesure à spaguetti
coppa-pasta + misura-spaghetti
corta-massas + medidiro para sparguette



ref.	cms.	📦	Bar Code
796500	15x12	12/12/144	8411922093803

RASQUETA CORTAMASAS PROFESIONAL RECTA

Professional straight dough cutter
Coupe-pâte professionnel droit
Gewerblicher teigschneider gerade
Raspador / corta-massas professional reto



PLASTIC

recta / straight

ref.	cms.	H	📦	Bar Code
686000	11.5	10,5	6	8411922459067

RASQUETA CORTAMASAS PROFESIONAL CURVA

Professional curved dough cutter
Coupe-pâte professionnel courbé
Gewerblicher teigschneider gewölbt
Raspador / corta-massas professional curvo



PLASTIC

curva / curved

ref.	cms.	H	📦	Bar Code
686010	11.5	10,5	6	8411922459074

SET 4 CUCHARAS DE MEDIDAS

set 4 measuring spoons
lot 4 cuillères à mesurer
set 4 cucchiari misuratori
jogo 4 colheres medidoras

INOX / S. STEEL

PP



1, 1/2 tsp
1, 1/2 Tbsp

ref.	cms.	📦	Bar Code
736800	14x4,5	6/288	8411922091809

SET 4 CAZOS DE MEDIDAS

set 4 measuring saucerpan
lot 4 casseroles à mesurer
set 4 misurini
jogo 4 caçarolas medidoras

INOX / S. STEEL

PP



1, 1/2, 1/3, 1/4 CUP

ref.	cms.	📦	Bar Code
736900	19x8,5	6/120	8411922091816

SET 4 CAZOS DE MEDIDAS

set 4 measuring saucerpan
lot 4 casseroles à mesurer
maß pfännchen set
jogo 4 caçarolas medidoras

INOX / S. STEEL



59 - 79 - 118 - 236 ML
1/4 - 1/3 - 1/2 - 1 CUP

ref.	∅	📦	Bar Code
701910	5-6-7-8,5	6/48	8411922449556

CUCHARAS MEDIDAS (4 PIEZAS)

measuring spoons (4 p)
cuillère à mesurer (4 p)
colher medidor (4 p)

INOX / S. STEEL



ref.	📦	Bar Code
701400	6/12	8411922612004

TAMIZADOR (malla inox)

sieve
tamis
peneira



ref.	cms.		Bar Code
704216	16	4/48	8411922069891
704220	20	4/48	8411922069907
704225	25	4/48	8411922069914

TAMIZADOR

flour sifter
tamis
peneira



ref.	cms.		Bar Code
761000	8,5	6/96	8411922621822

TAMIZADOR BISTROT

flour sifter
tamis
peneira



ref.	cms.		Bar Code
761003	10	6/60	8411922080117

ESPOLVOREADOR DE MALLA

mesh shaker
boîte à saupoudrer maille
polvilhador malha



ref.	cms.	H.		Bar Code
742200	7	10	6/6	8411922435405

ESPOLVOREADOR

shaker
boîte à saupoudrer
polvilhador



ref.	lts.		Bar Code
757400	0,25	6/96	8411922600285

JARRA MEDIDAS, PLÁSTICO

measuring cup, plastic
verre mesurer, plastique
copo medidor, plástico



ref.	lts.		Bar Code
765200	0,6	12/48	8411922206364

MEDIDOR / RACIONADOR MÚLTIPLE

multiple measurer / portioner
 mesureur / doseur multiple
 messbecher, mehrfach skaliert/skalierbar
 medidor / racionador múltiplo

PERSONALIZABLE CUSTOMIZABLE



libli design

ref.	Lts.	Ø	H.	📦	Bar Code
787410	0,500	10	14,5	1/6/24	8411922449228

EL SET INCLUYE · THE SET INCLUDES
 LE SET INCLUT · SET ENTHÄLT · O KIT INCLUI



- (E) Medidas tradicionales (Volumen, Harina, Azúcar, Arroz)
- (UK) Traditional measurements (Volume, Flour, Sugar, Rice)
- (F) Mesures traditionnelles (Volume, Farine, Sucre, Riz)
- (D) Herkömmliche Mengenangaben (Volumen, Mehl, Zucker, Reis)
- (P) Medidas tradicionais (Volume, Farinha, Açúcar, Arroz)

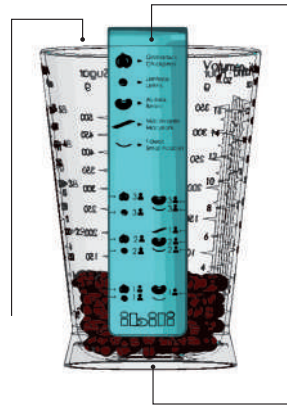

- (E) Raciones recomendadas: Garbanzos, Lentejas, Alubias, Macarrones, Fideos.
- (UK) Recommended servings: Garbanzo beans, Lentils, Beans, Macaroni, Noodles.
- (F) Rations recommandées : Pois chiche, Lentilles, Haricots blancs, Nouilles, Vermicelles.
- (D) Empfohlene Mengen: Erbsen, Linsen, Bohnen, Makkaroni, Nudeln.
- (P) Rações recomendadas: Grão-de-bico, Lentilhas, Feijão, Macarrão, Massa para sopa.
- (E) Medidor de espaguetis / 1 cucharada.
- (UK) Spaghetti mesurer / 1 TBSP.

PERSONALIZA TU REGLA · CUSTOMIZE YOUR RULER · PERSONNALISEZ VOTRE RÈGLE EIGENE FÜLLSKALA · PERSONLIZE A SUA RÉGUA



- (E) Ejemplos de regla personalizada:
 - Caldo para el guiso.
 - Nata y jamón para la pasta carbonara.
 - Cacao, nueces, moras y aceite para el bizcocho.
- (UK) Examples of customized rulers:
 - Broth for stew.
 - Cream and ham for pasta carbonara.
 - Cocoa, walnuts, berries, and oil for cake.
- (F) Exemples de règle personnalisée :
 - Bouillon pour le ragoût.
 - Crème fraîche et bacon pour les pâtes à la carbonara.
 - Cacao, noix, mûres et huile pour le gâteau.
- (D) Beispiele für eigene Füllskalen:
 - Brühe für Schmorgerichte.
 - Sahne und Schinken für Pasta a la Carbonara.
 - Kakao, Nüsse, Beeren und Öl für Kuchen.
- (P) Exemplos de régua personalizada:
 - Caldo para guisados.
 - Nata e presunto para massa carbonara.
 - Cacao, nozes, amoras e azeite para bolos.



BLUEBERRY

max. 220°C

SILICONE

LFGB

ESPÁTULA

spatula
spatule
kelle
espátula



ref.	Cms		Bar Code
799210	27	6/72	8411922453454

CUCHARA

spoon
cuillère
löffel
colher



ref.	Cms		Bar Code
799220	27,5	6/72	8411922453461

ESPÁTULA-CUCHARA

spatula-spoon
spatule-cuillère
kelle-löffel
espátula-colher



ref.	Cms		Bar Code
799230	27	6/72	8411922453478

PINCEL

brush
pinceau
pinsel
pincel



ref.	Cms		Bar Code
799240	26	6/72	8411922453485

BATIDOR MECÁNICO

Hand push whisk
Fouet mécanique
Handrührgerät
Batedeira mecânica

INOX /
S. STEEL



semi-automatic



ref.	cms.		Bar Code
786725	25	6/72	8411922457896
786730	30	6/72	8411922457902

ESPÁTULA / CUCHARA

spatule / spoon
 spatule / cuillère
 spatola / cucchiaio
 espatula/ colher

INOX /
S. STEEL

SILICONE



12 A
+
8 B
20 un.

ref.	cms.		Bar Code
742601	26/28	20 (12+8)	8411922435559

PINCEL / PINZA

brush / tong
 pinceau / pinçe
 penello / pinza
 pincel / pinça

INOX /
S. STEEL

SILICONE

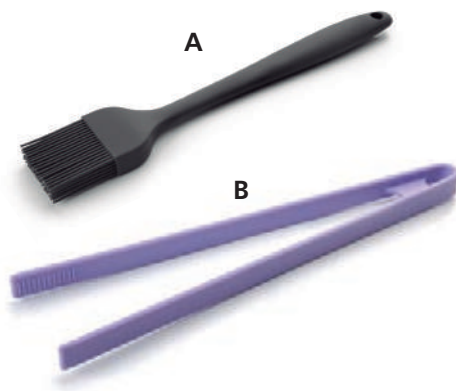

10 A
+
10 B
20 un.

ref.	cms.		Bar Code
742600	25/29	20 (10+10)	8411922435542

PINCEL / ESPÁTULA

brush / spatule
 pinceau / spatule
 penello / spatola
 pincel / espátula

INOX /
S. STEEL

SILICONE

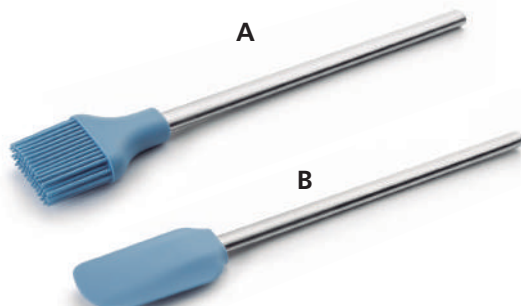

12 A
+
12 B
24 un.

ref.	cms.		Bar Code
742700	32	24 (12+12)	8411922435566

CUCHARA DE SILICONA

silicone spoon
cuillère en silicone
cucchiaio in silicone
colher silicona



ref.	cms.		Bar Code
732400	30	12/48	8411922086553

ESPÁTULA DE SILICONA

silicone spatule
spatule en silicone
spatola in silicone
espátula silicona

SILICONE FIBERGLASS

max. 180°C



ref.	cms.		Bar Code
732500	30	12/48	8411922086560

PINCEL DE SILICONA

silicone brush
pinceau en silicone
penello in silicone
pincel silicona



ref.	cms.		Bar Code
732600	30	12/48	8411922086577

ESPÁTULA REPOSTERÍA SILICONA

silicone bakery spatula
spatule pâtisserie en silicone
spatola pasticceria in silicone
espátula pasteleria silicona



ref.	cms.		Bar Code
735300	30x5	12/96	8411922089011

PINZA SILICONA

silicone tong
pince en silicone
pinza in silicone
pinça en silicona



ref.	cms.		Bar Code
736300	30	12/36	8411922090369

BATIDOR SILICONA CON MANGO INOX

silicone whisk s/steel handle
fouet silicone avec manche inox
frusta in silicone con manico in acciaio
batedor silicona com cabo inox



ref.	cms.		Bar Code
786800	25	12	8411922087574

BATIDOR CLASS MINI

whisk class mini
batteur class mini
batedor class mini

INOX /
S. STEEL



ref.	cms.		Bar Code
750515	15	6/72	8411922068887

BATIDOR MINI

whisk mini
batteur mini
batedor mini

INOX /
S. STEEL



ref.	cms.		Bar Code
750415	15	6/288	8411922068870

BATIDOR 12 VARILLAS

whisk 12 wires
fouet 12 fils
batedor 12 fios

INOX /
S. STEEL
18/10



ref.	cms.		Bar Code
750225	25	6/144	8411922083217
750230	30	6/96	8411922083224
750235	35	6/96	8411922083231
750240	40	6/120	8411922083248

BATIDOR MANGO TERMOSELLADO

whisk with heat-sealed handle
fouet manche thermoscellé
schneebeesen heissversiegelter griff
batedor com pega termoselada

ABS

INOX /
S. STEEL
18/10

loli design



PROFESIONAL / PROFESSIONAL



Fiberglass

termosellado
heat-sealed handle

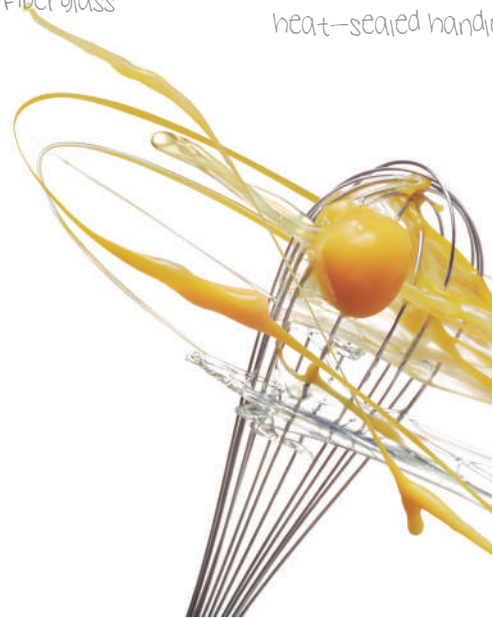

ref.	cms.		Bar Code
680125	25	6/24	8411922448832
680130	30	6/24	8411922448849
680135	35	6/24	8411922448856
680140	40	6/24	8411922448863

- A 6 varillas/wires
- B 6 varillas/wires
- C 9 varillas/wires
- D 9 varillas/wires

SEPARADOR DE YEMAS MÚLTIPLE

multiple egg yolk separator
séparateur de jaunes d'oeufs multiple
mehrfacher eigelbtrenner
separador de gemas múltiplo

ABS

ibili design

100% ajustable

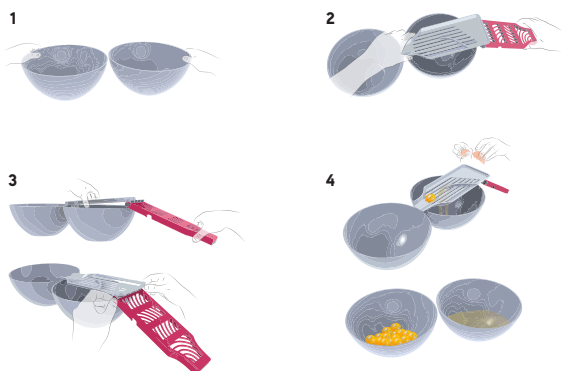
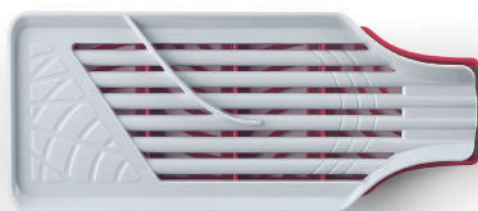

ref.	cms.	📦	Bar Code
682300	12x29	1/6	8411922455939

SEPARADOR DE YEMAS

yolk separator
séparateur de jaunes d'oeufs
separatore di tuorli
separador de gemas

PLASTIC



ref.	Ø	📦	Bar Code
739300	10x7x4	6/144	8411922433531

SEPARADOR DE YEMAS INOX

yolk separator
séparateur à oeuf
separador gema ovos

INOX /
S. STEEL
18/10



ref.	cms.	📦	Bar Code
709500	17	6/6	8411922076929

CORTADOR CROSTATA ROMBO

Diamond crostata cutter
Plaque découpoir dessus de tarte
Crostata-schneider raute
Cortador para tartes losangos

PLASTIC

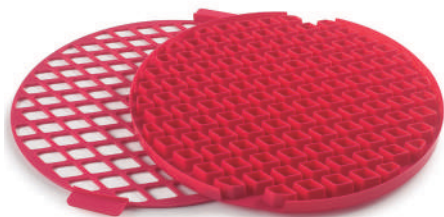

ref.	Cms.		Bar Code
686100	30	6/12	8411922459104

CORTADOR CROSTATA ARABESQUE

Arabesque crostata cutter
Plaque découpoir dessus de tarte motifs arabesques
Crostata-schneider arabische art
Cortador para tartes árabe

PLASTIC

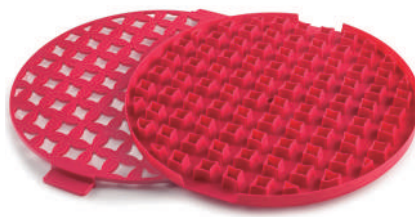

ref.	Cms.		Bar Code
686110	30	6/12	8411922459111

PALA-BASE PARA PIZZAS Y TARTAS-RECTANGULAR

server-base for pizza and cakes-rectangular
pelle à gâteaux et pizzas-rectangulaire
pá-baseie pára pizzas e tartas rectangular

INOX /
S.STEEL



ref.	cms.		Bar Code
781700	37x25	1/6	8411922082531

PALA-BASE PARA PIZZAS Y TARTAS-REDONDA

server-base for pizza and cakes-round
pelle à gâteaux et pizzas-ronde
pá-baseie pára pizzas e tartas redonda

INOX /
S.STEEL



ref.	cms.		Bar Code
725200	25	6/24	8411922082203

REJILLA ENFRIATARTAS REDONDA

cake cooling rack-round
grille ronde à gâteaux
greilha enfiadora de bolos redonda

INOX /
S.STEEL

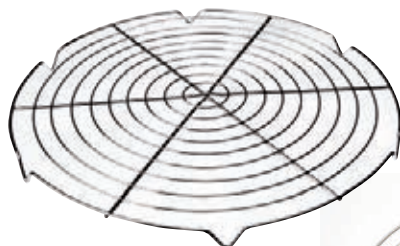

ref.	cms.		Bar Code
780730	30	6/60	8411922082418

REJILLA ENFRIATARTAS RECTANGULAR

cake cooling rack-rectangular
grille rectangulaire à gâteaux
greilha enfiadora de bolos rectangular

INOX /
S.STEEL

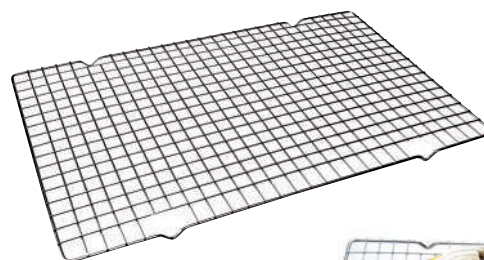

ref.	cms.		Bar Code
780825	40x25	6/6	8411922082425

RODILLO PUNTEADOR

roller docker
rouleau pique vite
rolo de massa tacejador



ref.	Cms		Bar Code
771700	12	6/72	8411922077964

RODILLO ROMBOS

lattice cutting roller
rouleau à losange
rolo de massa cortador grelha



ref.	Cms		Bar Code
771800	12	6/72	8411922077971

PINZA PARA MASAS

crimper
pinze à chiquer la pâte
pinça para massas

ibili design



INOX /
S. STEEL

ref.	Cms		Bar Code
770500	14	6/6	8411922454765

BASE GIRATORIA ALTA

high rotating base
plateau tournant haute
Hoher Drehfuß
base giratória alta

ibili design



PLASTIC



ref.	Ø	H		Bar Code
789301	31	12,5	1/6	8411922090000
789310	35	13	1/6	8411922458572

BASE GIRATORIA BAJA

low rotating base
plateau tournant basse
base girevole bassa
base giratória baixa

PLASTIC



ref.	Ø	H		Bar Code
789300	31	5	6/6	8411922089998

SOPORTE GIRATORIO (CRISTAL + INOX) (CAJA INDIV.)

revolving cake stand (glass + s/steel) (gift box)
plateau tournant (verre + inox) (boîte indiv.)
prato giratório (vidro + inóx) (caixa indiv.)

GLASS

INOX /
S. STEEL



ref.	cms.	H		Bar Code
717130	30	7	1/6	8411922077599

Baking cups

CAPSULAS REPOSTERÍA

baking cups
capsules à pâtisserie
pirottini
cápsulas doceria (100 un)

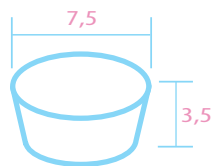

max. 220°C   30 min.

special
cupcake

IMPERMEABLE A LA GRASA
greaseproof impermeable graisses
impermeabile al grasso
impermeável à gordura



100 ud.



ref.	cms.	H		Bar Code
735900	7,5	4	12/72	8411922090147

50+50 ud.



ref.	cms.	H		Bar Code
735901	7,5	4	12/72	8411922090154

50+50 ud.



ref.	cms.	H		Bar Code
735903	7,5	4	12/72	8411922090178

50+50 ud.



ref.	cms.	H		Bar Code
735904	7,5	4	12/72	8411922090185

50+50 ud.



ref.	cms.	H		Bar Code
735907	7,5	4	12/72	8411922090215

50+50 ud.



ref.	cms.	H		Bar Code
735908	7,5	4	12/72	8411922090222

50+50 ud.



ref.	cms.	H		Bar Code
735909	7,5	4	12/72	8411922090239

50+50 ud.



ref.	cms.	H		Bar Code
735910	7,5	4	12/72	8411922090246

CÁPSULAS REPOSTERÍA PRINCESA

baking cups princess
capsules à pâtisserie princesse
pirottini principessa
cápsulas doceria princesa



CÁPSULAS REPOSTERÍA BABY

baking cups baby
capsules à pâtisserie baby
pirottini baby
cápsulas doceria baby



50+50 ud.



ref.	cms	H		Bar Code
735913	7,5	4	12/72	8411922433593

50+50 ud.



ref.	cms	H		Bar Code
735914	7,5	4	12/72	8411922433609

SET 100 CÁPSULAS NAVIDAD

set 100 baking cups christmas
set 100 capsules à pâtisserie Noël
set 100 pirottini natal
set 100 cápsulas natal

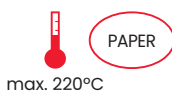

SET 100 CÁPSULAS PASCUA

set 100 baking cups easter
set 100 capsules à pâtisserie pâques
set 100 pirottini pascua
set 100 cápsulas pascua



IMPERMEABLE A LA GRASA
greaseproof impermeable graisses
impermeabile al grasso
impermeável à gordura



ref.	cms.		Bar Code
735911	7,5	12/72	8411922091991



ref.	cms.		Bar Code
735912	7,5	12/72	8411922092004

50+50 ud.

max. 220°C



ref.	cms.	H	📦	Bar Code
735905	7,5	4	12/72	8411922090192

CÁPSULAS REPOSTERÍA MINI

baking cups mini
capsules à pâtisserie mini
pirottini mini
cápsulas doceria mini



ref.	cms.	H	📦	Bar Code
737200	4,5	2,5	12/144	8411922092042

SET 96 CÁPSULAS CUPCAKE Y 24 BANDERITAS ATAUD

set 96 cupcake cases and 24 flags coffin
jeu 96 moules et 24 drapeaux pour cupcakes cercueil
set 96 pirottini e 24 badieras bara
set 96 capsulas cupcake y 24 bandeiras caixaõ



PAPER



ref.	∅	📦	Bar Code
737000	7,5	12/48	8411922092028

CÁPSULA MADALENA PAPEL

baking cups, paper
barquettes à pâtisserie, papier
cápsula madalena, papel

75 ud.



ref.	cms.	📦	Bar Code
701600	6,5	12/240	8411922614008

CÁPSULA BOMBÓN PAPEL

candy cases
moules pralinés
cápsula bomboneira

100 ud.



ref.	cms.	📦	Bar Code
764200	2,5	12/144	8411922203806

CÁPSULAS BOMBÓN

candy cases
moules pralinés
pirottini per praline
cápsula bomboneira

36 ud.

METALLIC



ref.	cms.	H	📦	Bar Code
737700	3	1,5	12/144	8411922092134

CÁPSULA BOMBÓN PAPEL

candy cases
moules pralinés
cápsula bomboneira

48 ud.



ref.	cms.	📦	Bar Code
706600	4	12/240	8411922072846

CÁPSULAS BOMBÓN CORAZÓN

candy cases heart
moules pralinés coeur
pirottini per praline cuore
cápsula bomboneira coração

36 ud. METALLIC



ref.	cms.	H		Bar Code
737600	3	1,5	12/144	8411922092127

CÁPSULAS REDONDAS-COLORES

round-colors baking cups
capsules rond-couleurs
pirottini tondo-colori
cápsulas redondo-cores

10+10 ud. PAPER BOARD



ref.	cms.	H		Bar Code
737401	6	5,5	6/36	8411922092073

CÁPSULAS RECTANGULARES - LUNARES

rectangular baking cups
capsules rectangulaires
pirottini rettangolari
cápsulas rectangulares

12 ud.



ref.	cms.	H		Bar Code
737450	9,5	3,2	12/144	8411922092097

SOPORTE PARA CUP CAKE

cupcake support
support pour cupcakes
supporto per cupcake
suporte para cupcakes

CARTÓN DESECHABLE

disposable cardboard
cartón jetable
cartone monouso
cartão descartável

10-12 cupcakes



ref.	cms.	H		Bar Code
736100	25	26	12/48	8411922090284

SOPORTE PARA CUP CAKE

cupcake support
support pour cupcakes
supporto per cupcake
suporte para cupcakes

CARTÓN DESECHABLE

disposable cardboard
cartón jetable
cartone monouso
cartão descartável

10-12 cupcakes



ref.	cms.	H		Bar Code
736101	34,5	44	12/36	8411922090291

SOPORTE PARA CAKEPOPS Y CUPCAKES

cakepop-cupcake support
 support pour cakepops-cupcakes
 supporto per cakepops-cupcakes
 suporte para cakepops-cupcakes



48 palitos
 sticks
 batons
 bastoncini
 palitos

PLASTIC



ref.	cms.	H		Bar Code
827600	30	24	1/6	8411922091700

ENVOLTORIO TELARAÑA

spiderweb wrapper
 caissette toile d'araignée
 cestino con decorazione a ragnatela
 invólucro teia de aranha



PAPER

10 ud.

ref.	Ø		Bar Code
736003	21x5	12/72	8411922092011

ENVOLTORIO PARA CUPCAKE

cupcake wrapper
 emballage de cupcakes
 involucro per cupcake
 invólucro de cupcakes



ref.	Ø		Bar Code
736001	5+8	12/72	84119220890260

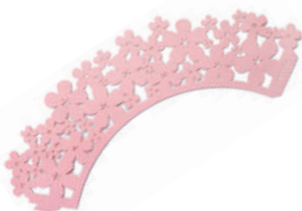

ref.	Ø		Bar Code
736000	5+8	12/72	8411922090253

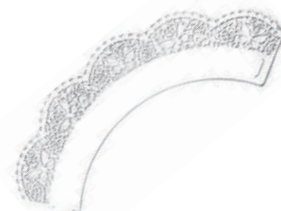

ref.	Ø		Bar Code
736002	5+8	12/72	8411922090277

10 ud.



Blondas

Desechables
Disposables
Jetables
Descartavéis

BLONDA REDONDA

round doilies
napperons ronds
naperons redondos

10 ud.



ref.	cms.		Bar Code
701712	12	12/96	8411922072815
701726	26	12/96	8411922085686
701734	34	12/96	8411922085709

BLONDA RECTANGULAR

rectangular doilies
napperons rectangulaires
naperons rectangulares

10 ud.



ref.	cms.		Bar Code
701830	30x39	12/96	8411922085723

BANDEJA REDONDA

round plate
plat rond
bandeja redonda

5 ud.



ref.	cms.		Bar Code
728923	23	12/24	8411922085747
728927	27	12/24	8411922085754
728932	32	12/24	8411922085761

BANDEJA RECTANGULAR

square plate
plat rectangulaire
bandeja rectangular

5 ud.



ref.	cms.		Bar Code
729011	11x36	12/24	8411922085778
729021	21x28	12/24	8411922085785
729026	26x34	12/24	8411922085732
729029	29x38	12/24	8411922085808

5 BANDEJAS 32 cm. + 5 BLONDAS REDONDAS 34 cm.

5 plates 32 cm. + 5 rounds doilies 34 cm.

5 plats 32 cm. + 5 napperons ronds 34 cm.

5 bandejas 32 cm. + 5 naperons redondos 34 cm.



ref.	cms.		Bar Code
729500	32x34	12/24	8411922085815

5 BANDEJAS RECT. 34x26 cm. + 5 BLONDAS RECTANGULARES 30x39 cm.

5 plates 34x26 cm. + 5 rect. doilies 30x39 cm.

5 plats 34x26 cm. + 5 napperons rectangulaires 30x39 cm.

5 bandejas 34x26 cm. + 5 naperons rectangulares 30x39 cm.



ref.	cms.		Bar Code
729501	34X26 / 30X39	12/24	8411922085822

3 BANDEJAS RECT. 34x26 + 3 BLONDAS RECTANGULARES 30x39 cm.

3 plates 34x26 cm. + 3 rect. doilies 30x39
 3 plats 34x26 cm. + napperons rectangulaires 30x39 cm.
 3 vassoietti cm. + 3 centrini rettangolari cm. 30x39.
 3 bandejas 34x26 cm. + naperons rectangulares 30x39 cm.

SILVER



ref.	cms.		Bar Code
729521	30x39+26x34	12/24	8411922089080

3 BANDEJAS RECT. 34x26 + 3 BLONDAS RECTANGULARES 30x39 cm.

3 plates 34x26 cm. + 3 rect. doilies 30x39
 3 plats 34x26 cm. + napperons rectangulaires 30x39 cm.
 3 vassoietti cm. + 3 centrini rettangolari cm. 30x39.
 3 bandejas 34x26 cm. + naperons rectangulares 30x39 cm.

GOLD



ref.	cms.		Bar Code
729511	30x39+26x34	12/24	8411922089066

3 BANDEJAS 32 cm. + 3 BLONDAS REDONDAS 34 cm.

3 plates 32 cm. + 3 rounds doilies 34 cm.
 3 plats 32 cm. + 3 napperons ronds 34 cm.
 3 vassoi cm. 32 + centrini tondi 34
 3 bandejas 32 cm. + 3 naperons redondos 34 cm.

GOLD



ref.	cms.		Bar Code
729510	34+32	12/24	8411922089059

3 BANDEJAS 32 cm. + 26x31. + 3 BLONDAS REDONDAS 34 cm.

3 plates 32 cm. + 3 rounds doilies 34 cm.
 3 plats 32 cm. + 3 napperons ronds 34 cm.
 3 vassoi cm. 32 + centrini tondi 34
 3 bandejas 32 cm. + 3 naperons redondos 34 cm.

SILVER



ref.	cms.		Bar Code
729520	34x32	12/24	8411922089073

3 BANDEJAS + 3 BLONDAS PLUM CAKE

3 plates + 3 doilies plum cake
 3 plats + 3 napperons plum cake
 3 vassoietti + 3 centrini plum cake
 3 bandejas + 3 naperons plum cake



ref.	cms.		Bar Code
729502	11X36 - 14X36	12/24	8411922091588

CAJA PARA COOKIES-BOMBONES CASITA

little house box for cookies-sweets
 boîte pour cookies-chocolats maisonnette
 contenitore per biscotti-caramelle a forma di casetta
 caixa em forma de casinha para cookies-bombons

4 ud.

PAPER BOARD



ref.	cms.		Bar Code
739500	3	12/72	8411922433616

CAJA PARA 4 CUPCAKES

box for 4 cupcakes
boîte pour 4 cupcakes
teglia per 4 cupcakes
caixa para 4 cupcakes

2 ud.

PAPER BOARD



ref.	cms.	H		Bar Code
737504	16X16	7,5	12/144	8411922092103

CAPSULA BOMBON

candy case
moule praliné
cápsula bomboneira

100 ud.



ref.	cms.	H.		Bar Code
729204	4	2	12/48	8411922085846

CAPSULA MADALENA REDONDA

round baking cup
barquette à pâtisserie rond
capsula madalena redonda

50 ud.



ref.	cms.	H.		Bar Code
729307	7	3,5	12/48	8411922085853
729308	8	4,5	12/48	8411922085860

CÁPSULAS MUFFIN

muffin baking cups
capsules à pâtisserie biscuits
pirottini per para muffin
cápsulas para bolinhos

50 ud.

max. 220°C



ref.	cms.	H		Bar Code
738200	7,5	4	6/72	8411922092301



SET 6 MOLDES MADALENA SILICONA (caja PVC)

set 6 baking cups (pvc box)
lot 6 moules à madeleines (boîte pvc)
jogo 6 moldes madalena (caixa pvc)



ref.	cms.		Bar Code
752400	7x3,5	6/96	8411922071269

SET 6 CÁPSULAS MINI

set 6 baking cups mini
set 6 capsules à pâtisserie mini
set 6 pirottini mini
set 6 cápsulas doceria mini

SILICONE



ref.	Ø	H		Bar Code
872400	5	2	6/92	8411922091922

SET 4 CÁPSULAS PARA CUPCAKE

set of 4 cupcake molds
set 4 capsules pour cupcake
set 4 stampi per cupcake
conjunto 4 cápsulas para cupcake



SILICONE

ref.	cms.	H.	📦	Bar Code
871406	6,5	3,8	6/24	8411922087918

VACIADOR CUPCAKES

cupcake corer
évideur de cupcakes
scavino svuota cupcake
esvaziador de cupcakes



PLASTIC



ref.	cms.	📦	Bar Code
735000	2,5x3,5	6/96	8411922088984

SET 6 MOLDES GELATINA (display)

set 6 jelly moulds (display)
lot 6 moules à gelée (display)
jogo 6 formas gelatina (display)

PLASTIC



ref.	cms.	H.	📦	Bar Code
756500	7,3	6,1	6/48	8411922209242

BOLAS PARA REPOSTERIA

balls for desserts
billes pour pâtisserie
bolas para pasteleria

CERAMIC



ref.	kg.	📦	Bar Code
728502	0,250	6/24	8411922085037

GUÍA CORTABIZCOCHOS EN CAPAS

layer cake slicing kit
guide coupe-gâteau en couches
torta a fette
guia corta-pão-de-ló em camadas

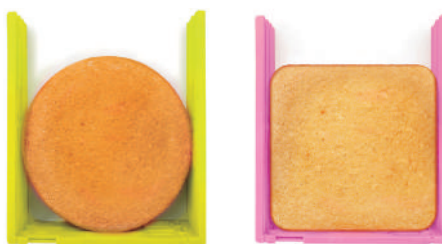

ABS

Para bizcochos redondos, cuadrados, etc.
For round, square cakes, etc.

ibili design

copyright

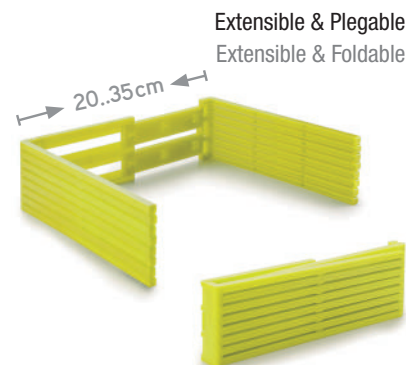

ref.	cms.	H.	📦	Bar Code
748700V	20..35	10	1	8411922438338
748700R	20..35	10	1	8411922438345

Green / Verde ①
Pink / Rosa ②

LIRA PARA TARTAS INOX 18/10

cake leveler
lyre à génoise
cortador de bolos

INOX /
S. STEEL
18/10

*HILO REPUESTO (10 u.)

spare wire (10 u.)
fil (10 u.)
fio (10 u.)

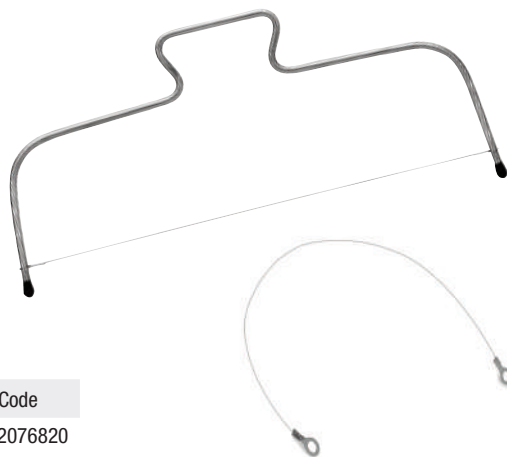

ref.	Cms.		Bar Code
708933	32	6/48	8411922076820
* 725033	32	1	8411922082906

GUÍA CORTABIZCOCHOS EN CAPAS L

layer cake slicing kit
guide coupe-gâteau en couches
torta a fette
guia corta-pão-de-ló em camadas

NEW



NOT ALL COUNTRIES
NO DISPONIBLE EN TODOS LOS PAISES

INOX /
S. STEEL



ref.	Cms.	H		Bar Code
731210	16-20	8	1/6	8411922459432

GUÍA CORTABIZCOCHOS EN CAPAS XL

layer cake slicing kit
guide coupe-gâteau en couches
torta a fette
guia corta-pão-de-ló em camadas

NOT ALL COUNTRIES
NO DISPONIBLE EN TODOS LOS PAISES

INOX /
S. STEEL



ref.	Cms.	H		Bar Code
731200	24-30	8,5	1/6	8411922086096

SET MARCADORES DE TARTAS/TORTILLAS

Set of cake and omelette markers
Ensemble de marque-parts pour gateaux ou tortillas
Marker-set für torten und tortillas
Conjunto de marcadores de tartes/tortilhas

PARA LAS DIVISIONES DE PORCIONES MÁS DIFÍCILES.
FOR MAKING THE MOST DIFFICULT PORTION DIVISIONS.

PLASTIC



ibili design





ref.	Ø.		Bar Code
684600	5	6/96	8411922457964

MARCADOR DE TARTAS EN PORCIONES

portion maker of pies and tarts
marqueur à gateaux en portions
porzionatore per torte
marcador de bolos em porções

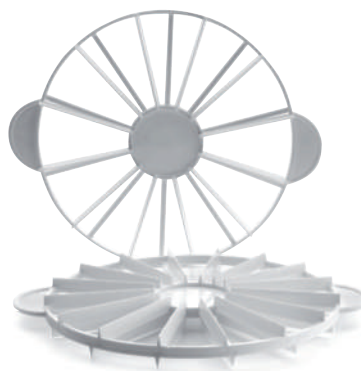
PLASTIC



ref.	cms.			Bar Code
732700	26	10+12	6/6	8411922086584
732800	26	14+16	6/6	8411922086591

Fondant



MOLDE CHOCOLATE LETRAS Y NÚMEROS

moulds for chocolate letters and numbers
moule à chocolat en forme de lettres et de chiffres
stampa per lettere e numeri di cioccolato
forma de chocolate com letras e números

SILICONE

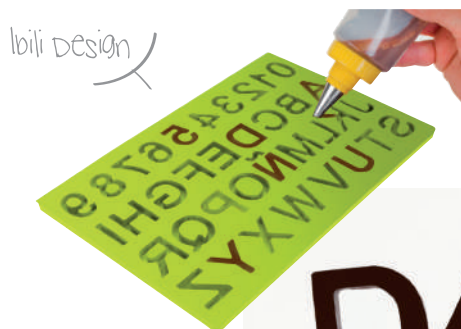

ref.	Cms.		Bar Code
871300	16x24	6/120	8411922086942

TAPETE DE REPOSTERÍA CON MEDIDAS

pastry mat with measurements
tapis à pâtisserie avec mesures
tappetino per pasticceria con misure
tapete de confeitaria com medidas

Ø 14+30

PLASTIC

Portions
8-10-12-14-16

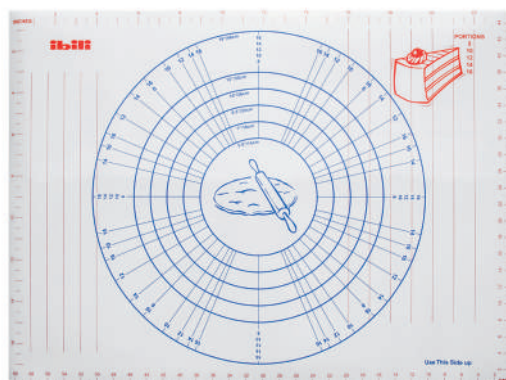

loli design



ref.	cms.		Bar Code
738600	61x45,5	1/6/48	8411922093254

RODILLO MILRAYAS

thousand stripes roller
rouleau milleraies
rullo millerighe
rolo mil listras

METHACRYLATE

ibili design



ref.	Cms.	H.	📦	Bar Code
788300	14	2,5	6/24	8411922088472

JUEGO 12 ESTECAS PARA MODELAR

modeling tool set 12 pieces
ensemble 12 outils pour fondant
jogo de 12 estecas para bolear

24 formas
models
modèles
formas



ref.	cms.	📦	Bar Code
752900	14	1/12	8411922084238

RODILLO NYLON

nylon roller
rouleau nylon
rullo nylon
rolo nylon



ref.	Cms.	H.	📦	Bar Code
788219	19	3	6/24	8411922088298
788223	23	2,5	6/72	8411922091885

ANILLAS NIVELADORAS PEQUEÑAS

leveling rings
anneaux de nivelage
dischi per livellare
anilhas niveladoras

SILICONE



Para rodillo 788223
For 788223 rolling pin

ref.	mm	📦	Bar Code
792050	1,6+3,20	6/72	8411922091878

TABLILLAS NIVELADORAS DE FONDANT (6 pc)

fondant icing level
planches à niveler
placche livellatrici il fondant
placas niveladoras de fondant

PLASTIC

	H: 8 mm x 2 pc
	H: 4 mm x 2 pc
	H: 2 mm x 2 pc

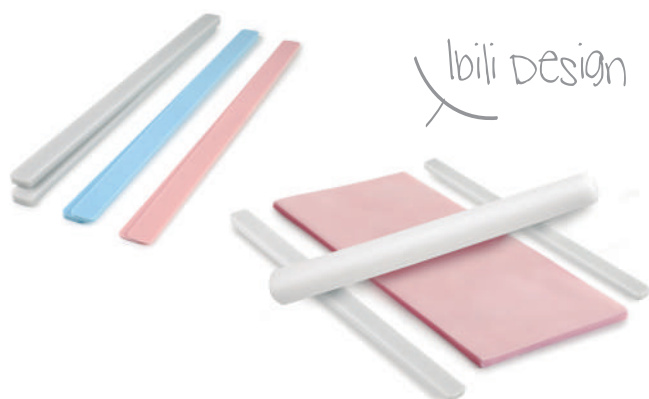

ibili design

ref.	Cms.	📦	Bar Code
787310	35	1/6	8411922454369

TABLILLAS NIVELADORAS DE FONDANT (6 pc)

fondant icing level
planches à niveler
placche livellatrici il fondant
placas niveladoras de fondant

PLASTIC

	H: 10 mm x 2 pc
	H: 5 mm x 2 pc
	H: 3 mm x 2 pc



ibili design

ref.	Cms.	📦	Bar Code
787300	35	1/6	8411922087741

Anodized aluminium



MOLDE REDONDO ALTO

round deep cake pan
moule rond profond
stampo rotondo alto
forma redonda alta

ref.	cms.	H	Lts	📦	Bar Code
815015	15	7,6	1,3	6/6	8411922089387
815025	25	7,6	3,8	6/6	8411922089400
815030	30	7,6	5,5	6/6	8411922089417



MOLDE REDONDO EXTRA ALTO

round extra deep cake pan
moule rond extra profond
stampo rotondo extra alto
forma redonda extra alta

ref.	cms.	H	Lts	📦	Bar Code
815110	10	10	0,8	6/6	8411922089431
815115	15	10	1,8	6/6	8411922089448
815120	20	10	3,2	6/6	8411922089455
815125	25	10	5	6/6	8411922089462
815130	30	10	7,3	6/6	8411922089479
815135	35	10	10	6/6	8411922089486



MOLDE CUADRADO EXTRA ALTO

square extra deep cake pan
moule carré extra profond
stampo quadrato extra alto
forma quadrada extra alta

ref.	cms.	H	Lts	📦	Bar Code
815212	12,5	10	1,6	6/6	8411922089493
815215	15	10	2,3	6/6	8411922089509
815220	20	10	4,1	6/6	8411922089516
815225	25	10	6,5	6/6	8411922089523
815230	30	10	9,3	6/6	8411922089530



MOLDE REDONDO EXTRA ALTO MÓVIL

round extra deep cake pan, loose bottom
moule rond extra profond amovible
extra hohe tragbare runde form
forma redonda extra alta, fondo solto

ref.	Cms	H	📦	Bar Code
815715	15	10	6	8411922449594
815720	20	10	6	8411922449600
815725	25	10	6	8411922449617
815730	30	10	6	8411922452112



Fondo móvil
Loose bottom



MOLDE DESMONTABLE

springform
moule démontable
stampo removibile
forma desmontável

max. 230°C



ref.	Cms	H		Bar Code
815320	20	10	6/6	8411922438628
815326	26	10	6/6	8411922438642

MOLDE CAKE

cake mould
moule à cake
stampo plumcake
forma de bolo inglês



ref.	Cms.	H		Bar Code
815425	25x10	7,5	6/6	8411922440065

MOLDE PAN

loaf pan
moule à pain anglais
stampo per pane inglese
forma de pão inglês



ref.	Cms	H		Bar Code
815520	19x10,5	11,5	3/6	8411922440072

MOLDE PAN INGLÉS

loaf pan
moule à pan anglais
brotbackform
forma de pão inglês

XL

 ANODIZED ALUMINIUM



ref.	Cms	H		Bar Code
815634	34,5x12	12,5	3/6	8411922441895

BASES PARA FONDANT

base for fondant
base pour fondant
base per fondant
base para fondant

 H: 12 mm

 CORRUGATED PAPER



ref.	Cms.		Bar Code
787020	20	6/24	8411922087604
787025	25	6/24	8411922087611
787030	30	6/24	8411922087628
787035	35	6/24	8411922087635
787040	40	6/24	8411922087642
787045	45	6/24	8411922087659

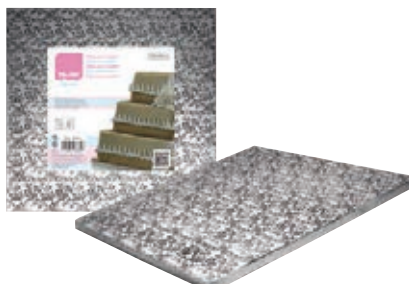

ref.	Cms.		Bar Code
787125	25x25	6/24	8411922087673
787130	30x30	6/24	8411922087680
787135	35x35	6/24	8411922087697
787140	40x40	6/24	8411922087703
787145	45x45	6/24	8411922087710



ref.	Cms.		Bar Code
787225	25x35	6/24	8411922087727
787230	30x40	6/24	8411922087734

SET 3 CORTADORES CON EXPULSOR BLOSSOM

set of 3 cutters with ejector blossom
 set 3 emporta-pièces avec pousoir blossom
 set 3 tagliapasta espulsioni blossom
 jogo 3 corta-massas com expulsor blossom



ref.	Cms.		Bar Code
788402	0,6-0,7-0,8	6/24	8411922088496

SET 3 CORTADORES CON EXPULSOR CUADRADO

set of 3 cutters with ejector square
 set 3 emporte-pièces avec pousoir carré
 set 3 tagliapasta espulsione quadrato
 jogo 3 corta-massas com expulsor quadrado



ref.	cms.		Bar Code
788405	0,6+1+1,5	6/24	8411922089844

SET 3 CORTADORES CON EXPULSOR REDONDO

set of 3 cutters with ejector round
 set 3 emporte-pièces avec pousoir rond
 set 3 tagliapasta espulsione tondo
 jogo 3 corta-massas com expulsor redondo

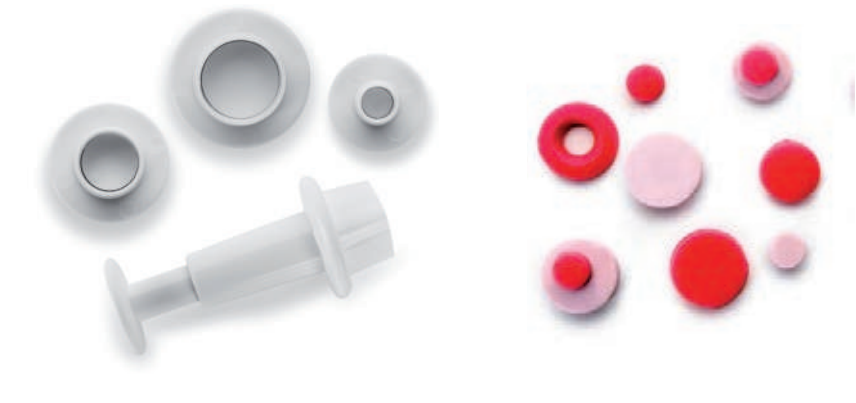

ref.	cms.		Bar Code
788407	0,6+1+1,3	6/24	8411922089868

SET 3 CORTADORES CON EXPULSOR CORAZÓN

set of 3 cutters with ejector heart
 set 3 emporte-pièces avec pousoir coeur
 set 3 tagliapasta espulsione cuore
 jogo 3 corta-massas com expulsor coração



ref.	cms.		Bar Code
788408	0,6+1+1,3	6/24	8411922089875

SET 3 CORTADORES CON EXPULSOR ESTRELLA

set of 3 cutters with ejector star
 set 3 emporta-pièces avec pousoir étoile
 set 3 tagliapasta espulsioni stella
 jogo 3 corta-massas com expulsor estrella



ref.	Cms.		Bar Code
788403	0,7-1,0-1,2	6/24	8411922088502

SET 3 CORTADORES CON EXPULSOR NUBES

set of 3 cutters with ejector clouds
 set 3 emporte-pièces avec pousoir nuages
 set 3 tagliapasta espulsione nubi
 jogo 3 corta-massas com expulsor nuvens

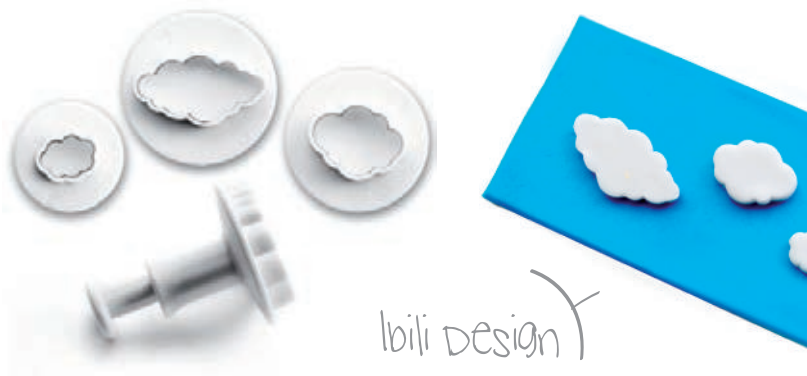

ref.	cms.		Bar Code
788409	1,3+2+3	6/144	8411922090048

SET 4 CORTADORES CON EXPULSOR MARGARITA

set of 4 cutters with ejector daisy
 set 4 emporte-pièces avec pousoir marguerite
 set 4 tagliapasta espulsione margherita
 jogo 4 corta-massas com expulsor margarida



ref.	cms.		Bar Code
788406	1,4+2+2,7+3,5	6/144	8411922089851

SET 3 CORTAPASTAS CON EXPULSOR COPO DE NIEVE

set 3 cookie cutters with ejector snowflake
 set 3 emporte-pièces avec pousoir flocon de neige
 lot 3 taglia biscotti icon espulsore fiocco di neve
 jojo 3 corta-massas com expulsor fioco de neve



ref.	cms.		Bar Code
788411	2,5+4+5,5	6/72	8411922433982

JUEGO 6 PINCELES PARA REPOSTERIA

set 6 pastry brushes
lot 6 pinceaux à pâtisserie
set 6 pennelli da pasticceria
jogo 6 pincéis de confeitaria



ref.	cms.		Bar Code
791200	22	6/96	8411922090659

MOLDE 3D ORLAS

3D mould trim
moule 3D bordures
stampo 3D bordi
forma 3D orlas

libili design

LFGB SILICONE



ref.	cms.	H		Bar Code
872207	7x14,5	1	1/6/144	8411922090093

MOLDE 3D MARCOS

3D mould frames
moule 3D cadres
stampo 3D trama
forma 3D marcos

libili design

LFGB SILICONE



ref.	cms.	H		Bar Code
872208	8,3x17	1	1/6/144	8411922090109

MOLDE 3D CRUCES

3D mould crosses
moule 3D croix
stampo 3D croci
forma 3D cruces

libili design

LFGB SILICONE



ref.	cms.	H		Bar Code
872209	8x12,5	1	1/6/144	8411922090116

MOLDE 3D BEBÉ

baby 3D mould
moule 3D bébé
stampo 3D bebé
forma 3D bebé

LFGB SILICONE



ref.	cms.	H		Bar Code
872201	8x6,5	1,5	1/6/72	8411922089783

MOLDE 3D BOTONES

buttons 3D mould
moule 3D boutons
stampo 3D bottoni
forma 3D botões

LFGB SILICONE



ref.	cms.	H		Bar Code
872204	11x5,7	1	1/6/72	8411922089813

MOLDE 3D ANGEL

angel 3D mould
moule 3D ange
stampo 3D angelo
forma 3D anjo

LFGB SILICONE



ref.	cms.	H		Bar Code
872206	9,6x6,2	1,7	1/6/72	8411922089837

MOLDES 3D CAMAFEOS DAMA

cameo 3D mould
moule 3D camées
stampo 3D camei
forma 3D camafeus

LFGB SILICONE

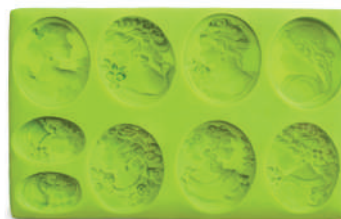

ref.	cms.	H		Bar Code
872202	12x8,5	0,8	1/6/72	8411922089790

MOLDE 3D CADENA PERLAS

3D mould pearls
moule 3D perles
stampo 3D perle
forma 3D perolas

LFGB SILICONE



ref.	cms.		Bar Code
872210	15x3,5	1/6/96	8411922090420

MOLDES 3D FLORES

flowers moulds 3D
moule 3D fleurs
stampo 3D fiori
forma 3D flores

LFGB SILICONE



ref.	cms.	H		Bar Code
872203	10x11	1,5	1/6/72	8411922089806

MOLDE 3D FLOR+HOJA+CORTADOR

3D mould flower+leaf+cutter
 moule 3D fleur+jenille+emporte-pièce
 stampo 3D fiori+joglia+taglia biscotti
 forma 3D flor+folha+cortamassas

LFGB SILICONE

ibili design



ref.	cms.		Bar Code
789100	4,5+3,5	1/6/72	8411922089974

CUCHILLO PARA FONDANT

fondant knife
 couteau pour fondant
 coltello per fondente
 faca para fondant

PLASTIC



ref.	Cms.		Bar Code
754500	27	6/24	8411922087239

MINISELLOS PARA HUELLAS FONDANT

mini-stamps for fingerprints fondant
 mini-timbres pour empreintes fondant
 mini timbro per impronte
 mini-carimbos para imprimir

ibili design

LFGB SILICONE



ref.	∅		Bar Code
789600	2,5+1,5	6/144	8411922090079

PINZAS PARA FONDANT (10 pc)

crimpers for fondant (10 pc)
 pinces pour fondant (10pc)
 pinze per fondant (10pc)
 pinças para fondant (10pc)

PLASTIC

ibili Sweet



ref.	cms.		Bar Code
789200	10	6/72	8411922089981

PINZAS PARA FONDANT DENTADAS

jagged serrated crimpers for fondant
 pinces dentelés por fondant
 pinze seghettati per fondant
 pinças dentadas para fondant

PLASTIC



ref.	cms.		Bar Code
789250	10	6/72	8411922091854







cafetería

coffe & tea

cafétéria

Kaffee & Tee

cafetaria

Essential	200
Indubasic	200
Moca	200
Elba	201
Evva	201
Toscana	202
Veneto	202
Bahía	203
Bahía Black	203
Bahía Red	203
Kristall	205
Oriental	205
Clásica	213
Prisma	213
Dispensadores Nespresso	219
Dispensadores Dolce Gusto	219
Hidratación alu	220
Hidratación glass	220
Hidratación tritan	222
Termos	223

Essential

ACERO INOXIDABLE
STAINLESS STEEL
INOX
EDELSTAHL
INOX



CAFETERA EXPRESS ESSENTIAL

espresso coffee maker
cafetière expresso
cafeteira expresso



2 JUNTAS SILICONA + 1 FILTRO ESSENTIAL

2 silicone gaskets + 1 filter essential
2 joints silicone + 1 filtre essential
2 Guarnizioni silicone + 1filtro Essential
2 juntas silicona + 1 filtro essential



ref.	☕	ml	📦	Bar Code
620302	2	100	1/6	8411922084320
620304	4	200	1/6	8411922084337
620306	6	300	1/6	8411922084344
620310	10	500	1/6	8411922084351

ref.	☕	📦	Bar Code
620350	2	6/24	8411922086669
620351	4	6/24	8411922086676
620352	6	6/24	8411922086683
620353	10	6/24	8411922086690

Indubasic

ACERO INOXIDABLE. ASA BAQUELITA
STAINLESS STEEL. BAKELITE HANDLE
INOX. ANSE BAKELITE
EDELSTAHL. BAKELITGRIFF
INOX. ASA BAKELITE



CAFETERA EXPRESS INDUBASIC

espresso coffee maker
cafetière expresso
cafeteira expresso



JUNTA DE SILICONA CAFETERA Indubasic&Induplus (2 pcs)

silicone gasket coffee maker (2 pcs)
joints silicone cafetière (2 pcs)
junta silicona cafeteira (2 pcs)



ref.	☕	ml	📦	Bar Code
611302	2	100	1/24	8411922071566
611304	4	185	1/24	8411922071573
611306	6	280	1/8	8411922071580
611312	12	500	1/12	8411922071597

ref.	☕	📦	Bar Code
611358	2	6/144	8411922072471
611359	4	6/144	8411922072488
611360	6	6/144	8411922072495
611361	12	6/144	8411922072501

Moca

ACERO INOXIDABLE. ASA BAQUELITA
STAINLESS STEEL. BAKELITE HANDLE
INOX. ANSE BAKELITE
EDELSTAHL. BAKELITGRIFF
INOX. ASA BAKELITE



CAFETERA EXPRESS

espresso coffee maker
cafetière express
kaffeemaschine express
cafeteira expresso



TRATAMIENTO INTERIOR SANDBLASTING INSIDE



ref.	☕	ml	📦	Bar Code
611002	2	100	1/6	8411922449730
611004	4	185	1/6	8411922449747
611006	6	280	1/6	8411922449754
611010	10	460	1/6	8411922449761
611015	15	700	1/6	8411922451535

Elba

ALUMINIO FUNDIDO. ACERO INOXIDABLE. ASA BAQUELITA
 CAST ALUMINIUM. STAINLESS STEEL. BAKELITE HANDLE
 ALUMINIUM EN FONTE. INOX. ANSE BAKELITE
 ALLUMINIO FUSO. EDELSTAHL. BAKELITGRIF
 ALUMINIO FUNDIDO. INOX. ASA BAKELITE



CAFETERA EXPRESS

espresso coffee maker
 cafetière express
 kaffeemaschine express
 cafeteira expresso

Cuerpo inferior acero inoxidable
 Cuerpo superior aluminio fundido
 Stainless/stell bottom part
 Aluminium upper part

TRATAMIENTO INTERIOR
 SANDBLASTING INSIDE

NEW



ref.	☕	ml	📦	Bar Code
627903	3	150	1/6	8411922460360
627906	6	300	1/6	8411922460377
627909	9	450	1/6	8411922460384

Evva

ALUMINIO FUNDIDO. ACERO INOXIDABLE. ASA BAQUELITA
 CAST ALUMINIUM. STAINLESS STEEL. BAKELITE HANDLE
 ALUMINIUM EN FONTE. INOX. ANSE BAKELITE
 ALLUMINIO FUSO. EDELSTAHL. BAKELITGRIF
 ALUMINIO FUNDIDO. INOX. ASA BAKELITE

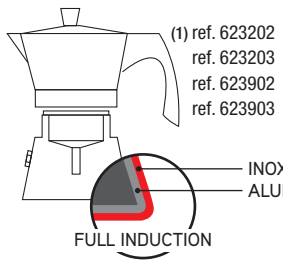

Full induction
 máxima eficiencia
 energética



(2) ref. 623106
 ref. 623206
 ref. 623906

Con reductor para tres tazas
 With reduction filter

ibili design



EVVA Black



EVVA Red



EVVA Golden

ref.	☕	ml	📦	Bar Code
623106	3/6	300	1/6	8411922436938
623109	9	450	1/6	8411922436945
623112	12	600	1/6	8411922436952

ref.	☕	ml	📦	Bar Code
(2) 623202	2	100	1/6	8411922440997
623203	3	150	1/6	8411922436969
623206	6	300	1/6	8411922436976
623209	9	450	1/6	8411922436983
623212	12	600	1/6	8411922436990

ref.	☕	ml	📦	Bar Code
(1) 623903	3	150	1/6	8411922441017
(1) 623906	3/6	300	1/6	8411922439243
(2) 623909	9	450	1/6	8411922439250
623912	12	600	1/6	8411922439267

(1)
(2)



CAFETERA EXPRESS EVVA

espresso coffee maker
cafetière express
caffettiera espresso
cafeteira expresso



Pesada y resistente
Asa desmontable
Interior pulido
Heavy and resistant
Detachable handle
Polished inside

EVVA Blue

ref.	☕	ml	📦	Bar Code	
623006	6	300	1/6	8411922451726	(2)
623009	9	450	1/6	8411922451733	(2)
623012	12	600	1/6	8411922451740	(2)

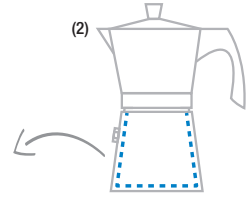

Recubrimiento interior
ANTIADHERENTE para una mayor higiene
NON-STICK interior coating for better cleaning

Toscana

ALUMINIO FUNDIDO. ASA BAQUELITA
CAST ALUMINIUM. BAKELITE HANDLE
ALUMINIUM EN FONTE. ANSE BAKELITE
ALLUMINIO FUSO. BAKELITGRIF
ALUMINIO FUNDIDO. ASA BAKELITE



CAFETERA TOSCANA

espresso coffee maker
cafetière express
caffettiera espresso
cafeteira expresso



(1) Con reductor para tres tazas
With reduction filter

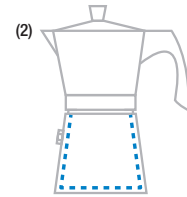

Recubrimiento interior
ANTIADHERENTE para una mayor higiene
NON-STICK interior coating for better cleaning

estilo madera
wooden style

ref.	☕	ml	📦	Bar Code	
622106	3/6	300	1/6	8411922457049	(1)(2)
622109	9	400	1/6	8411922457056	(2)
622112	12	600	1/6	8411922457063	(2)

Veneto

ALUMINIO FUNDIDO. ASA BAQUELITA
CAST ALUMINIUM. BAKELITE HANDLE
ALUMINIUM EN FONTE. ANSE BAKELITE
ALLUMINIO FUSO. BAKELITGRIF
ALUMINIO FUNDIDO. ASA BAKELITE



CAFETERA VENETO

espresso coffee maker
cafetière express
caffettiera espresso
cafeteira expresso

NEW

loili design



(1) Con reductor para tres tazas
With reduction filter

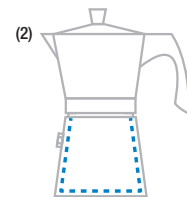

Recubrimiento interior
ANTIADHERENTE para una mayor higiene
NON-STICK interior coating for better cleaning

ref.	☕	ml	📦	Bar Code	
627806	3/6	300	1/6	8411922459784	(1)(2)
627809	9	400	1/6	8411922459791	(2)
627812	12	600	1/6	8411922459807	(2)

Bahía

ALUMINIO FUNDIDO. ASA BAQUELITA
CAST ALUMINIUM. BAKELITE HANDLE
ALUMINIUM EN FONTE. ANSE BAKELITE
ALLUMINIO FUSO. BAKELITGRIF
ALUMINIO FUNDIDO. ASA BAKELITE

special



vitro



electric



gas



CAFETERA EXPRESS ALU

espresso coffee maker alu

cafetière expresso alu

cafeteira expresso alu

ref.	☺	ml	☐	Bar Code
610903	3	150	1/6	8411922431902
610906	6	300	1/6	8411922431919
610909	9	450	1/6	8411922431926
610912	12	600	1/6	8411922431933
610914	14	700	1/6	8411922440621

Bahía Black

ALUMINIO FUNDIDO. ASA BAQUELITA
CAST ALUMINIUM. BAKELITE HANDLE
ALUMINIUM EN FONTE. ANSE BAKELITE
ALLUMINIO FUSO. BAKELITGRIF
ALUMINIO FUNDIDO. ASA BAKELITE

special



vitro



electric



gas



CAFETERA EXPRESS NEGRA

black expreso coffee maker

cafetière expresso noir

cafeteira expresso preta

ref.	☺	ml	☐	Bar Code
612201	1	50	1/6	8411922083726
612203	3	150	1/6	8411922082913
612206	6	300	1/6	8411922082920
612209	9	600	1/6	8411922082937
612212	12	700	1/6	8411922082944

Bahía Red

ALUMINIO FUNDIDO. ASA BAQUELITA
CAST ALUMINIUM. BAKELITE HANDLE
ALUMINIUM EN FONTE. ANSE BAKELITE
ALLUMINIO FUSO. BAKELITGRIF
ALUMINIO FUNDIDO. ASA BAKELITE

special



vitro



electric



gas



CAFETERA EXPRESS

espresso coffee maker

cafetière express

kaffeemaschine express

cafeteira expresso

ref.	☺	ml	☐	Bar Code
612303	3	150	1/6/12	8411922444087
612306	6	300	1/6/12	8411922444094
612309	9	450	1/6/12	8411922445008
612312	12	600	1/6	8411922445015

ADAPTADOR INDUCCIÓN PARA CAFETERAS

induction-vitrocermic adapter
for coffee makers

adaptateur induction-
vitrocéramique pour cafetières

induktionsadapter-glaskeramik
für kaffeekoher

adaptador indução

vitrocèramica para cafeteiras



ref.	Ø	☐	Bar Code
705312	12	4/12	8411922452426

JUNTA CAFETERA Bahía (2 pcs)

gasket coffee maker (2 pcs)

joint cafetière (2 pcs)

junta cafeteira (2 pcs)

SILICONE



ref.	☺	ml	☐	Bar Code
610958	3	150	6/144	8411922073072
610959	6	300	6/144	8411922073089
610960	9	450	6/144	8411922073096
610961	12	600	6/144	8411922073102

JARRA DE BOROSILICATO

borosilicate glass pitcher
pichet en verre de borosilicate
krug aus borosilikatglas
jarra de vidro de borosilicato

Para puerta de nevera
For refrigerator door

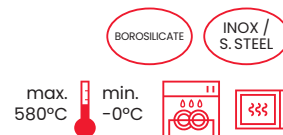

ref.	Lts.	Ø	H	☐	Bar Code
626011	1,1	8	24	6	8411922452976
626015	1,5	9	28	6	8411922452983

CAFETERA ÉBOLO

plunger coffee maker
cafetière embolo
caffettiera embolo
cafeteira embolo



ref.	ml	☐	Bar Code
623703	0,350	1/6/24	8411922439151
623706	0,600	1/6/24	8411922439168
623710	1,000	1/6/12	8411922439175

CAFETERA-EMBOLO

plunger coffee maker
cafetière embolo
caffettiera embolo
cafeteira embolo



ref.	Lts.	☐	Bar Code
625406	0,600	1/6/24	8411922449846
625408	0,800	1/6/24	8411922449853
625410	1,000	1/6/24	8411922449860

Kristall



TETERA CON FILTRO STOVE

teapot with filter STOVE
théière avec filtre STOVE
teiera con filtro STOVE
chaleira com filtro STOVE



PERFECTO FILTRADO
perfect filtered
filtration parfaite
perfetto filtraggio
perfeita filtragem



Filtro extraíbe

ref.	Lts.	📦	Bar Code
621704	0,450	1/24	8411922090895
621708	0,800	1/6	8411922434712

TETERA CON FILTRO INDUCTION

teapot with filter INDUCTION
théière avec filtre INDUCTION
teiera con filtro INDUCTION
chaleira com filtro INDUCTION



PERFECTO FILTRADO
perfect filtered
filtration parfaite
perfetto filtraggio
perfeita filtragem



ref.	Lts.	📦	Bar Code
621908	800	1/24	8411922090901
621912	1200	1/12	8411922090918

JARRA DE BOROSILICATO

borosilicate glass pitcher
pichet en verre de borosilicate
krug aus borosilikatglas
jarra de vidro de borossilicato

ibili design



ref.	Lts.	📦	Bar Code
624903	0,35	6/36	8411922441420
624906	0,60	6/24	8411922441437
624910	1,00	6/24	8411922441444
624912	1,20	6/24	8411922441451

HERVIDOR C/ FILTRO SQUARE

tea boiler with filter square
théière avec filtre square
bollitore per té
con filtro square
fervedor de chá
com filtro square



ref.	ml	📦	Bar Code
625506	600	1/6/24	8411922449952
625510	1000	1/6/24	8411922449969

Oriental

CON FILTRO INOX / INTERIOR ESMALTADO
WITH S/STEEL FILTER / ENAMELLED INSIDE



TETERA HIERRO FUNDIDO

Cast iron tea pot
Théière en fer fondue
Schwarze Teekanne aus Gusseisen
Chaleira de ferro fundido

IZUM



NEW



ref.	Lts.	📦	Bar Code
627511	1,100	1/6	8411922459425

TETERA HIERRO FUNDIDO **NEGARA**

cast iron teapot
théière en fer fondue
teekanne aus gusseisen
chaleira de ferro fundido



ref.	Lts.		filter	Bar Code
626608	0,8	1/6	620804	8411922454338

TETERA HIERRO FUNDIDO **EL CAIRO**

cast iron teapot
théière en fer fondue
teekanne aus gusseisen
chaleira de ferro fundido



ref.	lts.		filter	Bar Code
626712	1,2	1/6	620801	8411922454345

TETERA HIERRO FUNDIDO **LOMBOK**

cast iron teapot
théière en fer fondue
teekanne aus gusseisen
chaleira de ferro fundido



ref.	lts.		Bar Code
626811	1,1	1/6	8411922454352

TETERA HIERRO FUNDIDO **NEGRA**

cast iron teapot
théière en fer fondue
teekanne aus gusseisen
chaleira de ferro fundido



ref.	Lts.		filter	Bar Code
620003	0,3	1/6	620804	8411922081763
620007	0,72	1/6	620806	8411922080865
620012	1,20	1/6	620801	8411922080872
620018	1,80	1/6	-	8411922458534

TETERA HIERRO FUNDIDO **CEYLAN**

cast iron teapot
théière en fer fondue
teekanne aus gusseisen
chaleira de ferro fundido



ref.	lts.		Bar Code
620407	0,7	1/6	8411922084986

TETERA HIERRO FUNDIDO **JAVA**

cast iron teapot
théière en fer fondue
teekanne aus gusseisen
chaleira de ferro fundido



ref.	Lts		filter	Bar Code
621510	1	1/8	620806	8411922088922

TETERA HIERRO FUNDIDO **BALI**

cast iron teapot
théière en fer fondue
teekanne aus gusseisen
chaleira de ferro fundido



ref.	Lts		Bar Code
621612	1,2	1/6	8411922088939

TETERA HIERRO FUNDIDO **MALASIA**

cast iron teapot
théière en fer fondue
teekanne aus gusseisen
chaleira de ferro fundido



ref.	Lts		Bar Code
621408	0,8	1/8	8411922088915

TETERA HIERRO FUNDIDO **AZUL**

blue cast iron teapot
théière en fer fondue bleu
chaleira de ferro fundido azul



ref.	Lts.		filter	Bar Code
620212	1,2	1/6	620801	8411922080896

TETERA HIERRO FUNDIDO **VERDE**

green cast iron teapot
théière en fer fondue verte
chaleira de ferro fundido verde



ref.	Lts.		filter	Bar Code
620107	0,78	1/6	620806	8411922080889

TETERA HIERRO FUNDIDO **HANOI**

cast iron teapot
théière en fer fondue
teekanne aus gusseisen
chaleira de ferro fundido



ref.	Lts.		filter	Bar Code
622603	0,30	1/6	620804	8411922435450

TETERA HIERRO FUNDIDO **LAOS**

cast iron teapot
théière en fer fondue
teekanne aus gusseisen
chaleira de ferro fundido



ref.	Lts.		Bar Code
620904	0,300	1/6	8411922086706

TETERA HIERRO FUNDIDO **NEPAL**

cast iron teapot
théière en fer fondue
teekanne aus gusseisen
chaleira de ferro fundido



ref.	Lts.		Bar Code
622805	0,50	1/6	8411922435474

TETERA HIERRO FUNDIDO **SANA**

cast iron teapot
théière en fer fondue
teekanne aus gusseisen
chaleira de ferro fundido



ref.	Lts.		Bar Code
625706	0,600	1/6	8411922451498

TETERA HIERRO FUNDIDO **DOHA**

cast iron teapot
théière en fer fondue
teekanne aus gusseisen
chaleira de ferro fundido



ref.	Lts.		Bar Code
625603	0,300	1/6	8411922451801

TETERA HIERRO FUNDIDO LUANG

cast iron teapot
théière en fer fondue
teekanne aus gusseisen
chaleira de ferro fundido



ref.	Lts.		Bar Code
627407	0,70	1/6	8411922458756

TETERA HIERRO FUNDIDO MANAOS

cast iron teapot
théière en fer fondue
teekanne aus gusseisen
chaleira de ferro fundido



ref.	Lts.		Filter	Bar Code
624003	0,300	1/6	620804	8411922439373

TETERA HIERRO FUNDIDO GRAFITTI

cast iron teapot
théière en fer fondue
teekanne aus gusseisen
chaleira de ferro fundido



ref.	Lts.		Filter	Bar Code
624303	0,350	1/6	620804	8411922439403

TETERA HIERRO FUNDIDO KUTA

cast iron teapot
théière en fer fondue
teekanne aus gusseisen
chaleira de ferro fundido



ref.	Lts.		Bar Code
624103	0,300	1/6	8411922439380

TETERA HIERRO FUNDIDO OSAKA

cast iron teapot
théière en fer fondue
teekanne aus gusseisen
chaleira de ferro fundido



ref.	Lts.		Filter	Bar Code
624204	0,320	1/6	620804	8411922439397

TETERA HIERRO FUNDIDO **INDIA**

cast iron teapot
théière en fer fondue
teekanne aus gusseisen
chaleira de ferro fundido



ref.	lts.		filter	Bar Code
620508	0,8	1/8	620806	8411922084993

TETERA HIERRO FUNDIDO **KERALA**

cast iron teapot
théière en fer fondue
teekanne aus gusseisen
chaleira de ferro fundido



ref.	Lts.		Bar Code
626912	1,2	1/6	8411922455533

TETERA HIERRO FUNDIDO **DACA**

cast iron teapot
théière en fer fondue
teekanne aus gusseisen
chaleira de ferro fundido



ref.	Lts.		Bar Code
625808	0,850	1/6	8411922451504

TETERA HIERRO FUNDIDO **NARA**

cast iron teapot
théière en fer fondue
teekanne aus gusseisen
chaleira de ferro fundido



ref.	Lts.		Filter	Bar Code
620712	1,2	1/24	620801	8411922440546

TETERA HIERRO FUNDIDO **YUNAN**

cast iron teapot
théière en fer fondue
teekanne aus gusseisen
chaleira de ferro fundido



ref.	lts.		Bar Code
627308	0,8	1/6	8411922458527

REPOSATETERAS BALI

teapot trivet
support pour théière
supporto per teiera
descanso para chaleiras



ref.	Cms.		Bar Code
621030	15	1/6	8411922440522

REPOSATETERAS SAIGON

teapot trivet
support pour théière
supporto per teiera
descanso para chaleiras



ref.	Cms.		Bar Code
621005	13,5	1/6	8411922454314

REPOSATETERAS PERTH

teapot trivet
support pour théière
supporto per teiera
descanso para chaleiras



ref.	Cms.		Bar Code
621015	13	1/6	8411922454321

REPOSATETERAS JAVA

teapot trivet
support pour théière
supporto per teiera
descanso para chaleiras



ref.	Cms.		Bar Code
621040	15	1/6	8411922440539

REPOSATETERAS PLANO Universal

teapot trivet
support pour théière
supporto per teiera
descanso para chaleiras



ref.	Cms.		Bar Code
621000	13	1/6	8411922086713

FILTRO PARA TETERA

filter for teapot
filtre pour théière
filtro per teiera
filtro para teiera

ref.	Cms.	H		Bar Code
620801	9	6	6/6	8411922085976
620804	7	4,5	6/6	8411922086003
620806	8,2	5,1	6/6	8411922086027

Teapot 620012+620212+626712+620712

Teapot 620003+620904+622104+625003+622603+624003+624103+622608

Teapot 620007+620508



INOX /
S. STEEL
18/10

SET 2 TAZAS Y PLATILLOS HIERRO FUNDIDO CLÁSICA

set 2 cast iron mugs with plate Clásica
set 2 gobelets en fer fondué avec assiette Clásica
set 2 tazzine in ghisa con piattini Clásica
set 2 canecas de ferro fundido com prato Clásica



ref.	Lts.		Bar Code
624400	0,120	1/6	8411922439410

CALENTADOR DE TETERAS HIERRO FUNDIDO

cast iron teapot warmer
chauffe-théières en fer fondu
teestövchen
aquecedor para bules de ferro fundido



ref.	Ø	H.	📦	Bar Code
625300	14	7	1/6	8411922448153

TETERA ARABE MAHDIA

teapot mahdia
théière mahdia
teekanne mahdia
chaleira mahdia



ref.	Lts.	📦	Bar Code
611950	0,65	1/6	8411922454833
611951	1,00	1/6	8411922454840
611952	1,40	1/6	8411922454857

TETERA ARABE EL YADIDA

teapot el yadida
théière el yadida
teekanne el yadida
chaleira el yadida



ref.	Lts.	📦	Bar Code
612050	0,65	1/6	8411922454864
612051	1,00	1/6	8411922454871
612052	1,40	1/6	8411922454888

CAFETERA PAVA

kettle
bouilloire
cafeteira

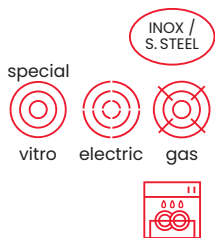

ref.	Lts.	📦	Bar Code
610201	1,45	1/12	8411922421163
610202	2,75	1/6	8411922421262
610203	3,8	1/6	8411922421361
610204	4,8	1/6	8411922421552



TETERA ARABE AGADIR

teapot agadir
théière agadir
teekanne agadir
chaleira agadir

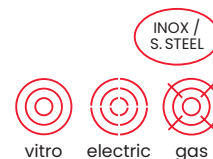

individual
small size

ref.	Lts.	📦	Bar Code
612103	0,300	1/6	8411922457117
612104	0,450	1/6	8411922457124

Clásica



CAFETERA SILBANTE Asa abatible. Satinado

whistling kettle. Folding handle.
Satin finished
bouilloire sifflante. Anse pliante.
Satiné
cafeteira com apito. Asa amovible.
Satinado

INOX / S.STEEL



ref.	lts.	☐	Bar Code
610415	1,5	1/6	8411922207873
610425	2,5	1/6	8411922205671

CAFETERA SILBANTE MARMORE

whistling kettle
bouilloire sifflante
flötenkessel
cafeteira com apito

INOX / S.STEEL



ref.	Lts.	☐	Bar Code
610425M	2,50	1/6	8411922451801

CAFETERA SILBANTE BLANCA

whistling kettle blanca
bouilloire sifflante blanca
flötenkessel blanca
cafeteira com apito blanca

INOX / S.STEEL



ref.	Lts.	☐	Bar Code
610425B	2,5	1/6	8411922448504

INOX / S.STEEL



ref.	Lts.	☐	Bar Code
610425N	2,5	1/6	8411922448511

CAFETERA SILBANTE NEGRA

whistling kettle negra
bouilloire sifflante negra
flötenkessel negra
cafeteira com apito negra

Prisma

ACERO INOXIDABLE 18/10
STAINLESS STEEL 18/10
INOX 18/10
INOX 18/10



CAFETERA PAVA CON FILTRO

kettle with filter
bouilloire avec filtre
cafeteira com filtro

INOX / S.STEEL



ref.	lts.	☐	Bar Code
610109	0,8	1/6	8411922069037
610115	1,3	1/6	8411922208092
610120	1,8	1/6	8411922069051

SET PARA MATE 4 PIEZAS

4-piece mate set.
Ensemble à maté 4 pièces.
4-teiliges Matetee-Set.
Conjunto de 4 peças para mate.

*Doble pared
vacío interior
vaccum double wall*

INOX / S. STEEL



- 1. VASO / CUP
- 2. BOMBILLA REDONDA / ROUND BOMBILLA
- 3. BOMBILLA PLANA / PLANE BOMBILLA
- 4. CEPILLO / BRUSH



ref.	Lts.	Ø	H	📦	Bar Code
685800	0,25	7,5	10,8	1/6	8411922459012

BATIDOR DE LECHE

milk frother
fouet à lait
milchschräger
batedor de leite

INOX / S. STEEL

~~🔋~~
2 x AAA
not included



*Diferentes usos: leche,
huevos, chocolate ...
Different usings: milk,
eggs, chocolate ...*

ref.	cms.	📦	Bar Code
778110	20,5	6/48	8411922448566

SET 4 PAJITAS INOX + CEPILLO LIMPIADOR

set of 4 stainless-steel straws + cleaning brush
set 4 pailles inox + brosse de nettoyage
4er-set edelstahl-strohhalme + reinigungsbürste
conjunto de 4 palhinhas inox + escova de limpeza

INOX / S. STEEL



ref.	Cms	Ø	📦	Bar Code
702110	25	0,8	6/24	8411922448894

DESCALCIFICADOR DE TETERAS

kettle descaler
anti-calcaire pour théières
teebereiter-entkalker
descalcificador de bules

INOX / S. STEEL

Al hervir con el agua absorbe la cal de la tetera
Limescale fur will collect on the wire as the water boils

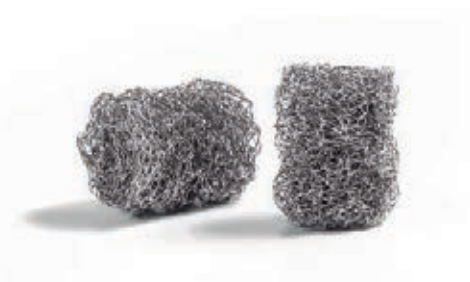

ref.	Cms.	📦	Bar Code
782110	2,5x3,5	6/144	8411922448573

SET 3 DECORADORES DE ESPUMA GRANDES

set 3 cocoa stencils large

set 3 elements de décoration de mousse grands

jogo 3 moldes de espuma grandes



ref.	cms.		Bar Code
778200	10	6/72	8411922080599

CAJA DE TÉ 6 COMPARTIMENTOS

tea box 6 compartments

boîte à thé 6 compartiments

scatola da the 6 scomparti

caixa para chás 6 compartimentos



PINO/
PINE

CAJA DE TÉ 9 COMPARTIMENTOS

tea box 9 compartments

boîte à thé 9 compartiments

scatola da the 9 scomparti

caixa para chás 9 compartimentos



PINO/
PINE

ref.	cms.		Bar Code
748500	18x21,5x7	6/24	8411922437829

AZUL

ref.	cms.		Bar Code
748550	24x24x7	6/12	8411922437843

AZUL

COLADOR DE FRANELA

flannel strainer

passoire flanelle

filtro di flanella

coador flanela



ref.	cms.		Bar Code
797810	10	12/48	8411922433418
797812	12	12/48	8411922433425
797814	14	12/48	8411922433432

FILTRO PERMANENTE DE TÉ Y CAFÉ

permanent tea and coffee filter

filtre permanent à thé et café

filtro permanente de cha e café

INOX /
S. STEEL
18/10



ref.	cms.	lts.		Bar Code
611700	6	7,5	1	8411922072792

FILTRO PARA TÉ

filter for tea

filtre pour thé

filtro per tè

filtro para chá



INOX /
S. STEEL
18/10

ref.	Ø	H.		Bar Code
741508	6	7,3	1/6/48	8411922435252

FILTRO DE CAFÉ Y CUCHARA PLÁSTICO (display)

coffee filter and spoon, plastic (display)
 filtre à café et cuillère, plastique (display)
 filtro de café e colher, plástico (display)



ref.	cms.	lts.	📦	Bar Code
760900	12,5	10,5	10	8411922621815

CUCHARA DE TE (blister)

tea spoon (blister)
 cuillère à thé (blister)
 colher para chá (blister)

INOX/
S. STEEL
18/10



ref.	📦	Bar Code
702900	6	8411922208009

BOLA DE TE (blister)

tea ball (blister)
 boule à thé (blister)
 passador esférico para Chá (blister)

INOX/
S. STEEL
18/10



ref.	cms.	📦	Bar Code
761600	4	12	8411922621884

BOLA DE TÉ (blister)

tea ball (blister)
 boule à thé (blister)
 passador esférico para Chá (blister)

INOX/
S. STEEL
18/10



ref.	📦	Bar Code
702800	6	8411922207996

PINZA BOLA DE TÉ (blister)

tea ball tong (blister)
 pince à thé (blister)
 pinça passador para Chá (blister)

INOX/
S. STEEL
18/10



ref.	∅	H	📦	Bar Code
703200	4	18	12	8411922209280
703206	6,5	18	6/144	8411922091779

INFUSOR DE TÉ TUBO

tube tea infuser
 infuseur à tube
 infusiere per té a forma di tubo
 infusor de chá tubo

INOX/
S. STEEL
18/10



ref.	Cms.	📦	Bar Code
731500	16	6/60	8411922086126

VASO DE TÉ CON FILTRO

tea glass with filter
 verre à thé avec filtre
 bicchiere da tè c/filtro
 copo de chá com filtro

DOBLE PARED
 double inner wall
 intérieure à doublé paroi
 doppia parete interna
 parede dupla



SILICONE

BOROSILICATE

INOX/
S. STEEL
18/10



ref.	H.	∅	Lts.	📦	Bar Code
622405	13,5	6	0,250	1/6/24	8411922435245

INFUSOR DE TE GREEN

leaf tea infuser green
 boule à thé green
 infusore per té green
 infusor para chá green

SILICONE

INOX/
S. STEEL



ref.	Cms.	📦	Bar Code
742000	16	6/72	8411922435313

TAZA DE TE CON FILTRO DE VIDRIO SALVIA

tea glass with filter
verre à thé avec filtre
bicchiere da tè c/filtro
copo de chá com filtro



ref.	Lts.		Bar Code
624500	0,400	1/6/24	8411922440225

BOROSILICATE

TAZAS PARA CAFÉ Y TÉ

Coffee & tea cups
Tasses à café et à thé
Tassen für Kaffee und Tee
Chávenas para café e chá

BOROSILICATE

SET 2

Double pared
double wall



ref.	Ø	Lts.	H.		Bar Code
685015	7	0,15	8	1/6/36	8411922458039
685022	8	0,22	9	1/6/24	8411922458046

JUEGO 6 VASOS PARA TÉ

Set of 6 tea glasses
Ensemble de 6 verres à thé
Teeservice mit 6 gläsern
Conjunto de 6 copos para chá

GLASS



ref.	Ø.	Lts.	H		Bar Code
685100	5,5	0,13	10	6	8411922458077

TAZA DE VIDRIO

glass cup
tasse en verre
tazza in vetro
taça de vidro



BOROSILICATE

max. 240°C
min. -40°C

8 pieces

2X

2X

2X

2X



ref.	Ø	H	Lts.		Bar Code
623803	8	8,5	0,30	8/24	8411922439182

No absorbe ni olores ni sabores. No se raya.
Won't absorb odours or flavours. Scratch resistant.

MOLINILLO DE CAFÉ

coffee grinder
moulin à café
kaffeemühle
moinho de café

Adjustable
Adjustable



Muela cerámica
Ceramic grinder

BOROSILICATE



ref.	Lts.	Ø	H	📦	Bar Code
705810	0,350	8	18	1/6/18	8411922449587

MOLINILLO DE CAFÉ

manual coffee grinder
moulin manuel
handkaffeemühle
moinho manual

sistema de
regulación de grosor
thickness
regulation system



Marrón oscuro
dark brown



ref.	Cms	📦	Bar Code
750720	10X10	1/6/24	8411922439946

Marrón claro
light brown

MADERA/
ACERO

Molido perfecto
Perfect ground

ENVASADOR DE CÁPSULAS CAFÉ & TÉ

coffee & tea capsule filler
machine de conditionnement de capsules de café et de thé
riempitrice per capsule di caffè e té
máquina de encher cápsulas de café & chá

Compatible con sistema Nespresso
Compatible with Nespresso system

copyright



Rellena tus cápsulas plásticas de café o té compatibles con diferentes tipos de cafeteras, cuantas veces quieras. Elige ahorrar, reutilizar, reducir y reciclar.

Refill your plastic coffee or tea capsules for use with different types of coffee machines as many times as you want. Choose to save, reuse, reduce and recycle.

DO IT YOURSELF!

ECO FRIENDLY

+10 cápsulas reutilizables
reusable capsules
capsules réutilisables
capsule riutilizzabili
cápsulas reutilizáveis



ref.	Cms	📦	Bar Code
797600	19x12	1/6	8411922439717

Dispensadores Nespresso

ACERO CROMADO (CAJA LITOGRAFIADA)
CHROMED STEEL (GIFT BOX)
FIL CHROMÉ (BOÎTE INDIV.)
AÇO CROMAGEM (CAIXA INDIV.)

DISPENSADOR DE CÁPSULAS VOLCANO CAFÉ NESPRESSO

dispenser for coffee capsules
distributeur de capsules café
distributore capsules di caffè
distribuidor de capsulas café

ALUMINIUM

PLASTIC

40 ud.

GIRATORIO CUADRADO
SQUARE ROTATING



contenedor para caja de cápsulas
capsule box container



ref.	cms.	H	📦	Bar Code
720920	13x13	36	1/4/8	8411922439328

DISPENSADOR DE CÁPSULAS DE CAFÉ VESUBIO

dispenser for coffee capsules Vesubio
distributeur de capsules café Vesubio
distribuidor de capsulas de café Vesubio

36 ud.



ref.	cms.	📦	Bar Code
780010	13 x 8,7 x 22	1	8411922082302

DISPENSADOR DE CÁPSULAS DE CAFÉ FUJI

dispenser for coffee capsules Fuji
distributeur de capsules café Fuji
distribuidor de capsulas de café Fuji

44 ud.



ref.	cms.	📦	Bar Code
780020	10 x 10 x 38	1	8411922082319

DISPENSADOR GIRATORIO DE CÁPSULAS DE CAFÉ TAMBORA

revolving dispenser for coffee capsules Tambora
distributeur giratoire de capsules café Tambora
distribuidor giratorio de capsulas de café Tambora

40 ud.



ref.	cms.	📦	Bar Code
780030	11 x 41	1/6	8411922082326

Dispensadores Dolce Gusto

DISPENSADOR DE CÁPSULAS DE CAFÉ HELENS

dispenser for coffee capsules Helens
distributeur de capsules café Helens
distribuidor de capsulas de café Helens

36 ud.



ref.	cms.	📦	Bar Code
780110	24 x 9,5 x 32	1	8411922082357

DISPENSADOR DE CÁPSULAS DE CAFÉ MAUNA

dispenser for coffee capsules Mauna
distributeur de capsules café Mauna
distribuidor de capsulas de café Mauna

24 ud.



ref.	cms.	📦	Bar Code
780100	14,5 x 33	1	8411922082340

Hidratación alu



BOTELLA Alpine

bottle
bouteille
flasche
garrafa

ref.	Lts.	Ø	H	☞	Bar Code
626103S	0,500	6,0	16,5	6	8411922452990
626105B	1,000	6,5	19,5	6	8411922453010
626107S	0,300	7,3	25,0	6	8411922453003
626110B	0,750	8,0	27,0	6	8411922453027



Hidratación glass

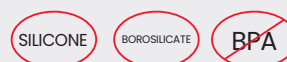

BOTELLA DE VIDRIO

glass bottle
bouteille en verre
bottiglia in vetro
garrafa de vidro

ref.	Lts.	☞	Bar Code
745903A	0,360	3/6/24	8411922436747
745903V	0,360	3/6/24	8411922436754
745905A	0,500	3/6/24	8411922436761
745905V	0,500	3/6/24	8411922436778

Sky

Azul/Blue
Verde/Green
Azul/Blue
Verde/Green



Anti-shock

perfect transparency

Lake

Rojo/Red
Verde/Green
Rojo/Red
Verde/Green



BOTELLA KID

bottle kid
bouteille kid
flasche kid
garrafa kid



ref.	Lts.	Ø	H	☞	Bar Code
758910G	0,200	6	13,5	9/18	8411922452532
758910P	0,200	6	13,5	9/18	8411922452549

GRIS/GREY
ROSA/PINK

BOTELLA

bottle
bouteille
flasche
garrafa



park

ref.	Lts.	Ø	H		Bar Code
757505P	0,500	7	22	3/6/24	8411922452785

BOTELLA

bottle
bouteille
flasche
garrafa



elegance

ref.	Lts.	Ø	H		Bar Code
757905E	0,500	6	21	3/6/24	8411922452792

BOTELLA

bottle
bouteille
flasche
garrafa

Protector de
silicona antigapés
anti-shock
silicone protector



IBILI design

base antideslizante
anti-skid base

ref.	Lts.	Ø	H		Bar Code
751703	0,360	6,5	19	3/6/24	8411922452761
751705	0,550	6,8	24	3/6/24	8411922452778

BOTELLA

bottle
bouteille
flasche
garrafa

neoprèno
neoprène

Protector
antigapés
anti-shock
protector



ref.	Lts.	Ø	H		Bar Code
758104B	0,420	6,5	20	3/6/24	8411922452808
758105B	0,550	6,5	24	3/6/24	8411922452815

BOTELLA

bottle
bouteille
flasche
garrafa

BOROSILICATE

COTTON

algodón
cotton

Protector
antigapés
anti-shock
protector



ref.	Lts.	Ø	H		Bar Code
758205G	0,550	6,5	24	3/6/24	8411922452822
758207G	0,750	7,5	23,5	3/6/24	8411922452839

Hidratacion tritan



BOTELLA SPORT

bottle sport
bouteille sport
bottiglia sport
garrafa sport



ref.	H	Lts		Bar Code
720307	25	0,72	3/6/24	8411922439571

BOTELLA SPORT

bottle sport
bouteille sport
bottiglia sport
garrafa sport



ref.	H	Lts.		Bar Code
720305	19,5	0,53	3/6/24	8411922439564

BOTELLA FRESH

bottle fresh
bouteille fresh
bottiglia fresh
garrafa fresh



TAPON INOX
S/STEEL LID

ref.	H	Lts.		Bar Code
720106	23	0,58	3/6/24	8411922439557

BOTELLA AQUA

bottle aqua
bouteille aqua
bottiglia aqua
garrafa aqua



TAPON INOX
S/STEEL LID

ref.	H	Lts.		Bar Code
720607	26	0,700	3/6/24	8411922440379
720610	30	1,000	3/6/24	8411922440386

BOTELLA FINGER

bottle finger
bouteille finger
flasche finger
garrafa finger



ref.	Lts.		Bar Code
720006	0,600	6/24	8411922448948

BOTELLA INFUSER

bottle infuser
bouteille infuser
bottiglia infuser
garrafa infuser



ref.	H	Lts.		Bar Code
720407	23,5	0,69	6/24	8411922439588

Termos

ACERO INOXIDABLE 18/10
STAINLESS STEEL 18/10
INOX 18/10
EDELSTAHL 18/10
INOX 18/10



BOTELLA TERMO DOBLE PARED

Double wall thermo bottle
Bouteille isotherme double paroi
Doppelwandige Thermoflasche
Garrafa termo de parede dupla

Diseñado por/
Designed by:

ibili design



SWIRL Nerea Agirre SURF Ana Ugarte SIA Nerea Murillo SAMBA Aritz Lekuona STIJL Asier Jiménez IMPACT Teresa Pagaegi HORIZON Ainara Urra COCOLINA Mireia Elexpe VINIKUNKA Eider Gabirondo MAREA Maitane Urkiola

ref.	Lts.	Ø	H	📦	Bar Code
762910	0,500	7	24,5	2/6/24	8411922456288
762920	0,500	7	24,5	2/6/24	8411922456295
762930	0,500	7	24,5	2/6/24	8411922456301
762940	0,500	7	24,5	2/6/24	8411922456318
762950	0,500	7	24,5	2/6/24	8411922456455

SWIRL
SURF
SIA
SAMBA
STIJL

ref.	Lts.	Ø	H	📦	Bar Code
774956	0,500	7	24,5	2/6/24	8411922458497
774955	0,500	7	24,5	2/6/24	8411922458480
774954	0,500	7	24,5	2/6/24	8411922458473
774958	0,500	7	24,5	2/6/24	8411922458510
774957	0,500	7	24,5	2/6/24	8411922458503

IMPACT
HORIZON
COCOLINA
VINIKUNKA
MAREA

TERMO SMART BOTELLA TERMO DOBLE PARED

double wall thermo bottle
bouteille thermo double paroi
doppelwandige thermoflasche
garrafa termos de parede dupla



ref.	Lts.	Ø	H	📦	Bar Code
774950	0,500	7	24,5	2/6/24	8411922454697
774951	0,500	7	24,5	2/6/24	8411922454703
774952	0,500	7	24,5	2/6/24	8411922454710
774953	0,500	7	24,5	2/6/24	8411922454727

PURE
SEA
OLIVE
HOJA

BOTELLA TERMO SMART HYDRATE & REUSE

double wall thermo bottle
bouteille thermo double paroi
doppelwandige thermoflasche
garrafa termos de parede dupla

NEW

ibili design



ref.	Lts.	Ø	H	📦	Bar Code
774959	0,500	7	24,5	12	8411922470420

TERMO CLASSIC
BOTELLA TERMO DOBLE PARED

double wall thermo bottle
bouteille thermo double paroi
doppelwandige thermoflasche
garrafa termos de parede dupla



350 ml.



ref.	Lts.	Ø	H		Bar Code
758403	0,350	7	22	12/24	8411922454499



500 ml.



ref.	Lts.	Ø	H		Bar Code
758405	0,500	7	26	12/24	8411922452556



775 ml.



ref.	Lts.	Ø	H		Bar Code
758475C	0,775	8	30,5	9	8411922457391

ZOO



350 ml.



ref.	Lts.	Ø	H		Bar Code
758435I	0,350	7	22	12/24	8411922457681

Termos

ACERO INOXIDABLE 18/10
STAINLESS STEEL 18/10
INOX 18/10
EDELSTAHL 18/10
INOX 18/10



TERMO HERMÉTICO
HERMETIC VACUUM



CLASSIC SATIN BOTELLA TERMO DOBLE PARED

double wall thermo bottle
bouteille thermo double paroi
doppelwandige thermoflasche
garrafa termos de parede dupla

Posibilidad de comprar surtido de botellas a partir de 2 unidades de cada para mínimo de 30 botellas en total.
Possibility of buying assortment from 2 units of each bottle, for a minimum of 30 bottles in total.



ref.	Lts.	Ø	H	📦	Bar Code
758435	0,350	7	21,5	2/6/24	8411922443028
758450	0,500	7	26	2/6/24	8411922443035
758475	0,775	8	30,5	2/6/24	8411922443042
758410	1,000	9	34	2/6/24	8411922452419

BOTELLA TERMO DOBLE PARED

double wall thermo bottle
bouteille thermo double paroi
doppelwandige thermoflasche
garrafa termos de parede dupla

ref.	Lts.	Ø	H	📦	Bar Code
758435R	0,350	7	22	2/6/24	8411922451153
758435V	0,350	7	22	2/6/24	8411922451139
758435P	0,350	7	22	2/6/24	8411922452471
758435B	0,350	7	22	2/6/24	8411922443059
758435F	0,350	7	22	2/6/24	8411922454284

GRANADA MUSGO MANGO DARK BLUE BLACK



GRANADA
MUSGO
MANGO
DARK BLUE
BLACK

MOSAIC LEMON ZIGZAG EVORA DOODLE SPRING LEMON



M. LEMON
ZIGZAG
EVORA
DOODLE
S. LEMON

ibili design

ref.	Lts.	Ø	H	📦	Bar Code
758435U	0,350	7	22	2/6/24	8411922452624
758435Z	0,350	7	22	2/6/24	8411922452587
758435E	0,350	7	22	2/6/24	8411922452631
758435K	0,350	7	22	2/6/24	8411922452570
758435N	0,350	7	22	2/6/24	8411922452617

ibili design

TROPIC OLATU ELBA ARLEQUIN LAGOS AVEIRO



TROPIC
OLATU
ELBA
ARLEQUIN
LAGOS
AVEIRO

ref.	Lts.	Ø	H	📦	Bar Code
758435A	0,350	7	22	2/6/24	8411922454260
7584350	0,350	7	22	2/6/24	8411922452563
758435C	0,350	7	22	2/6/24	8411922454277
758435D	0,350	7	22	2/6/24	8411922451177
758435G	0,350	7	22	2/6/24	8411922454291
758435H	0,350	7	22	2/6/24	8411922454307

BOTELLA TERMO DOBLE PARED

double wall thermo bottle
 bouteille thermo double paroi
 doppelwandige thermoflasche
 garrafa termos de parede dupla

ref.	Lts.	Ø	H	☐	Bar Code
758450R	0,500	7	26	2/6/24	8411922451160
758450V	0,500	7	26	2/6/24	8411922451146
758450B	0,500	7	26	2/6/24	8411922443066

GRANADA

MUSGO

DARK BLUE

GRANADA



MUSGO



DARK BLUE



loli design

ref.	Lts.	Ø	H	☐	Bar Code
758450P	0,500	7	26	2/6/24	8411922452488
758450D	0,500	7	26	2/6/24	8411922451184
758450J	0,500	7	26	2/6/24	8411922452716

MANGO

ARLEQUIN

SPRING BLUE

MANGO



ARLEQUIN



SPRING BLUE



loli design

ref.	Lts.	Ø	H	☐	Bar Code
758450W	0,500	7	26	2/6/24	8411922452648
758450T	0,500	7	26	2/6/24	8411922452662
758450G	0,500	7	26	2/6/24	8411922452723

LISBOA

PORTO

DROP

LISBOA



PORTO



DROP



loli design

ref.	Lts.	Ø	H	☐	Bar Code
758450A	0,500	7	26	2/6/24	8411922452655
758450H	0,500	7	26	2/6/24	8411922452709
758450M	0,500	7	26	2/6/24	8411922452693

ARROW

MARBLE

MOSAIC BLUE

ARROW



MARBLE



MOSAIC BLUE



loli design

ref.	Lts.	Ø	H	☐	Bar Code
7584500	0,500	7	26	2/6/24	8411922452679
758450I	0,500	7	26	2/6/24	8411922454161
758450S	0,500	7	26	2/6/24	8411922452686

OLATU

JAIA

SYMBOL BLUE

OLATU



JAIA



SYMBOL BLUE



BOTELLA TERMO DOBLE PARED

double wall thermo bottle
bouteille thermo double paroi
doppelwandige thermoflasche
garrafa termos de parede dupla

ibili design

ref.	Lts.	Ø	H	☐	Bar Code
758450AA	0,500	7	26	2/6/24	8411922454253
758450C	0,500	7	26	2/6/24	8411922454130
758450E	0,500	7	26	2/6/24	8411922454147

FARO
GOLDEN MARBLE
BLACK MARBLE

FARO



GOLDEN MARBLE



BLACK MARBLE



ibili design

ref.	Lts.	Ø	H	☐	Bar Code
758450F	0,500	7	26	2/6/24	8411922454154
758450K	0,500	7	26	2/6/24	8411922454178
758450L	0,500	7	26	2/6/24	8411922454185

FLORENCE
JARDIN
LILLE

FLORENCE



JARDIN



LILLE



ibili design

ref.	Lts.	Ø	H	☐	Bar Code
758450N	0,500	7	26	2/6/24	8411922454192
758450U	0,500	7	26	2/6/24	8411922454215
758450Z	0,500	7	26	2/6/24	8411922454246

PALMA
VENICE
BRIDGE

PALMA



VENICE



BRIDGE



ibili design

ref.	Lts.	Ø	H	☐	Bar Code
758450Q	0,500	7	26	2/6/24	8411922454208
758450Y	0,500	7	26	2/6/24	8411922454239
758450X	0,500	7	26	2/6/24	8411922454222

LIENZO
BAROQUE BLUE
BAROQUE BLACK

LIENZO



BAROQUE BLUE



BAROQUE BLACK



BOTELLA TERMO DOBLE PARED

double wall thermo bottle
 bouteille thermo double paroi
 doppelwandige thermoflasche
 garrafa termos de parede dupla



INOX /
S. STEEL
18/10



LUXE

ref.	Lts.	Ø	H		Bar Code
626305S	0,500	7,5	23	3/6	8411922453058

BOTELLA TERMO DOBLE PARED

double wall thermo bottle
 bouteille thermo double paroi
 doppelwandige thermoflasche
 garrafa termos de parede dupla



INOX /
S. STEEL
18/10



LUXE

ref.	Lts.	Ø	H		Bar Code
626307B	0,750	7,5	28,5	3/6	8411922453041

BOTELLA TERMO DOBLE PARED

double wall thermo bottle
 bouteille thermo double paroi
 doppelwandige thermoflasche
 garrafa termos de parede dupla

LEMON



ref.	Lts.	Ø	H		Bar Code
626206L	0,630	7,5	26	3/6	8411922453034



INOX /
S. STEEL
18/10



ibili design



ref.	Cms.	H		Bar Code
000907	65x65	190	1	8411922452860

VASO-TERMICO DOBLE PARED

vacuum mug
mug isotherme satin
thermobecher satin
caneca a vácuo satin

INOX /
S.STEEL

CLASSIC



ref.	Lts.	Ø	H	📦	Bar Code
758328	0,280	9	13	1/6/24	8411922442083
758341	0,410	9	17	1/6/24	8411922442090

VASO-TERMICO DOBLE PARED

vacuum mug
mug isotherme
thermobecher
caneca a vácuo

INOX /
S.STEEL

BLUEBERRY



ref.	Lts.	Ø	H	📦	Bar Code
758328B	0,280	9	13	1/6/24	8411922443004
758341B	0,410	9	17	1/6/24	8411922443011

VASO-TERMICO

vacuum mug
mug isotherme
thermobecher
caneca a vácuo



799904

799904 A

799904 R



ref.	Cms.	H	Lts.	📦	Bar Code
799904A	7	20	0,400	6/6	8411922441918
799904R	7	20	0,400	6/6	8411922441925
799904	7	20	0,400	6/6	8411922434583

VASO HERMÉTICO CLASS

vacuum mug
mug isotherme
tazza isothermica
caneca a vácuo



Doble pared térmica
Vacuum

Base con goma antideslizante
Bottom with anti-slip rubber

ref.	Ø	H.	Lts	📦	Bar Code
789904	7,5	19	0,390	1/6/24	8411922440089

VASO TÉRMICO DOBLE PARED

double-walled thermal cup
verre thermique à double paroi
bicchiere termico a doppia parete
copo térmico de parede dupla

INTERIOR PLÁSTICO
PLASTIC INSIDE

5 verde/green
4 morado/purple

±
2-4hrs



ref.	cms.	Lts	📦	Bar Code
736200	17,5x8	0,380	9/18	8411922090130

LATA THERMO

thermocan
cannette isotherme
thermo
termolata isotérmica



CLASSIC

ref.	Lts.	📦	Bar Code
796933I	0,330	6/24	8411922451214
796950I	0,500	6/24	8411922451221

BLUEBERRY

ref.	Lts.	📦	Bar Code
796933A	0,330	6/24	8411922451238
796950A	0,500	6/24	8411922451245

GRANADA

ref.	Lts.	📦	Bar Code
796933R	0,330	6/24	8411922451252
796950R	0,500	6/24	8411922451269

MANGO

ref.	Lts.	📦	Bar Code
796933P	0,330	6/24	8411922451276
796950P	0,500	6/24	8411922451283

MUSGO

ref.	Lts.	📦	Bar Code
796933V	0,330	6/24	8411922451290
796950V	0,500	6/24	8411922451306

ARLEQUIN

ref.	Lts.	📦	Bar Code
796933D	0,330	6/24	8411922451313
796950D	0,500	6/24	8411922451320

LATA THERMO ECO

thermocan eco
cannette isotherme eco
thermo eco
termolata isotérmica eco



ref.	lts.	📦	Bar Code
796900	0,330	6/24	8411922094084
796905	0,500	9/18	8411922435047

LATA THERMO BALL

thermocan ball
cannette isotherme ball
thermo ball
termolata isotérmica ball



ref.	lts.	📦	Bar Code
796950	0,330	6/24	8411922094091

Termos

ACERO INOXIDABLE 18/10
STAINLESS STEEL 18/10
INOX 18/10
EDELSTAHL 18/10
INOX 18/10



Doble pared
Double inner wall
Intérieure à double paroi
Doppia parete interna
Pared d'upla

TERMO PARA LIQUIDOS ROYAL

thermo for liquids
bouteille isotherme pour liquides
termo per liquidi
termo para líquidos

con asa
with hanger



12h
20h

ref.	Lts.	Ø	H	📦	Bar Code
758606	0,600	7,8	22,2	1/6	8411922451351
758609	0,900	9,0	23,6	1/6	8411922451368
758612	1,200	9,0	27,8	1/6	8411922451795

TERMO TRIP MINI

thermo for liquids
bouteille isotherme pour liquides
termo per liquidi
termo para líquidos

sistema de bloqueo
locking system

±
6-8hrs

botón de apertura
open button



ref.	Lts.	H	📦	Bar Code
765615	0,150	13,5	9/18	8411922451931

VASO DOBLE PARED PORTAYOGUR-CEREALES

double walled yoghurt and cereal cup
recipient double paroi pour yaourt et cereales
doppelwandiger becher für joghurt und cerealien
copa de parede dupla para iogurte e cereais

±
6-8hrs

NEW



ref.	Ø	Lts.	H	📦	Bar Code
687300	9	0,500	18	1/6	8411922459753

TERMO PARA LÍQUIDOS OFFICE

Thermo for liquids Office
Bouteille isotherme pour liquides Office
Thermoflasche Office
Termo para líquidos Office

±
12hrs



ref.	Lts.	H	📦	Bar Code
775035	0,350	12	9/18	8411922455663

TERMO LIQUIDOS COLORFUL

thermo for liquids
bouteille isotherme pour liquides
termo per liquidi
termo para líquidos

COLORFUL

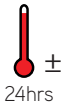

150ml



3 melocotón
3 azul
3 verde
3 rojo

500ml



3 peach
3 blue
3 green
3 red

ref.	Lts.	H	📦	Bar Code
753802C	0,150	17	12/24	8411922436266
753805C	0,500	25	12/24	8411922436273

TERMO PARA LÍQUIDOS MINI

thermo for liquids mini
bouteille isotherme pour liquides mini
termo per liquidi mini
termo para líquidos mini

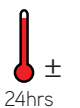

ref.	Lts	cms.	📦	Bar Code
753801	0,125	14x5	12/12	8411922088779
753802	0,150	17x5,5	12/24	8411922092622
753821	0,200	20,5x5,5	9/18	8411922436143

1 coffee
2 coffees
3 coffees

TERMO PARA LÍQUIDOS

thermo for liquids
bouteille isotherme pour liquides
thermo per liquidi
thermo para líquidos



ref.	lts.	📦	Bar Code
753803	0,350	1/6	8411922085907
753805	0,500	1/6	8411922085914
753807	0,750	1/6	8411922085921
753810	1,000	1/6	8411922085938
753812	1,200	1/6	8411922447989

TERMO PARA SÓLIDOS

thermo for solid food
bouteille isotherme pour aliments solides
thermo per solidi
thermo para sólidos



ref.	lts.	📦	Bar Code
753906	550	1/6	8411922085945
753908	800	1/6	8411922085952
753910	1.000	1/6	8411922085969

TERMO PARA SÓLIDOS CLASS

thermo for solid food class
bouteille isotherme pour aliments solides class
thermo per solidi class
thermo para sólidos class



ref.	Ø	lts.	H.	📦	Bar Code
741407	12,3	0,750	14	1/6/12	8411922435214
741410	12,3	1,00	16	1/6/12	8411922435221
741412	12,3	1,200	18,5	1/6	8411922439816

TERMO PARA LÍQUIDOS

thermo for liquids
bouteille isotherme pour liquides
thermo per liquidi
thermo para líquidos



loili design



Elegante diseño abombado
Elegant belly shape

ref.	Lts.	📦	Bar Code
745803	0,350	1/6/12	8411922436693
745805	0,500	1/6/12	8411922436709
745807	0,750	1/6/12	8411922436716
745810	1,000	1/6/12	8411922436723

TERMO PARA SÓLIDOS MINI

thermo for solid mini
thermo pour aliments solides mini
thermo per alimenti solidi mini
thermo para sólidos mini



loili design



ref.	lts.	📦	Bar Code
753903	0,300	9/9	8411922090616
753904	0,450	6/36	8411922093834

(1)

TERMO PARA SÓLIDOS

thermo for solid
thermo pour aliments solides
thermobehälter
thermo para sólidos

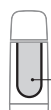

ref.	Lts.	∅	H	📦	Bar Code
758704	0,430	10	16	1/6	8411922452433
758706	0,620	10	19	1/6	8411922452440

JARRA TERMO

thermo jug
pitchet thermo
caraffa térmica
jarra termo



ref.	lts.	📦	Bar Code
748110	1	1/6	8411922437645
748115	1,5	1/6	8411922437652

TERMO
airpot

24h



ref.	Lts.	H.		Bar Code
741202	2,20	35	1/6	8411922435160
741203	3	39	1/6	8411922441734

TERMO PARA LÍQUIDOS

thermo for liquids
bouteille isotherme pour liquides
thermoflasche
termo para líquidos



XXL

XL

termo familiar
family size thermo



INOX /
S. STEEL
18/10

BPA

0h-110°C 8h-74°C 24h-48°C

ref.	Lts.	Ø	H		Bar Code
758814	1,400	10	32,5	1/6	8411922452457
758818	1,800	11	35	1/6	8411922452464



CEPILLO LIMPIADOR PARA TERMOS MINI

minithermo clining brush
brosse à laver mini thermo
spazzolino pulisci-mini-termos
escovilhão de limpeza mini termo



ref.	cms.		Bar Code
755726	26	12/120	8411922437812

CEPILLO LIMPIADOR - BOTELLAS

bottle cleaning brush
brosse à laver bouteilles
escovilhão de limpeza garrafa



ref.	cms.		Bar Code
755748	53	12/120	8411922068917

ESPONJA LIMPIADORA DE TERMOS-JARRAS-SIFONES

thermo bottle & jars cleaning sponge
éponge nettoyant thermo-jarres
esponja de limpeza para termos-jarros



ref.	cms.	Ø		Bar Code
764700	34	6 cms.	12	8411922205718



varios cocina mesa

kitchen- table

divers cuisine- table

Verschiedenes Küche/ Tisch

varios cozinha- mesa

ECO	239
Ceramic bowls	241
Kitchen aids	243
Ceramica	246
Borosilicato	248
Tritan	251
Ecozen	252
Lunch away	253
Premium	257
Cubiertos	259
Easycook	261
Healthy cooking	273
Japan	276
Oriente Medio	276
Mexico	277
Italia	280
Flexiform	282
Accesorios	284
Kitchen Aids	290
Organización	298
Salades	337
Flexiform	341
Madera	346
Intense	351
Soft	356
Nylon +	357
Nylon	357
Emma	358
Clásica	359
Supra	360
Prisma	361
Supreme	361
2000	362
Colorful	362
Kristall	363
Barware	366
Tapones	375
Tin Box	385
Niza	387
Biarritz	388
Dalvik	389
Hella	390
Camping	391
GastroDessin	393
Musgo	395
Cubos	397
Plato de huevos	398
Cuencos	399
Sena	400
Roja	400
Bordeaux	402
POP	407
Blanca	408
Versalles	414
Petrol	415
Expositor	416

CONSERVADOR PARA FRUTAS Y VERDURAS

Fruit and vegetable preserver
 Conservateur de fruits et légumes
 Obst- und gemüsekonservierer
 Conservador de frutas y verduras



MADE IN EU

+ fresco

libili design



- Conserva tus frutas y verduras frescas durante más tiempo, eliminando el gas de etileno de su entorno para ralentizar su maduración y envejecimiento.
 -Keep your fruit and vegetables fresh for longer by absorbing ethylene gas from the environment and slow down the ripening and ageing process.

KIT CARCASA + 4 SOBRES (6 MESES)
 KIT BOX + 4 SACHETS (6 MONTHS)
 KIT CARCASSE + 4 SACHETS (6 MOIS)
 SET BEHÄLTER + 4 BEUTEL (6 MONATE)
 KIT CARÇAÇA + 4 ENVELOPES (6 MESES)

ref.	Ø	H		Bar Code
699900	10	6	12	8411922456424



Incluye libro informativo
 Information leaflet included



Para nevera o frutero
 For fridge or fruit basket

RECAMBIOS / 8 SOBRES (12 MESES)
 REFILL / 8 SACHETS (12 MONTHS)
 PIÈCES DE RECHANGE / 8 SACHETS (12 MOIS)
 AUSTAUSCHE / 8 BEUTEL (12 MONATE)
 REPOSIÇÕES / 8 ENVELOPES (12 MESES)

ref.		Bar Code
699910	6	8411922456674



PLATO DE CAÑA DE AZUCAR

sugarcane plate
assiette canne à sucre
teller, zuckerrohr
prato de cana de açúcar

12 ud.

max. 190°C
min. -25°C



ref.	Ø	H	📦	Bar Code
260016	16	2	10/10	8411922452242
260020	20	2	10/10	8411922452259
260024	24	2	10/10	8411922452266

VASO ALMIDON DE MAIZ (BEBIDA FRÍA)

corn starch cup (cold drinks)
verre amidon de maïs compostable (boisson froide)
becher, maisstärke (kaltgetränke)
copo de amido de milho (para bebidas frias)

15 ud.

max. 40°C



ref.	ml.	Ø	H	📦	Bar Code
260402	220	7,5	9	10/20	8411922452334
260403	350	8	11	10/20	8411922452341
260405	500	9,5	13,5	10/20	8411922452358
260410	1000	11,5	15	10/20	8411922452365

(pack 10un.)

TENEDOR ALMIDÓN DE MAÍZ BLANCO

corn starch fork, white
fourchette amidon de maïs blanche
gabel, maisstärke, weiß
garfo de amido de milho, branco

6 ud.



ref.	Cms.	📦	Bar Code
260101	16,5	10/50	8411922452280

CUCHILLO ALMIDÓN DE MAÍZ BLANCO

corn starch knife, white
couteau amidon de maïs blanc
messer, maisstärke, weiß
faca de amido de milho, branco

6 ud.



ref.	Cms.	📦	Bar Code
260100	16,5	10/50	8411922452273

SURTIDO 4 COLORES PAJITAS DE PAPEL

assorted paper straws, 4 colours
assortiment 4 couleurs pailles en papier
papierhalme in vier verschiedenen farben
sortido de palhinhas de papel de 4 cores

48 ud.



ref.	Cms.	📦	Bar Code
260300	20	10/100	8411922452327

CUCHARA ALMIDÓN DE MAÍZ BLANCA

corn starch spoon, white
cuillère amidon de maïs blanche
esslöffel, maisstärke, weiß
colher de amido de milho, branco

6 ud.



ref.	Cms.		Bar Code
260102	16,5	10/50	8411922452297

CUCHARILLA ALMIDÓN DE MAÍZ BLANCA

corn starch teaspoon, white
petite cuillère amidon de maïs blanche
teelöffel, maisstärke, weiß
colher de amido de milho, branco

6 ud.



ref.	Cms.		Bar Code
260103	12,5	10/50	8411922452303



EXPOSITOR ECO

stand eco
exposant eco
stand eco
expositor eco

COMPOSICIÓN - COMPOSITION

Ref.	Desc.	Cantidad / Quantity
260300	Pajitas/Paper straws	20 packs de/of 48u.
260024	Platos/Plates 24cms	20 packs de/of 12u.
260020	Plato/Plates 20cms.	20 packs de/of 12u.
260102	Cuchara/Spoon	50 packs de/of 6un.
260016	Plato/Plates 16cms.	10 packs de/of 12un.
260100	Cuchillos/Knives	50 packs de/of 6un.
260202	Vaso/ Paper cup Kraft	10 packs de/of 12un.
260103	Cucharillas/Teaspoon	50 packs de/of 6un.
260402	Vaso/Cup 220ml	20 packs de/of 15un.
260403	Vaso/Cup 350ml	20 packs de/of 15un.
260405	Vaso/Cup 500ml	10 packs de/of 15un
260410	Vaso/Cup 1000ml	10 packs de/of 10un.
260101	Tenedor/Fork	50 packs de/of 6un.

opción expositor completo
Full display option



ref.	Cms.	H		Bar Code
000909	59x38	187	1	8411922453768

cartón
paperboard

Ceramic bowls

GRES ESMALTADO
GLAZED STOREWARE
GRÈS-ÉMAILLÉ
GRÈS-ÉMAILLÉ
GRÉS ESMALTADO

max. 250°C min. -20°C



CERAMIC

BOL

NEW

JARDIN WHITE



HEXAGON WHITE



LAMAY



OSTROV



HEBAO



HALSON



GOTLAND



TALAI



ACUARIO



REBUN



KUME



LOTO



ref.	Ø	H	Lts.	📦	Bar Code
687900	16	7,3	0,700	6/24	8411922460124
687901	16	7,3	0,700	6/24	8411922460131
687902	16	7,3	0,700	6/24	8411922460148
687903	16	7,3	0,700	6/24	8411922460155
687904	16	7,3	0,700	6/24	8411922460162
687905	16	7,3	0,700	6/24	8411922460179
687906	16	7,3	0,700	6/24	8411922460186
687907	16	7,3	0,700	6/24	8411922460193
687908	16	7,3	0,700	6/24	8411922460209
687909	16	7,3	0,700	6/24	8411922460216
687910	16	7,3	0,700	6/24	8411922460223
687911	16	7,3	0,700	6/24	8411922460230

JARDIN WHITE
HEXAGON WHITE
LAMAY
OSTROV
HEBAO
HALSON
GOTLAND
TALAI
ACUARIO
REBUN
KUME
LOTO



NEW



ALGARVE



COSTA NOVA



AVEIRO



HEXAGON RED



JARDIN BLUE



NAKURU



ELGON



ORMUZ



MENTHA



SAINT MALÓ



BIARRITZ



VENEZIA



ref.	Ø	H	Lts.	☐	Bar Code
688000	13,4	7,3	0,550	6/24	8411922460247
688001	13,4	7,3	0,550	6/24	8411922460254
688002	13,4	7,3	0,550	6/24	8411922460261
688003	13,4	7,3	0,550	6/24	8411922460278
688004	13,4	7,3	0,550	6/24	8411922460285
688005	13,4	7,3	0,550	6/24	8411922460292
688006	13,4	7,3	0,550	6/24	8411922460308
688007	13,4	7,3	0,550	6/24	8411922460315
688008	13,4	7,3	0,550	6/24	8411922460322
688009	13,4	7,3	0,550	6/24	8411922460339
688010	13,4	7,3	0,550	6/24	8411922460346
688011	13,4	7,3	0,550	6/24	8411922460353

- ALGARVE
- COSTA NOVA
- AVEIRO
- HEXAGON RED
- JARDIN BLUE
- NAKURU
- ELGON
- ORMUZ
- MENTHA
- SAINT MALÓ
- BIARRITZ
- VENEZIA

EXPO BOWLS

Capacidad
capacity
150 Bowls

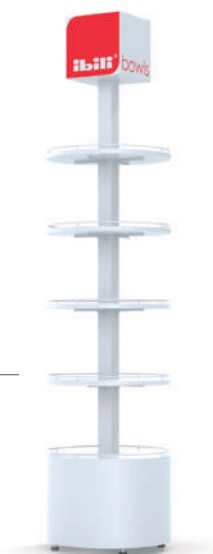

ref.	Ø	Cms.	☐	Bar Code
000988	40	170	1	8411922470338

Kitchen aids

TABLA PARA CORTE

Cutting board
Planche à découper
Schneidebrett
Tábua de corte

ULTRA RESISTENTE y DURADERA
VERY STRONG and DURABLE

MADE IN EU



Utilizable por ambas caras
Usable on both sides

ref.	Cms	H	📦	Bar Code
715429	29X19	6	4	8411922456868
715433	33X23	6	4	8411922456875
715437	37X27	6	4	8411922456882



Utilizable por ambos lados, un lado liso y el otro con canal.
Superficie de alta densidad que evita la absorción de líquidos.
Resistente a manchas o marcas de cuchillos.
Fibra de madera procedente de bosques gestionados de forma sostenible.
Usable on both sides. One side is smooth and the other side has grooves.
The surface is high density so liquids aren't absorbed.
Resists knife marks and stains.
Environmentally friendly cutting board made with wood fibre and natural resin from sustainably managed forests.

TABLA DE CORTE BLANCA

white cutting board
planche à découper blanche
tagliere bianca
tábua de corte branca



ibili design

PLASTIC HDPE

Muy estable gracias a sus 4 apoyos
Very stable thanks to its four feet
Resistente y a la vez suave con los cuchillos
Durable yet easy on knives
Utilizable por ambos lados
Can be used on both sides

ref.	cms.	📦	Bar Code
749430	30x20x1,5	4/12	8411922438376
749433	33x23x1,5	4/12	8411922438383
749438	38x28x1,5	4/8	8411922438390



Universal
Universal
Universel
Universale
Universal

TABLA DE CORTE VERDE

green cutting board
planche à découper vert
tagliere verde
tábua de corte verde



Verduras
Vegetables
Légumes
Verdure
Verduras

ref.	cms.	📦	Bar Code
749433V	33x23x1,5	4/12	8411922438413



TABLA DE CORTE AMARILLA

yellow cutting board
 planche à découper jaune
 tagliere giallo
 tábua de corte amarela



Aves
 Poultry
 Volaille
 Uccelli
 Aves

ref.	cms.		Bar Code
749433Y	33x23x1,5	4/12	8411922438437

TABLA DE CORTE AZUL

blue cutting board
 planche à découper bleu
 tagliere blu
 tábua de corte azul



Pescado
 Fish
 Poisson
 Pesce
 Piexes

ref.	cms.		Bar Code
749433A	33x23x1,5	4/12	8411922438406

TABLA DE CORTE ROJA

red cutting board
 planche à découper rouge
 tagliere rosso
 tábua de corte vermelha



Carnes
 Meats
 Viandes
 Carni
 Carnes

ref.	cms.		Bar Code
749433R	33x23x1,5	4/12	8411922438420

TABLA DE CORTE (surtido 8 piezas)

cutting board (assortment 8 pieces)
 planche à découper (assortiment 8 unités)
 taglieri (assortiti 8 pezzi)
 tábua de corte (sortimento 8 peças)

8 ud.



ref.	cms.		Bar Code
749400	33x23x1,5	8/32/96	8411922438444

CONTENEDOR PARA ALMACENAR CROQUETAS

container for croquettes
boîte à croquettes
kroketten-behälter
recipiente para corquetes



Con receta
With recipe
Avec recette
Con ricetta
Com receita

NEW

CONTENEDOR + 3 BANDEJAS APILABLES
CONTAINER + 3 STACKABLE TRAYS



45 ud.

8 cm



ref.	Cms.	H		Bar Code
686600	27x19	10,5	3/6	8411922459241

TAPER PARA EMBUTIDOS Y FIAMBRES

container for deli meats and cold cuts
récipient pour charcuterie
behälter für wurstwaren und aufschnitt
recipiente para embutidos y fiambres

NEW



ROJO/RED



AZUL/BLUE



ref.	Cms.	H		Bar Code
686710	24,8x14,4	3,30	6/36	8411922459500

ref.	Cms.	H		Bar Code
686720	24,8x14,4	3,30	6/36	8411922459517

AMARILLO/YELLOW



Surtido
assortment
assortiment
assortiti
sortimento



ref.	Cms.	H		Bar Code
686730	24,8x14,4	3,30	6/36	8411922459524

ref.	Cms.	H		Bar Code
686700	24,8x14,4	3,30	12/24	8411922459470

Ceramica

SALERO CUADRADO

salt cellar
salière
salzbehälter
saleiro

CERAMIC BAMBOO

lobi design



ref.	cms.	H.	Lts.	📦	Bar Code
714810	11x11	9,9	0,68	6/24	8411922448146

SALERO REDONDO

salt cellar
salière
salzbehälter
saleiro

CERAMIC BAMBOO

lobi design



ref.	cms.	H.	Lts.	📦	Bar Code
714805	10x12	11	0,75	6/24	8411922448139

SALERO/AZUCARERO CON CUCHARILLA

salt cellar / sugar bowl with spoon
salière / sucrier avec cuillère
salzbehälter / zuckerdose mit löffel
saleiro / açucareiro com colher

CERAMIC BAMBOO

lobi design



ref.	cms.	H.	Lts.	📦	Bar Code
714800	8,5x8,8	9	0,35	6/24	8411922448122

SALERO/AZUCARERO CON CUCHARILLA

salt cellar / sugar bowl with spoon
salière / sucrier avec cuillère
salzbehälter / zuckerdose mit löffel
saleiro / açucareiro com colher

CERAMIC ACRYLIC



ref.	Cms	📦	Bar Code
714860	8,7x8,7	6/36	84119224449686

SALERO CUADRADO

salt cellar square
salière carré
salzbehälter eskige
saleiro quadrado

CERAMIC ACRYLIC

tapa acrílica
acrylic lid



ref.	Cms	📦	Bar Code
714850	10,7x10,5	6/24	84119224448429

SALERO REDONDO

salt cellar round
salière rond
salzbehälter runde
saleiro redondo

CERAMIC ACRYLIC



ref.	Cms	📦	Bar Code
714855	11,3x10	6/24	8411922449310

SALERO DOBLE

double salt cellar
salière double
doppelter salzstreuer
saleiro duplo

lobi design

CERAMIC BAMBOO

sal fina / gruesa
fine / coarse salt



ref.	Cms	H	📦	Bar Code
714950	15,6x11	10	6/18	8411922449631

TARRO
jar
pot
einkochglas
frasco

ibili design



multusos
multipurpose

CERAMIC BAMBOO

ref.	Ø	Lts.	H	📦	Bar Code
715003	9,5	0,3	6,9	4/36	8411922449648
715005	11,5	0,5	7,9	4/24	8411922449655
715010	13,5	1,0	9,9	4/16	8411922449662

TARRO PARA AJOS

garlic jar
pot pour l'ail
knoblauchbecher
frasco para alhos

ibili design



CERAMIC BAMBOO

ref.	Ø	H	📦	Bar Code
715110	12	12	4/16	8411922449649

MANTEQUILLERA

butter dish
beurrer
butterdose
manteigueira

ibili design



CERAMIC

ref.	Cms	H	📦	Bar Code
714900	16,5X10	6	6/24	8411922449624

SALSERA

gravy boat
saucière
soßenschüssel
molheira



ref.	cms.	H.	Lts.	📦	Bar Code
715210	20,5x7	13	0,250	6/24	8411922451061

SET ACEITERA-VINAGRERA-SALERO-PIMENTERO-VINTAGE

vintage salt and pepper shaker set with oil and vinegar dispenser
set huilier, salière, poivrier vintage
essig-und ölgestell, saltzstreuer, pfefferstreuer vintage
conjunto de azeiteira, vinagreira, saleiro e pimenteiro vintage



ref.	Lts.	📦	Bar Code
715310	0,340	6	8411922451078

SET SALERO PIMENTERO VINTAGE

vintage salt and pepper shaker set
set salière, poivrier vintage
set salz-und pfefferstreuer vintage
conjunto de saleiro e pimenteiro vintage



ref.	cms.	H.	📦	Bar Code
715311	3,5x3,5	7,5	6/48	8411922451085

BOTELLA VINAGRE ALHAMBRA

vinegar bottle alhambra
bouteille vinaigre alhambra
essigflasche alhambra
garrafa vinagre alhambra



ref.	Ø	H.	Lts.	📦	Bar Code
715315	8	23,5	0,500	6/24	8411922451122

BOTELLA ACEITE ALHAMBRA

oil bottle alhambra
bouteille huile alhambra
öflasche alhambra
garrafa azeite alhambra



ref.	cms.	H.	Lts.	📦	Bar Code
715314	8	23,5	0,500	6/24	8411922451115

BOTELLA VINAGRE ANDALUS

vinegar bottle andalus
bouteille vinaigre andalus
essigflasche andalus
garrafa vinagre andalus



ref.	Ø	H.	Lts.	📦	Bar Code
715313	7,3	21	0,400	6/36	8411922451108

BOTELLA ACEITE ANDALUS

oil bottle andalus
bouteille huile andalus
öflasche andalus
garrafa azeite andalus



ref.	Ø	H.	Lts.	📦	Bar Code
715312	7,3	21	0,400	6/36	8411922451092

Borosilicato

max. 450°C min. -40°C 

RECTANGULAR

CONTENEDOR DE ALIMENTOS

food container
conteneur pour aliments
lebensmittelbehälter
recipiente para alimentos



Junta de silicona
silicone gasket

ref.	Cms	Lts.	H	📦	Bar Code
754704	15x10	0,400	5	4/24	8411922445084
754709	18,2x13,5	0,900	6,3	4/24	8411922445091
754710	19,5x14,5	1,050	7	4/24	8411922449426
754716	21,5x15,3	1,600	8,3	4/12	8411922445107

CUADRADO/SQUARE

CONTENEDOR DE ALIMENTOS

food container
conteneur pour aliments
lebensmittelbehälter
recipiente para alimentos



Junta de silicona
silicone gasket

ref.	Cms	Lts.	H	📦	Bar Code
754804	11,5x11,5	0,450	6,5	4/24	8411922445114
754807	14x14	0,750	7,2	4/24	8411922449433
754810	15x15	1,000	8	4/24	8411922445121

CONTENEDOR DE ALIMENTOS

food container
conteneur pour aliments
lebensmittelbehälter
recipiente para alimentos



REDONDO/
ROUND



ref.	Cms	Lts.	H	📦	Bar Code
755104	11,5	0,370	6,6	4/24	8411922452129
755106	14,7	0,610	7,3	4/24	8411922452136
755108	14,8	0,800	8,1	4/24	8411922452143

CONTENEDOR DE ALIMENTOS RECTANGULAR

food container
conteneur pour aliments
lebensmittelbehälter
recipiente para alimentos

+ALTO/TALLER

NEW



ref.	Cms	H	Lts.	📦	Bar Code
754709A	18x13	9,7	0,950	4/16	8411922459535

CONTENEDOR DE ALIMENTOS CUADRADO

food container
conteneur pour aliments
lebensmittelbehälter
recipiente para alimentos

+ALTO/TALLER

NEW



ref.	Cms	H	Lts.	📦	Bar Code
754810A	16x16	9,5	1,00	4/16	8411922459548

CONTENEDOR DE ALIMENTOS REDONDO

food container
conteneur pour aliments
lebensmittelbehälter
recipiente para alimentos

+ALTO/TALLER

NEW



ref.	Ø	H	Lts.	📦	Bar Code
755108A	10	9,8	0,800	4/16	8411922459552

CONTENEDOR DE ALIMENTOS AIR VENT

food container air vent
conteneur pour aliments air vent
lebensmittelbehälter air vent
recipiente para alimentos air vent

RECTANGULAR



ref.	Cms	Lts.	H	📦	Bar Code
757004	15,3x11,1	0,370	5,8	4/24	8411922452150
757006	17,6x13,1	0,650	6,5	4/24	8411922452167
757010	20,5x15,4	1,000	7,2	4/12	8411922452174
757015	22x16,4	1,500	6,6	4/12	8411922452181

CONTENEDOR DE ALIMENTOS AIR VENT

food container air vent
conteneur pour aliments air vent
lebensmittelbehälter air vent
recipiente para alimentos air vent

CUADRADO/SQUARE



ref.	Cms	Lts.	H	📦	Bar Code
757203	11,9	0,320	6,1	4/24	8411922452198
757205	13,7	0,520	6,8	4/24	8411922452204
757208	15,8	0,800	7,4	4/12	8411922452211
757212	18,5	1,200	7,5	4/12	8411922452228

CONTENEDOR DE ALIMENTOS MINI RECTANGULAR

food container mini
conteneur pour aliments mini
lebensmittelbehälter mini
recipiente para alimentos mini



ref.	Lts.	Cms.	H.	📦	Bar Code
754701	0,160	7x10	5	12/36	8411922452846

CONTENEDOR DE ALIMENTOS MINI REDONDO ROUND

food container mini
conteneur pour aliments mini
lebensmittelbehälter mini
recipiente para alimentos mini



ref.	Lts.	Ø	H.	📦	Bar Code
755101	0,130	8	5,5	12/36	8411922452853

CONTENEDOR DE ALIMENTOS

Food container
Conteneur pour aliments
Lebensmittelbehälter
Recipiente para alimentos

BAMBOO



ref.	Cms	Lts.	H	📦	Bar Code
685206	17,1x12,6	0,65	5,7	6/24	8411922458152
685210	19,9x15	1,00	6,4	6/12	8411922458169
685215	21,7x16,2	1,50	7,1	6/12	8411922458176

CONTENEDORES PARA ALIMENTOS 2 COMPARTIMENTOS

Food containers with two sections
Boîte alimentaire avec 2 compartiments
Lebensmittelbehälter mit 2 Fächern
Recipientes para alimentos com 2 compartimentos



ref.	Cms	Lts.	H	📦	Bar Code
754110	17,5x12,7	0,60	6	4/24	8411922457995
754120	20x15	0,95	6,9	4/12	8411922458008

SET 3 CONTENEDORES PARA ALIMENTOS

Set 3 Food containers
Set 3 Conteneurs pour aliments
Set 3 Lebensmittelbehälter
Set 3 Recipientes para alimentos



ref.	Lts.	📦	Bar Code
754750	0,180+0,650+1,500	6	8411922455878

SET 3 CONTENEDORES PARA ALIMENTOS

Set 3 Food containers
Set 3 Conteneurs pour aliments
Set 3 Lebensmittelbehälter
Set 3 Recipientes para alimentos



ref.	Cms	Lts.	H	📦	Bar Code
755150	11,6	0,220	5,6	6	8411922458367
	15,8	0,650	7,1		
	20,5	1,300	8,2		

Tritan



STRONG & RESISTANT / FUERTE Y RESISTENTE
 TRANSPARENT, LIGHT & STACKABLE / TRANSPARENTE, LIGERO Y APILABLE

Hermetic 100% / Hermético 100%
 Tritan BPA Free / Libre de BPA

CONTENEDOR HERMÉTICO TRITAN

hermetic food container
 conteneur hermétique
 hermetischer behälter
 recipiente hermetico

ref.	cms.	H.		Bar Code
790402	11x8,5	5	4/72	8411922447996



200 ml.



600 ml.

ref.	cms.	H.		Bar Code
790406	16x12	6,5	4	8411922440393



800 ml.

ref.	cms.	H.		Bar Code
790408	15,5x15,5	7	4/24	8411922447002



1000 ml.

ref.	cms.	H.		Bar Code
790410	16x12	11	4	8411922440409



1200 ml.

ref.	cms.	H.		Bar Code
790412	23x16	6,5	4	8411922440416



1500 ml.

ref.	cms.	H.		Bar Code
790415	15,5x15,5	10,5	4/16	8411922447019



2000 ml.

ref.	cms.	H.		Bar Code
790420	27x20	6,5	4	8411922440423



2300 ml.

ref.	cms.	H.		Bar Code
790423	23x16	11	4	8411922440430



3200 ml.

ref.	cms.	H.		Bar Code
790432	27x20	11	4	8411922440447

Ecozen



CONTENEDOR HERMÉTICO ECOZEN

hermetic food container
conteneur hermétique
hermetischer behälter
recipiente hermetico

Hermetic 100% / Hermético 100%
Ecozen BPA Free / Libre de BPA

STRONG & RESITANT / FUERTE Y RESISTENTE
TRANSPARENT, LIGHT & STACKABLE / TRANSPARENTE, LIGERO Y APILABLE

200 ml.



ref.	cms.	Lts.	H.	📦	Bar Code
790402E	11x8,5	0,200	5	4/72	8411922454024

800 ml.



ref.	cms.	Lts.	H.	📦	Bar Code
790408E	15,5x15,5	0,800	7	4/24	8411922454048

1000 ml.



ref.	cms.	Lts.	H.	📦	Bar Code
790410E	16x12	1,000	11	4	8411922454055

1200 ml.



ref.	cms.	Lts.	H.	📦	Bar Code
790412E	23x16	1,200	6,5	4	8411922454062

1500 ml.



ref.	cms.	Lts.	H.	📦	Bar Code
790415E	15,5x15,5	1,500	10,5	4/16	8411922454079

2000 ml.



ref.	cms.	Lts.	H.	📦	Bar Code
790420E	27x20	2,000	6,5	4	8411922454086

2300 ml.



ref.	cms.	Lts.	H.	📦	Bar Code
790423E	23x16	2,300	11	4	8411922454093

3200 ml.



ref.	cms.	Lts.	H.	📦	Bar Code
790432E	27x20	3,200	11	4	8411922454109

Lunch away

POLYESTER SILICONE PLASTIC 7 h.

PORTA-ALIMENTOS LUNCH AWAY + 2 CONTENEDORES GREEN

food carrier lunch away + 2 containers green
 porta-alimentos lunch away + 2 conteneurs green
 porta-alimenti lunch away + 2 contenitori green
 porta-alimentos lunch away + 2 recipientes green



ref.	Cms	H		Bar Code
753450	21x12	22	1/6	8411922438765

PORTA-ALIMENTOS LUNCH AWAY + 2 CONTENEDORES PEACH

food carrier lunch away + 2 containers peach
 porta-alimentos lunch away + 2 conteneurs peach
 porta-alimenti lunch away + 2 contenitori peach
 porta-alimentos lunch away + 2 recipientes peach

Separador de espacio para fruta, bebida o lácteos.
 Interior forrado con aislante térmico. 2 Bolsillos.
 Space divider for fruit, drinks or dairy products.
 Interior lined with thermal insulation. 2 pockets.



ref.	Cms	H		Bar Code
753455	21x12	22	1/6	8411922438772

PORTA-ALIMENTOS LITE AZUL + CONTENEDOR LITE AZUL

food carrier + container
 porte-aliments + conteneur
 trageetasche + behälter
 porta-alimentos + recipiente



ref.	cms.	Lts.	H.		Bar Code
753401A	21x13	3,75	14	1/6	8411922454567

PORTA-ALIMENTOS LITE GRIS

food carrier + container
 porte-aliments + conteneur
 trageetasche + behälter
 porta-alimentos + recipiente



ref.	cms.	Lts.	H.		Bar Code
753401G	21x13	3,75	14	1/6	8411922454574

SET 3 CUBIERTOS CON ESTUCHE LUNCH AWAY

3-piece cutlery set with case
set 3 couverts avec étui
set 3-teiliges besteck mit schachtel
conjunto de 3 talheres com estojo

INOX /
S. STEEL
18%

Tenedor / Fork 16 cms
Cuchara / Spoon 16cms
Cuchillo / Knife 18 cms

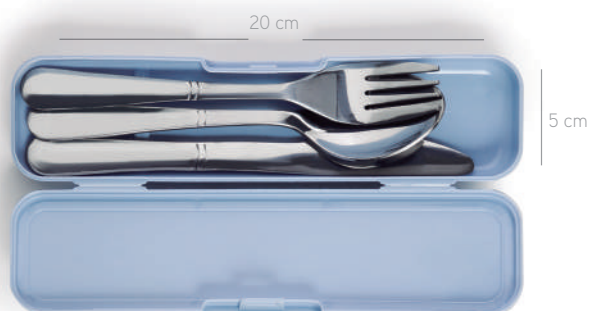

ref.		Bar Code
700600	12/96	8411922449242

FIAMBRERA TÉRMICA BLACK/GREEN

thermal lunch box
boîte alimentaire thermique
gedämmte brotbüchse
fiambreira térmica

1,4 L

2,2 L



PLASTIC

Doble pared
Doble wall



MELOCOTÓN/PEACH

ref.	Cms	Lts	H		Bar Code
728914P	20	1,4	15	2/12	8411922441703

VERDE/GREEN

ref.	Cms	Lts	H		Bar Code
728914G	20	1,4	15	2/12	8411922441697
728922G	20	2,2	19	2/12	8411922441710

DISPENSADORES DE ALIÑO

Condiment dispensers
Distributeurs de condiments
Gewürzspender
Dispensador de condimento

GLASS

PLASTIC



ref.	ml.		Bar Code
716250	10+50	6/36	8411922455304

BOTE HERMÉTICO SQUARE

stackable food saver
 contenant alimentaire empilable
 contenitore impilabile
 caixa empilhável

PLASTIC

ref.	Cms	H	Lts.		Bar Code
797105	9x9	10	0,5	6/24	8411922447170
797109	9x9	15	0,9	6/24	8411922447187
797112	9x9	20	1,2	6/24	8411922447194
797119	9x9	30	1,9	6/12	8411922447200



TARRO PARA ALIMENTOS

food container
 récipient pour aliments
 lebensmittelverpackung
 recipiente para alimentos

BOROSILICATE BAMBOO BPA max. 400°C



ref.	Lts.	Cms.	H.		Bar Code
681008	0,800	11x11	11	6/24	8411922454437
681011	1,100	11x11	15	6/24	8411922454444
681015	1,500	11x11	19	6/24	8411922454451



ENVASE DE VACÍO APILABLE

stackable vacuum food saver
 contenant alimentaire sous vide empilable
 contenitore per il sottovuoto impilabile
 caixa de vácuo empilhável

INOX / S. STEEL PLASTIC



(copyright)



ref.	ml.	cms		Bar Code
788710	1000	10,5x15,6x11,2	1/6	8411922089608
788720	2000	10,5x15,6x17,8	1/6	8411922089615
788736	3.600	10,5x15,6x29,0	1/6	8411922089622



ref.	ml.	cms		Bar Code
788604	400	10,5x10,5x9,6	1/6	8411922089561
788605	500	10,5x10,5x11	1/6	8411922089578
788619	1950	10,5x10,5x29	1/6	8411922089592

100%

PERFECTO VACÍO. HERMÉTICOS Y APILABLES
 VACUUM PACK. SEAL PROOF AND STOCKABLE
 VIDE PARFAIT. HERMÉTIQUES ET EMPILABLES
 PERFETTO SOTTOVUOTO. ERMITICI E IMPILIBILI
 VACUO PERFEITO. HERMÉTICOS E EMPILHÁVEIS

CONTENEDORES (EN DISPLAY BOX)

containers (display box)
conteneurs (boîte presentoir)
contenitori (scatola display)
recipientes (caixa display)

SILICONE PLASTIC



100%
HERMÉTICOS
AIRTIGHT



ref.	Cms	H	Lts.	📦	Bar Code
753406G	10x19	5	0,600	8/16	8411922439335
753408G	10x19	6,5	0,800	6/12	8411922439342
753406P	10x19	5	0,600	8/16	8411922439359
753408P	10x19	6,5	0,800	6/12	8411922439366

Green/verde (1)
Green/verde (2)
Peach/melocotón (3)
Peach/melocotón (4)

CONTENEDOR DE VIDRIO LUNCH AWAY

food container lunch away
conteneur pour aliments
contenitore per alimenti
recipiente para alimentos

BOROSILICATE



ref.	cm	Lts.	H.	📦	Bar Code
753385	19x13	0,850	7	6/12	8411922441024

CONTENEDOR PARA QUESO

cheese container
récipient à fromage
käsebehälter
recipiente para queijo

PLASTIC



libili design



ref.	Cms	H	📦	Bar Code
754510	27,5x22	6	14/84	8411922447101

PORTATORTILLAS

spanish omelette holder
boîte à tortilla
porta tortilla
porta-tortilhas

Con marcadores de porciones
Portion marking

PLASTIC



libili design

ref.	cm	📦	Bar Code
749110	22	6/12	8411922440461
749100	26	6/12	8411922438512

(1) verde / green
(2) melocotón / peach

Premium

CUCHILLOS
KNIVES
COUTEAUX
COLTELLI
FACAS

HOJA DE ACERO INOXIDABLE
MARTENSÍTICO, MANGO RESISTENTE
DE POLIOXIMETILENO (POM),
REMACHES DE ACERO INOXIDABLE

INOX 420 MoV + POM

High quality martensitic stainless steel blade, Polyoxymethylene handles (POM),
Stainless steel rivets.

Lame en acier inoxydable martensitique de grande qualité, Manche résistant en
polyoxyméthylène (POM), Rivets en acier inoxydable.

Lama in acciaio inox martensitico di alta qualità, Manico resistente in polioossimetilene (POM), Rivetti
in acciaio inox.

Folha de aço inoxidável martensítico de alta qualidade, Mango resistente de Polioximetileno (POM), Rebites
de aço inoxidável.



PVC
BOX

CUCHILLO MONDADOR

paring knife
couteau d'office
coltello speluchino
faca legumes



ref.	cms.		Bar Code
797300	7,5	6/36	8411922433067

CUCHILLO VERDURAS

vegetable knife
couteau d'office
coltello verdura
faca legumes



ref.	cms.		Bar Code
797301	10	6/36	8411922433074

CUCHILLO COCINA

kitchen knife
couteau à découper
coltello cucina
faca cozinha



ref.	cms.		Bar Code
797302	13	6/36	8411922433081

CUCHILLO COCINA

kitchen knife
couteau à découper
coltello cucina
faca cozinha



ref.	cms.		Bar Code
797303	15	6/36	8411922433098

CUCHILLO COCINA

kitchen knife
couteau à découper
coltello cucina
faca cozinha



ref.	cms.		Bar Code
797305	17	6/36	8411922433111

CUCHILLO COCINERO

chef's knife
couteau de cuisine
coltello cucina
faca chef



ref.	cms.		Bar Code
797304	17	6/36	8411922433104

CUCHILLO COCINERO

chef's knife
couteau de cuisine
coltello cucina
faca chef



ref.	cms.		Bar Code
797306	20	6/36	8411922433128

CUCHILLO JAMONERO

slicing knife
couteau à jambon
coltello prosciutto
faca de presunto



ref.	cms.		Bar Code
797310	25	6/36	8411922433135

CUCHILLO PANERO

bread knife
couteau à pain
coltello pane
faca pão



ref.	cms.		Bar Code
797311	20	6/36	8411922433142

CUCHILLO SANTOKU

santoku knife
couteau santoku
coltello santoku
faca santoku



ref.	cms.		Bar Code
797312	17	6/36	8411922433159

SOPORTE MAGNÉTICO PARA CUCHILLOS

magnet support for knives
support magnetique pour couteaux
barra magnetica per coltelli
suporte magnético de facas



INOX /
S. STEEL
PLASTIC

ref.	cms.		Bar Code
740438	38	6/36	8411922434811
740455	56	6/36	8411922434828

SOPORTE MAGNÉTICO PARA CUCHILLOS

magnet support for knives
support magnetique pour couteaux
barra magnetica per coltelli
suporte magnético de facas



INOX /
S. STEEL
MAGNETIC

ref.	cms.		Bar Code
748200	34	6/24	8411922437669

JUEGO DE 5 CUCHILLOS

set of 5 knives
set de 5 couteaux
5 messerset
conjunto de 5 facas

PLASTIC

INOX / S.STEEL

COLORFUL

Taco: madera
Block: wood



Cuchillo para pan

Bread knife
200 mm



Cuchillo de cocina
Kitchen knife
200 mm



Cuchillo cocinero
Chef's knife
200 mm



Cuchillo de cocina
Kitchen knife
125 mm



Cuchillo mondador
Paring knife
100 mm



ref.	cms.	H	📦	Bar Code
728310	8x7,5	35	1/6/12	8411922441673

JUEGO DE 5 CUCHILLOS

set of 5 knives
set de 5 couteaux
5 messerset
conjunto de 5 facas

PLASTIC

INOX / S.STEEL

CLASS

Taco: bambú
Block: bamboo



Cuchillo para pan
Bread knife
200 mm



Cuchillo de cocina
Kitchen knife
200 mm



Cuchillo cocinero
Chef's knife
200 mm



Cuchillo de cocina
Kitchen knife
125 mm



Cuchillo mondador
Paring knife
100 mm



ref.	cms.	H	📦	Bar Code
728320	14x10	34	1/3/6	8411922441680

Cubiertos

INOX / S.STEEL
2CR13



A



B



C

SET 6 TENEDORES MINI

Mini fork
Fourchette mini
Kleine gabel
Garfo mini

(A)

ref.	cms.	📦	Bar Code
680209	14,2	6/48	8411922449105

SET 6 CUCARILLAS MOKA

Mocha spoon
Petite cuillère moka
Mokkalöffel
Colher moka

(C)

ref.	cms.	📦	Bar Code
680203	11	6/48	8411922449044

Bister card



SET 6 CUCARILLAS DE CAFÉ

Coffee spoon
Petite cuillère à café
Kaffeelöffel
Colher de café

(B)

ref.	cms.	📦	Bar Code
680208	14	6/48	8411922449099



A



B



C



D



E



F



G

SET 3 TENEDORES DE MESA

Dinner fork
Fourchette de table (A)
Tafelgabel
Garfo de mesa

ref.	cms.	📦	Bar Code
680202	19,7	6/48	8411922449037

SET 3 CUCHILLOS DE MESA

Dinner knife
Couteau de table (B)
Tafelmesser
Faca de mesa

ref.	cms.	📦	Bar Code
680200	23	6/36	8411922449013

SET 3 CUCCHARAS DE MESA

Dinner spoon
Cuillère de table (C)
Tafellöffel
Colher de mesa

ref.	cms.	📦	Bar Code
680201	20	6/48	8411922449020

SET 3 TENEDORES DE POSTRE

Dessert fork
Fourchette à dessert (D)
Dessertgabel
Garfo de sobremesa

ref.	cms.	📦	Bar Code
680206	17,7	6/48	8411922449075

SET 3 CUCHILLOS DE POSTRE

Dessert knife
Couteau à dessert (E)
Dessertmesser
Faca de sobremesa

ref.	cms.	📦	Bar Code
680204	21	6/36	8411922449051

SET 3 CUCCHARAS DE POSTRE

Dessert spoon
Cuillère à dessert (F)
Dessertlöffel
Colher de sobremesa

ref.	cms.	📦	Bar Code
680205	17,8	6/48	8411922449068

SET 3 CUCHILLOS PARA CARNE

Steak knife
Couteau à viande (G)
Fleischmesser
Faca para carne

ref.	cms.	📦	Bar Code
680207	21	6/36	8411922449082

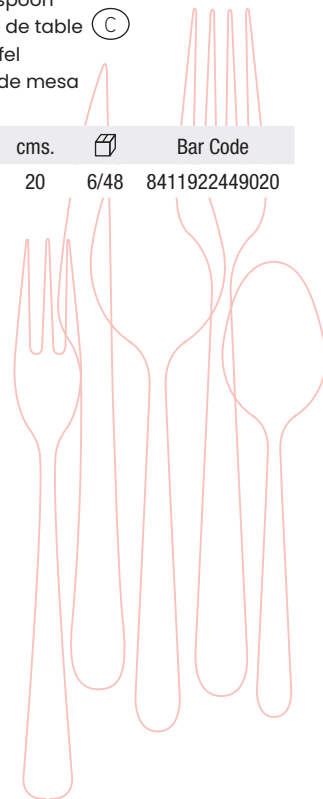

JUEGO 24 CUBIERTOS INOX

24 pieces cutlery set
set 24 couverts
besteckset 24-teilig
conjunto de 24 talheres



ref.	cms.	📦	Bar Code
680250	25x18	1/6	8411922452006



INOX/
S. STEEL
2CR13

Easycook

CORTAPATATAS PROFESIONAL

Potato cutter professional
Coupe frites professionnel
Pommesschneider mit schiebe-stempel professional
Cortador de batatas professional

INOX /
S. STEEL

2 medidas (9/12mm)
2 sizes (9/12mm)



con ventosa
with suction cup

ref.	cms.	H	📦	Bar Code
721010	25,5x12,5	10	1/6/12	8411922448955

RECAMBIOS CUCHILLAS CORTAPATATAS

Replacement blades
Grille de recharge
Ersatzklingen
Lâminas de substituição

INOX /
S. STEEL

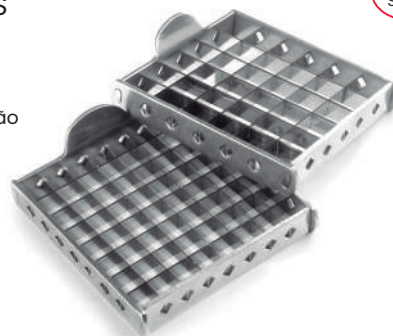

9mm

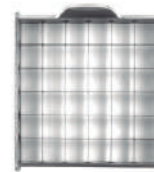

12mm

ref.	mm.	📦	Bar Code
721010R	9	1	8411922458329
721011R	12	1	8411922458732

CORTADOR EN ESPIRAL PROFESIONAL

Spiral slicer professional
Coupe-légumes en spirale professionnel
Spiralschneider professional
Cortador em espiral professional

INOX /
S. STEEL

espiral o espagueti
spiral or spaghetti



con ventosa
with suction cup

ref.	cms.	H	📦	Bar Code
721110	26x8	11	1/6/12	8411922448962

ABRIDOR DE LATAS Y TARROS EASYCOOK

can & jar opener
ouvre-boîtes/bocaux
apriscatole e barattoli
abridor de frascos e latas

INOX /
S. STEEL

PLASTIC



ref.	cms.	📦	Bar Code
743600	20x6	6/24	8411922436112

SACAPUNTAS TRIPLE

triple vegetable sharpener
taille-légumes triple
temperino per verdure triplo
afia-legumes triple

PLASTIC

INOX /
S. STEEL



ref.	cms.	∅	📦	Bar Code
745700	19	6,5	1/6/36	8411922436686

CORTAPATATAS PALANCA CLÁSICA

potato cutter
coupe frites
tagliapatate
cortador de batatas

PLASTIC

INOX /
S. STEEL



ref.	cms.		Bar Code
739100	25x9	6/24	8411922093544

PELADOR DE MANZANAS Y KIWIS

kiwi and apple peeler
éplucheur de pommes et de kiwis
sbucciatore per mele e kiwi
descascador de maçã e kiwi

PLASTIC

INOX /
S. STEEL

copyright



ref.	cms.		Bar Code
793900	15x7	1/6/24	8411922093452

MOLINILLO JULIANA

julienne mill
mouli julienne
julienne meccanico
mohino juliana

PLASTIC

INOX /
S. STEEL



8
discos
disks
disques
dischi
discos

Ø
12 cm



ref.	cms.		Bar Code
796400	30	1/6/36	8411922093766

CORTADOR DE LIMONES EN MEDIA LUNA

half-moon lemon slicer
coupe-citrons en quartiers
taglia limoni a mezzaluna
cortador de limões em meia-lua

PLASTIC

INOX /
S. STEEL

loli design

copyright

PROFESSIONAL



ref.	cms.	H		Bar Code
746800	17	16	1/6/12	8411922437157

MANDOLINA

kitchen grater
mandoline
mandolina

copyright



ref.	cms.		Bar Code
772400	30	1/6/12	8411922077568

MANDOLINA "V"

kitchen grater "V"
mandoline "V"
mandolina "V"

copyright



ref.	cms.		Bar Code
782000	31	1	8411922082814

MANDOLINA REGULABLE CON PUÑO

hand-held mandoline
mandoline manuelle
attetatrice manddina manuale
mandolina manual

copyright



ref.	cms.		Bar Code
789800	32	1/6	8411922090345

LAMINADOR DE AJOS

garlic slicer
lamineur ail
knoblauchhobel
laminador alhos

PLASTIC INOX / S. STEEL



ref.	cms.	H.		Bar Code
730210	23x6	4,5	6/96	8411922448177

PRENSA AJOS

garlic press
 presse-ail
 spremiaglio
 prensa-alhos

copyright



ref.	cms.		Bar Code
776400	19x4x6	1/6	8411922087765

CORTAPATATAS

easy food dicer
 coupe pommes de terre
 cortador de batatas

copyright



ref.	cms.		Bar Code
777800	24	1/6	8411922080384

PICADOR

chopper
 hachoir
 picador

copyright



ref.	cms.		Bar Code
772300	18	1/6	84411922077551

PICADOR PARA CARNE

Meat Grinder
 Hachoir à viande
 Fleischwolf
 Máquina de picar carne

Accesorio para embutidos
 Sausage making accessory



2 discos
 2 grinders



ref.	Cms.	H		Bar Code
777150	11	25	1/6/48	8411922456264

CORTADOR DE ENSALADILLA RUSA

olivier salad cutter
coupe salade russe
schneider für russischen salat
cortador de salada russa



-  Zanahorias
Carrots
-  Patatas
Potatoes
-  Aceitunas
Olives
-  Pepinillos
Pickles
-  Huevos
Eggs
-  Queso
Cheese



IBILI design
patent pending

Laminas o dados.
Para toda clase de verduras cocidas.
Slices or dice.
For all types of boiled vegetables.



- 1- Levanta los dos marcos y coloca el ingrediente cocido en la base.
 - 2- Baja un marco para realizar el primer corte
 - 3- Voltea el ingrediente
 - 4- Baja el segundo marco,
- *Para conseguir rodajas, utiliza solo el primer marco, y para conseguir bastones utiliza solo el segundo.

- 1- Lift the two frames and place the cooked ingredient in the base.
 - 2- Lower a frame to make the first cut.
 - 3- Turn the ingredient over.
 - 4- Lower the second frame.
- * To get slices, use only the first frame, and to get sticks use only the second.



Tus ensaladillas quedarán perfectas y ahorrarás mucho tiempo en su preparación.
Your salads will come out perfect and you'll save a lot of time making them

ref.	cms.	H		Bar Code
774710	21X12	3	1/6/24	8411922445077

MOLINILLO RALLADOR

revolving grater
moulin râpe
moinho ralador



copyright

ref.	cms.		Bar Code
772600	18	1/6	8411922077582

DESHUESADOR DE CEREZAS LAMINADOR DE FRESAS (2 EN 1)

Cherry Pitter / Strawberry slicer
Dénoyauteur de cerises / coupe fraises
Snocciolatore di ciliegie / affetta fragole
Descaroçador de cerejas / laminador de morangos

copyright

PLASTIC

INOX /
S.STEEL

2 funciones
2 functions
2 funzioni
2 funções



ref.	∅	H		Bar Code
793300	8	16,5	1/6/24	8411922092486

RALLADOR

grater
râpe
ralador

copyright



ref.	cms.		Bar Code
772500	15	1/6	8411922077575

RALLADOR DE QUESO GIRATORIO

rotary cheese grater
râpe à fromage tournante
grattugia rotante
ralador de queijo giratório

PLASTIC

INOX /
S.STEEL

también para chocolate
also for chocolate



ref.	cms.		Bar Code
739850	20x14x10	1/6/36	8411922439786

CORTADOR DE VERDURAS

vegetable slicer
coupeur à légumes
tagliaverdure
cortador de verduras

PLASTIC

INOX /
S. STEEL

Tiras y dados
strips and dices
lamelles et quarties
striscioline e dadi
tiras e dados

MEDIDAS DE
LAS CUCHILLAS

15x15
mm

10,7x10,7
mm

10,7x4,2
mm



ref.	cms.		Bar Code
741700	27x12	1/6	8411922435375

PICADOR RÁPIDO ROTATORY

quick chopper
hachoir rapide
schnellschneide
picador rápido

PLASTIC

INOX /
S. STEEL

Material de alta calidad
High quality material



3 cuchillas
3 blades



base antideslizante
non-slip base

ref.	Ø	H		Bar Code
750350	12,5	13	01/6/24	8411922452747

PICADOR DE PEREJIL

parsley mill
hachoir à persil
kräutermühle
moinho de picar salsa

NEW

INOX /
S. STEEL



ref.	cms.		Bar Code
688100	19x6	6/24	8411922470359

RALLADOR FINO

fine grater
râpe fine
ralador fino

verduras limón queso curado chocolate ajo jengibre	vegetables citrus zest hard cheese chocolate garlic ginger	légumes citron fromage endurci chocolat ail gingembre	verduras limão queijo curado chocolate alho gengibre
---	---	--	---

ref.	cms.	📦	Bar Code
779100	27x8	6/24	8411922081732



INOX / S. STEEL



Posición de depósito
Food container mode



RALLADOR GRUESO

coarse grater
râpe grosse
ralador grosso

verduras limón queso curado chocolate ajo jengibre	vegetables citrus zest hard cheese chocolate garlic ginger	légumes citron fromage endurci chocolat ail gingembre	verduras limão queijo curado chocolate alho gengibre
---	---	--	---

ref.	cms.	📦	Bar Code
779101	27x8	6/24	8411922081749



RALLADOR CLASS

grater
râpe
ralador



FINO

GRUESO

INOX / S. STEEL

ref.	cms.	📦	Bar Code
748400	32	6/60	8411922437690
748401	32	6/60	8411922437706

fino
grueso

RALLADOR LARGO CLASS

long grater
râpe étroit
ralador longo



FINO

GRUESO

INOX / S. STEEL

ref.	cms.	📦	Bar Code
748450	40	6/60	8411922437713
748451	40	6/60	8411922437720

fino
grueso

RALLADOR 4 CARAS

Grater 4 sides
Râpe 4 faces
4-Seitiger küchenreibe
Raspador 4 caras

XL



INOX / S. STEEL

ref.	Cms	📦	Bar Code
682000	10,5x7,5	6/12	8411922455618

RALLADOR PLANO

Flat grater
Râpe plate
Flache reibe
Ralador plan



INOX / S. STEEL

PLASTIC

ref.	Cms	📦	Bar Code
681300	24x11	6/72	8411922455502

RALLADOR PLANO

flat grater
râpe plate
flache reibe
ralador plan



INOX /
S. STEEL

FINO Y GRUESO
FINE & COARSE

ref.	cms.		Bar Code
680900	28x11,5	6	8411922454420

MINIRALLADOR 4 CARAS MINI

minigrater 4 sides
minirâpe 4 faces
miniraspador 4 caras

INOX /
S. STEEL



ref.	H.		Bar Code
705300	7	6/84	8411922072617

RALLADOR 4 CARAS

grater 4 sides
râpe 4 faces
raspador 4 caras

INOX /
S. STEEL



ref.	H.		Bar Code
756600	20	6/144	8411922209259

RALLADOR NUEZ MOSCADA

nutmeg grater
râpe pour noix de muscade
ralador de noz moscada

INOX /
S. STEEL



ref.	cms.		Bar Code
750600	13,5	6/144	8411922069952

RALLADOR 4 CARAS MINI

grater 4 sides mini
râpe 4 faces mini
raspador 4 caras mini

INOX /
S. STEEL



ref.	H.	Cms.		Bar Code
756650	8	3,5x3	6/72	8411922435184

RALLADOR DE COL

cabbage grater
râpe à chou
kohlreibe
ralador para couves

INOX /
S. STEEL



ref.	cms.		Bar Code
748410	13	6/60	8411922441932

TIJERA CLÁSICA (SURTIDO DE COLORES)

kitchen scissors
ciseaux de cuisine
forbici
tesoura de cozinha



ref.	Cms		Bar Code
704904C	22	24/48	8411922440584

TIJERAS CON FUNDA MAGNÉTICA

scissors with a magnetic holder
ciseaux avec étui magnétique
schere mit magnetetui
tesoura com bainha magnética

INOX /
S. STEEL



ref.	Cms		Bar Code
704911	22	6/36	8411922447149

TIJERAS DE COCINA

kitchen scissors
ciseaux de cuisine
tesoura de cozinha



INOX /
S. STEEL



ref.	cms.		Bar Code
704904	22	6/36	8411922081800

TIJERAS PARA HIERBAS

herb scissors
ciseaux de herbes
tesoura para ervas



INOX /
S. STEEL



Multi-hojas
Multi-blades
Multi-lames
Multi-folhas

ref.	cms.		Bar Code
704903	22	6/36	8411922081794

TIJERAS PARA AVES

poultry scissors
ciseau à volaille
tesoura para aves



INOX /
S. STEEL



ref.	cms.		Bar Code
704905	25	1/6	8411922083255

TIJERAS LUXE

scissors luxe
ciseaux luxe
forbici luxe
tesouras luxe



INOX /
S. STEEL

Extrafuerte
Extra-strong



ref.	Cms		Bar Code
704909	23	6/36	8411922433760

TIJERAS PARA HUEVO DE CODORNIZ

quail eggs scissors
ciseaux pour oeufs de caille
forbici per uova di quaglia
tesoura para ovos de codorniz



INOX /
S. STEEL

ref.	cms.		Bar Code
768200	14x6	12/144	8411922441062

TIJERA PELAGAMBAS

prawn-peeling scissors
ciseaux épluche-crevettes
tesoura para descascar camarões



INOX /
S. STEEL



ref.	cms.		Bar Code
704906	18	6/120	8411922086850

TIJERA MULTIUSO

scissors multi-use
ciseaux multi-usages
schere mehrzweck
tesouras multiusos



INOX /
S. STEEL

ref.	cms.		Bar Code
705210	18,5X8	6/36	8411922441581

TIJERA PARA TRINCHAR AVES PROFESIONAL

professional poultry shears
ciseaux à volaille professionnels
professionelle geflügelschere
tesoura para trinchar aves professional



INOX /
S. STEEL

cierre de seguridad
easy-opening safety lock

ref.	cms.		Bar Code
704913	25,5	6/36	8411922448603

TIJERA DUO (Tabla + Cuchillo)

clever cutter (cutting board and knife)
ciseau duo (planche + couteau)
forbide duo (tagliere + coltello)
tesoura duo (tábua + faca)



cierre de seguridad
safety lock



INOX /
S. STEEL

PLASTIC

NO FOR USA



ref.	Cms		Bar Code
704910	25	6/36	8411922440003

TIJERA PARA HUEVO HERVIDO

egg scissors
ciseaux pour œufs
tesoura para ovos
eierköpfer



INOX /
S. STEEL

ref.	Ø		Bar Code
704912	8	6/36	8411922448306

SOPORTE PARA HUEVO HERVIDO

boiled egg cup
coquetier
eierhalter
suportes para ovo cozido



2 ud.

INOX /
S. STEEL

ref.	Ø	H		Bar Code
764650	5	4,5	6/108	8411922453393

CUCHILLO PARA TOMATE

tomato knife
couteau à tomate
coltello per pomodoro
faca de tomate

ibili design



INOX / S. STEEL

& ANTIADHERENTE NON STICK
DISPLAY BOX

CUCHILLO PARA PAN

bread knife
couteau a pain
coltello per pane
faca de pão

ibili design



ref.	cms.	📦	Bar Code
726200	22	24/48	8411922083545

ref.	cms.	📦	Bar Code
726210	26	15/48	8411922439953

CUCHILLO DE COCINA MULTIUSO

multiuse kitchen knife
couteau de cuisine multifonction
coltello cucina multiuso
faca de cocinina multiusos



ref.	cms.	📦	Bar Code
(1) 727608P	8,5	24/48	8411922088854
727612P	12,5	6/72	8411922088878

SOPORTE PARA CUCHILLOS Y TIJERAS

Support for knives and scissors
Support pour couteaux et ciseaux
Supporto per forbici e coltelli
Suporte para facas e tesouras

PLASTIC

POLYSTYRENE



ref.	H	Ø	📦	Bar Code
799000	22	11	1/8	8411922434088

CUCHILLO DE COCINA MULTIUSO

multiuse kitchen knife
couteau de cuisine multifonction
coltello cucina multiuso
faca de cocinina multiusos



verde/green

ref.	cms.	📦	Bar Code
(1) 727608	8,5	24/48	8411922084795
727612	12,5	6/72	8411922088861
727615	15	6/72	8411922088885
(2) 727650	8,5+12,5+15	6/36	8411922088908



INOX / S. STEEL

& ANTIADHERENTE NON STICK

CUCHILLO MULTIUSO CON FUNDA

multi-purpose knife with case
couteau multi-usage avec étui
coltello multifunzionale con custodia
faca multifunções con capa



24 units

INOX / S. STEEL

& ANTIADHERENTE NON STICK

ref.	Cms	📦	Bar Code
797500	20	24/96	8411922439281



CUCHILLO MONDADOR BASIC

paring knife
couteau d'office
schälmesser
faca legumes

ibili design

con protector
with protection

INOX /
S. STEEL
3CR13

PLASTIC



ref.	H	📦	Bar Code
680700	20	24	8411922454406

CUCHILLO MONDADOR BASIC COLORFUL

Paring knife Colorful
Couteau d'office Colorful
Schälmesser Colorful
Faca legumes Colorful



INOX /
S. STEEL

PLASTIC

ref.	cms.	📦	Bar Code
680700C	20	24/144	8411922458749

Healthy cooking

RECIPIENTE DE VAPOR H-CLASS

steam case
coffret vapeur
astuccio per la cottura a vapore
recipiente para cozinhar a vapor

ibili design



Con recetas
With recipes



+ Esterilla/Bandeja
Mat/Tray



Explora las oportunidades que ofrece la cocina con microondas con el recipiente de vapor IBILI
Explore the opportunities that microwave cooking offers with IBILI's steam case.

ref.	Cms	H	Its.	📦	Bar Code
873200	17x25	10	1,0	1/6	8411922440058



RECIPIENTE DE VAPOR

steamer

cuisneur vapeur

cuoci vapore

estojo para cozedura

Copyright
T



RECETARIO INCLUIDO
cook leaflet included
livret de recettes inclus
ricettario incluso
receituário incluído



ref.	cms.	lts.		Bar Code
870424	15x24x5	1,0	1/6	8411922083705

RECIPIENTE DE VAPOR

steamer

cuisneur vapeur

cuoci vapore

estojo para cozedura



ref.	cms.	lts.		Bar Code
870428	21x28x8	2,5	1/6	8411922084221

ESCALFADOR DE HUEVOS PARA MICROONDAS

microwave egg poacher

pocheuse à oeufs pour micro-ondes

eierpochierer für die mikrowelle

escalfador de ovos para micro-ondas

PLASTIC



TIEMPOS DE COCCIÓN ORIENTATIVOS

suggested cooking times

temps de cuisson indicatifs

ungefähre kochzeit

tempos de cocção orientativos

		900W
45s - 50s	1min 20s - 1min 25s	Yema blanda Soft Yolk Jaune mou Weich Gema líquida
60s - 65s	1min 50s - 1min 55s	Yema dura Hard Yolk Jaune dur Hart Gema dura

* Añadir/reducir 5-10s por cada 100W menos/más de potencia.

* Add/subtract 5-10s for each 100W less/more of power.

* Ajouter ou supprimer 5-10 s tous les 100W de puissance en moins ou en plus.

* Je 100 Watt mehr/weniger Leistung 5-10 Sek. mehr/weniger Kochzeit.

* Acrescentar/reduzir 5-10 segundos por cada 100W menos/mais de potência.

ref.	Cms.	H		Bar Code
730610	22x11	8	1/6	8411922448245

KIT PARA FIAMBRE ARTESANO (MICROONDAS)

traditional cold meats kit (microwave)
kit pour charcuterie artisanale
kit per la preparazione artigianale di insaccati
kit para fiambre artesanal



RECETARIO INCLUIDO
cook leaflet included
livret de recettes inclus
ricettario incluso
receituário incluído

LFGB

GLASS

SILICONE

Para aprox. 350 gr de fiambre
For around 350 gr of cold meat

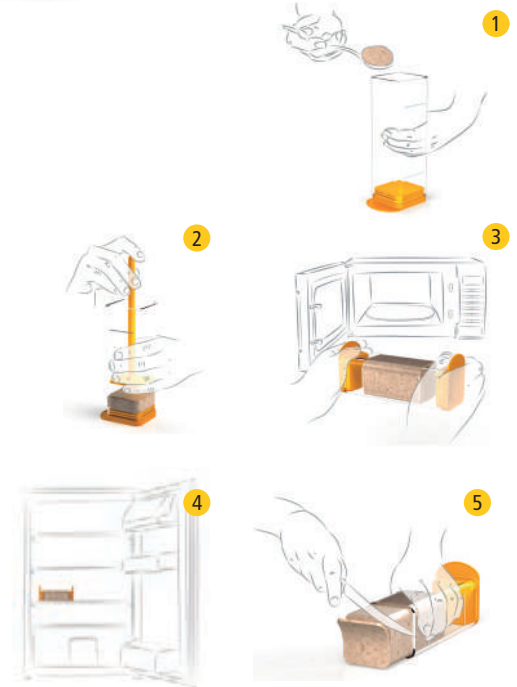

ref.	cms.	H		Bar Code
746700	19	6x6	1/6/36	8411922437140

KIT PARA 12 BARRITAS ENERGÉTICAS CASERAS

homemade 12 power bar kit
kit pour 12 barres énergétiques artisanale
kit per 12 barrette energetiche artigianale
kit para 12 barras energéticas artesanales



LFGB

SILICONE

Molde + 2 Estuches
Mould + 2 cases

RECETARIO INCLUIDO
cook leaflet included
livret de recettes inclus
ricettario incluso
receituário incluído



ref.	cms.	H		Bar Code
747000	15	7	5	8411922437423
747001	15	7	5	8411922438277

- ① melocotón / peach
- ② verde / green

Japan

PLASTIC



MOLDE PARA SUSHI

sushi maker
moule à sushi
molde para sushi



ref.	cms.		Bar Code
773800	22	1/6	8411922078954

MOLDE PARA SUSHI "ONIGIRI"

"onigiri" sushi maker
moule à sushi "onigiri"
molde para sushi "onigiri"

Con receta
With recipe
Avec recette
Con ricetta
Com receita



ref.	cms.		Bar Code
773810	12x12	1/6	8411922084870

MOLDE PARA SUSHI "GUNKAN"

"gunkan" sushi maker
moule à sushi "gunkan"
molde para sushi "gunkan"

Con receta
With recipe
Avec recette
Con ricetta
Com receita



ref.	cms.		Bar Code
773820	19x7	1/6	8411922084887

Oriente Medio

MOLDE FALAFEL

falafel mould
moule à falafel
falafel-form
molde para falafel

Con receta
With recipe
Avec recette
Con ricetta
Com receita



INOX /
S. STEEL



ref.	Ø	Cms.		Bar Code
705710	4	14	6/96	8411922449570
705706	6	14	6/72	8411922457131

Falafel: Croqueta a base de garbanzos ó habas muy popular en Oriente Medio.
Falafel: Deep-fried flat ball made from chickpeas or fava beans, very popular in Middle East.

Mexico

ALUMINIO FUNDIDO
CAST ALUMINIUM
ALUMINIUM EN FONTE
ALLUMINIO FUSO
ALUMINIO FUNDIDO

PRENSA TORTILLAS

tortilla press
appareil pour tortillas
pressa per tortillas
utensilio para tortilhas



ref.	cms.		Bar Code
799820	20	1/6	8411922434576

SOPORTE INOX PARA TACOS

taco holder
support pour tacos
taco halter ständer
suporte para tacos

PARA 2-3 TACOS
FOR 2-3 TACOS

INOX /
S. STEEL

NEW



ref.	cms.	H		Bar Code
687600	21,3x10	5,5	6/72	8411922459845

TORTILLERO

tortilla warmer
chauffe-tortillas
tortillakorb
recipiente para tortilhas

Mantiene las tortillas mexicanas
de maíz o de trigo calientes
Keeps corn or wheat Mexican tortillas hot

PLASTIC

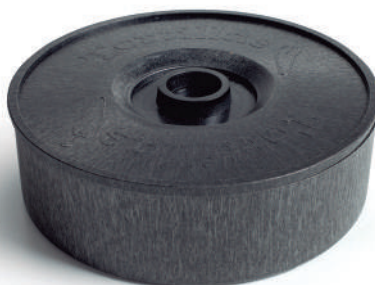

ref.	Cms	H.		Bar Code
794117	17,5	3,8	6	8411922453669
794122	22	7,0	6	8411922453676

CORTADOR PARA RAVIOLI REDONDO

round ravioli cutter
coupe-raviolis rond
ravioli-ausstecher rund
cortador de ravioli redondo

INOX / S. STEEL MADERA DE CAUCHO RUBBER WOOD



ref.	Ø	📦	Bar Code
684100	6	6/120	8411922457353

CORTADOR PARA RAVIOLI CUADRADO

square ravioli cutter
coupe-raviolis carré
ravioli-ausstecher quadratisch
cortador de ravioli cuadrado

INOX / S. STEEL MADERA DE CAUCHO RUBBER WOOD



ref.	cms.	📦	Bar Code
684110	6x6	6/120	8411922457360

CORTADOR PARA RAVIOLI DOBLE

double ravioli cutter
coupe-raviolis double
doppelter ravioli-ausstecher
cortador de ravioli duplo

INOX / S. STEEL MADERA DE CAUCHO RUBBER WOOD



ref.	cms.	📦	Bar Code
684120	20	6/144	8411922457377

CORTADOR DE RAVIOLIS CUADRADO (BLISTER)

square raviolis cutter
coupe-pâte ravioli carré
cortamassas raviolis cuadrado

INOX / S. STEEL 18%



ref.	Cms.	📦	Bar Code
779400	6x6	6/144	8411922081879

CORTADOR DE RAVIOLIS REDONDO (BLISTER)

round raviolis cutter
coupe-pâte ravioli rond
cortamassas raviolis redondo

INOX / S. STEEL 18%



ref.	Cms.	📦	Bar Code
779401	6	6/144	8411922081886

MOLDE RAVIOLI CUADRADO + RODILLO

SQUARE ravioli mould + Rolling pin
 Moule raviolis CARRÉ + Rouleau
 Ravioliform RECHTECKIG + Rolle
 Molde ravioli QUADRADO + Rolo

ibili design

PLASTIC



ref.	cms.	H		Bar Code
683000	30x12	2,2	3/6	8411922456653



MOLDE RAVIOLI REDONDO + RODILLO

ROUND ravioli mould + rolling pin
 Moule raviolis ROND + rouleau
 Ravioliform RUND + Rolle
 Molde ravioli REDONDO + rolo

ibili design

PLASTIC



ref.	cms.	H		Bar Code
683050	30x12	2,2	3/6	8411922456660

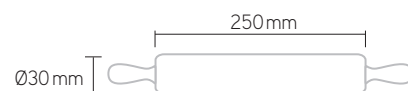

Italia

MAQUINA DE PASTA

pasta machine
machine à pâte
máquina de pasta



ESPESOR DE PASTA

0,2 - 3 mm

ref.	cms.		Bar Code
773100	17	1/6	8411922078053

ACCESORIO PARA RAVIOLI

ravioli attachment
accessoire à ravioli
accesório para ravioli



ESPESOR DE PASTA

0,2 - 3 mm

ref.	cms.		Bar Code
725404	16x8	1/12	8411922082227



(Solo el accesorio, no incluye la máquina principal)
(Only the accesory, Main machine not included)

MEDIDOR DE ESPAGUETTIS

spaguetti measurer
mesure à spaguetti
medidor para esparguete



INOX /
S. STEEL

ref.	cms.		Bar Code
774200	16,5	12/240	8411922079470

SECADOR PARA PASTA FRESCA DESMONTABLE

Collapsible fresh pasta drying rack
Séchoir à pâtes fraîches démontable
Pastatrockner, zerlegbar
Secador desmontável para massa fresca

MADERA
DE PINO

PINE
WOOD

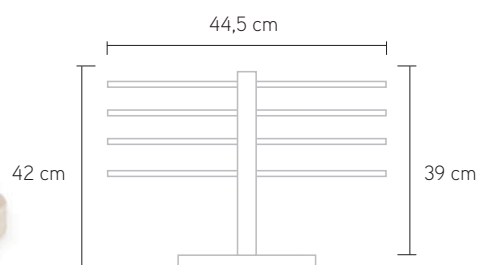

ref.	cms.	H		Bar Code
683900	44,5	42	6	8411922457285

TABLA PARA GNOCCHI/GARGANELLI + PALO PARA MOLDEAR

Gnocchi/garganelli board + rolling pin
 Planche à gnocchi/garganelli et rouleau
 Gnocchi/Garganelli Holzbrett
 Tábua para gnocchi/garganelli e pan para moldar

MADERA DE PINO+CIPRES
 PINE+CYPRESS WOOD



ref.	cms.		Bar Code
683600	20x6,5	6/96	8411922457032

GRILL PIEDRA REDONDO

Round stone grill
 Grill pierre rond
 Heißer Stein rund
 Grelhador pedra redonde

INOX / S. STEEL

PIEDRA / STONE

PIEDRA

Stone
 Pierre
 Stein
 Pedra

PIEDRA / STONE



ref.	Ø	H		Bar Code
755050	30	1,8	1/2	8411922455489

ref.	Ø	H		Bar Code
755050P	30	1,8	1/3	8411922455922

GRILL PIEDRA RECTANGULAR

stone grill
 grill pierre
 grill pietra
 grelhador pedra



ref.	cms.		Bar Code
755000	18x37	1/4	8411922087291
755000P	18x37	1/3	8411922093957

(1)

(1) REPUESTO PIEDRA

stone spare
 pierre
 pietra
 pedra

Flexiform



max.
300°C



LFGB

SILICONE

BPA

TAPA ANTIDERRAME

splatter guard
protection anti-éclaboussure
coperchio antifuoriuscita
tampa antiderrame



Ø14-24 cm



copyright



-Evite el rebosamiento por ebullición
-Stops over boiling

ref.	Cms	📦	Bar Code
749727	29	1/5/25	8411922438802

TAPA DE SILICONA

silicone lid
couvercle en silicone
coperchio in silicone
tampa de silicone



max.
220°C



min.
-20°C

LFGB

SILICONE



ref.	Ø	📦	Bar Code
744400	27,5	6/24	8411922436457

TAPA PARA MICROONDAS PLEGABLE

foldable microwave cover
couvercle pliable pour micro-ondes
coperchio pieghevole per microonde
tampa dobrável para microondas



bili design



SILICONE

ref.	Ø	H	📦	Bar Code
798500	25,5	8,5	6/6	8411922433968

Plegable, 2 posiciones · Guardado fácil
Foldable, 2 positions · Easy storage

PICO VERTEDOR ADAPTABLE

slip-on pot spout
bec verseur amovible
beccuccio versatore adattabile
bico vertedor adaptável

LFGB

SILICONE

max. 230°C
min. -60°C

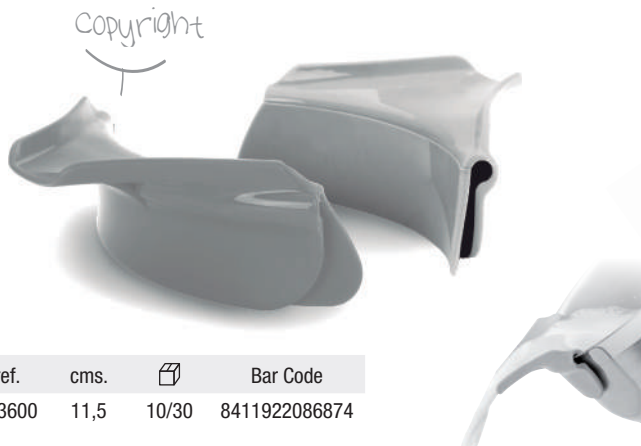

ref.	cms.	📦	Bar Code
733600	11,5	10/30	8411922086874

ESPUMADERA PARA FONDUE

fondue skimmer
écumoire à fondue
schaumlöffel für fondue
escumadeira para fondue

INOX / S. STEEL



ref.	Cms.	∅	📦	Bar Code
725610	23	6	12/96	8411922449112

TEMPORIZADOR DE COCINA DIGITAL

digital kitchen timer
minuterie de cuisine digitale
digitaler küchentimer
temporizador de cozinha digital

PLASTIC



No incluye pilas
Batteries no included

con imán
with magnet

ref.	Cms	📦	Bar Code
743407	7X7	6/72	8411922441833

TEMPORIZADOR DE COCINA DIGITAL

Digital kitchen timer
Minuterie de cuisine digitale
Digitaler küchentimer
Temporizador de cozinha digital

INOX / S. STEEL



No incluida
Not included

con imán
with magnet

ref.	Cms.	📦	Bar Code
743411	7x6,4	6/72	8411922456271

TEMPORIZADOR DE COCINA

kitchen timer
minuterie de cuisine
küchentimer
temporizador de cozinha

INOX / S. STEEL



ref.	cms.	📦	Bar Code
743408	6X6	6/72	8411922441840

PLACA PARA DESCONGELAR ALIMENTOS

Plate for defrosting food
Plaque pour décongeler des aliments
Auftauplatte für Gefriergut
Placa para descongelar alimentos

SILICONE

ALUMINIUM

PLASTIC

Aluminium

Plastic

Silicone

-Reduce el tiempo de de descongelación
Reduces defrosting time
-Bandeja para recoger el agua
Lower tray to collect the water



ref.	Cms	📦	Bar Code
724450	23,5x33,5	6	8411922455373

Accesorios

ELIMINA GRASAS

fat eraser
 éliminateur de graisse
 eliminatore di grasso
 remove-gorduras



SISTEMA PATENTADO QUE CAPTURA EL EXCESO DE GRASA DE LAS COMIDAS DE FORMA EFICAZ
 patented system that effectively soaks up the excess fat from food
 système breveté qui capture efficacement l'excès de graisse des aliments
 sistema brevettato che raccoglie l'eccesso di grasso nei piatti in maniera efficace
 sistema patentado que captura o exceso de gordura das comidas de forma eficaz



INCLUYE ELIMINADOR MINI
 includes smaller fat eliminator
 inclut un mini éliminateur
 include l'eliminatore mini
 inclui removedor mini



ref.	cms.		Bar Code
776600	9	1/6	8411922087864

SEPARADOR DE GRASAS CON FILTRO/JARRA MEDIDORA

grease/oil separator-measuring jug
 pichet de mesure séparateur de graisse
 garrafa misuratrice separa grassi
 jarra medidora separa gordura



PLASTIC



ref.	lts.		Bar Code
795900	1,00	6/6/24	8411922093704

LUPA PARA FRIGORÍFICO

magnifying glass for refrigerator
 loupe pour réfrigérateur
 lupe für den kühlschrank
 lupa para frigorífico



ibili design

luz
light

imán
magnet



PLASTIC

GLASS

Ayuda a leer: Instrucciones, recetas, ingredientes, fechas de caducidad ...

It helps you reading: instructions for use, recipes, ingredients, date of expiry...

ref.	cms.	∅		Bar Code
708800	18,5	8	6/36	8411922441406



NO INCLUIDAS
NOT INCLUDED

PANERA CON TAPA-TABLA DE CORTE

bread bin with lid-cutting board
boîte à pain avec couvercle-planche à découper
brotkasten mit schneidebrett im deckel
recipiente para o pão com tampa-tábua para cortar



PP+
BAMBOO

BPA

tapa-tabla de corte
cutting board - lid

ref.	Cms	H		Bar Code
754410	34x18	13	1/6	8411922448498

PANERA BAGUETTE

baguette basket
boîte à pain (baguette)
baguette-kasten
caixa para guardar o pão



tapa-tabla de corte
cutting board - lid

PP+
BAMBOO



ref.	Cms	H		Bar Code
754420	39,5x15	10	6	8411922453614

PANERA INOX

bread box
boîte à pain
caixa para pão



INOX /
S. STEEL

M

L



ref.	cms	H		Bar Code
765400	30x28	17	1/4	8411922440270
765410	44x28	17	1/4	8411922440287

M
L

BOLSA PARA PAN

bread bag
sac à pain
brotbeutel
saco para pão

POLYESTER



lilil design

BOLSA PARA BAGUETTE

baguette bag
sac à baguette
baguettebeutel
saco para baguetes

POLYESTER



lilil design

Mantienen el
pan fresco más
tiempo
Keep bread
fresh for longer

ref.	Cms	H		Bar Code
764838	27,50	38	6/48	8411922446135

ref.	Cms	H		Bar Code
764870	19	70	6/48	8411922446142

CESTA PARA PAN, FRUTA Y VERDURA

Basket for bread, fruit and vegetables

Panier pour le pain, les fruits et les légumes

Korb für Brot, Obst und Gemüse

Cesta para pão, frutas e verduras

ALGODON/
COTTON

METALLIC



RECTANGULAR



Rejilla metálica
metallic wire

ref.	Cms	H		Bar Code
705920	20x16	10	6/24	8411922456356
705925	20x18	12	6/24	8411922456363

REDONDA / ROUND



ref.	Cms	H		Bar Code
706020	20	15	6/24	8411922456370
706025	25	18	6/24	8411922456387

TAPA DE CRISTAL CON BASE DE MADERA

Glass cover with wooden base

Couvercle en verre avec fond en bois

Holzuntersatz mit glasdeckel

Tampa de vidro com base de madeira

Elegante y totalmente transparente
Elegant and completely transparent

BAMBOO

GLASS

M

ref.	∅		Bar Code
715518	18	1	8411922455274



L

ref.	∅		Bar Code
715520	20	1	8411922455281



XL

ref.	∅		Bar Code
715526	26	1	8411922455298



XXL

ref.	∅		Bar Code
715530	30	1	8411922458442



JARRA RECTA DE AGUA

water pitcher
pot à eau
jarra de água



INOX /
S. STEEL

ref.	Lts.		Bar Code
721820	2	4/12	8411922079999

LECHERA

Milk churn
Bidon à lait
Bidone di latte
Leiteira



ALUMINIUM

ref.	Ø	Lts.	H		Bar Code
151215	11,5	1,5	21,5	6	8411922459081
151220	12	2	20,5	6	8411922459098

BANDEJA DE CAMBIOS

bill holder
porte addition à pince
bandeja com pinça para notas



INOX /
S. STEEL

ref.	cms.		Bar Code
721917	17x10,50	6/72	8411922080018

RABANERA

appetizer dish
ravier
pratinho



INOX /
S. STEEL

ref.	cms.		Bar Code
722013	13x6	6/288	8411922080025

ESCURRIDERA CON BASE PRISMA

colander prisma
passoire prisma
küchensieb prisma
escoador prisma



INOX /
S. STEEL

ref.	cms.		Bar Code
714620	20 13	6/24	8411922452969
714624	24	4/16	8411922204179

COLADOR PRISMA

strainer
passoire
passador



INOX /
S. STEEL

ref.	cms.		Bar Code
714720	20	4/16	8411922204186

ESCURRIDERA CON BASE CLÁSICA

colander with stand
passoire sur pied
escoador de ervas com base



INOX /
S. STEEL

ref.	cms.		Bar Code
711114	14	6/72	8411922204407
711124	24	6/24	8411922622225

COLADOR

strainer
passoire
passador



INOX /
S. STEEL

ref.	cms.		Bar Code
711020	20	6/48	8411922622218

ESCURRIDOR PARA OLLAS

casserole strainer
passoire pour faitout
escoador de tachos



ref.	cms.		Bar Code
728100	26	6/36	8411922084948

BOL ALTO SATÍN

tall satin bowl
récipient haut satin
hohe schale satin
tigela alta satin

INOX /
S. STEEL

ref.	cms.	H.	Lts.		Bar Code
730514	14	7,5	0,7	6/48	8411922452518
730518	18	10	1,4	6/24	8411922448207
730520	20	11	2,3	6/24	8411922452525
730522	22	12	2,8	6/24	8411922448214
730526	26	14	4,7	6/24	8411922448221
730530	30	16	7,9	6/12	8411922448238



BOL INOX

bowl
saladier
tigela

INOX /
S. STEEL



ref.	Cms.	lts.		Bar Code
717008	8	0,16	6/24	841192244983
717012	12	0,50	6/24	8411922076950
717014	14	0,60	6/24	8411922076967
717016	16	0,90	6/24	8411922076974
717018	18	1,30	6/24	8411922076981
717020	20	2,00	6/24	8411922076998
717022	22	2,60	6/24	8411922077032
717025	25	4,00	6/6	8411922077131
717030	30	6,00	6/24	8411922077230

BOL

bowl
bol
tigela

INOX /
S. STEEL



ref.	cms.	lts.		Bar Code
710112	12	0,35	6/120	8411922423396
710116	16	0,70	6/120	8411922622072
710119	19	1,00	6/120	8411922622089
710124	24	2,50	6/60	8411922622096
710129	29	4,50	6/60	8411922622102



BANDEJA OVAL I-CHEF

oval platter
plat ovale
tablett oval
bandeja oval

INOX /
S. STEEL
18%



0,5 mm



ref.	cms.		Bar Code
700825	25x17	6/24	8411922453072
700830	30x20	6/24	8411922453089
700835	35x25	6/24	8411922453096
700840	40x28	6/24	8411922453102

BANDEJA OVAL

oval platter
plat ovale
bandeja oval

INOX /
S. STEEL



ref.	cms.		Bar Code
710030	30	6/48	8411922622010
710035	35	6/48	8411922622027
710040	40	6/48	8411922622034

BAJOPLATO

charger plate
dessous assiete
prato marcador

INOX /
S. STEEL



ref.	cms.		Bar Code
715932	32	12/48	8411922070149

JARRA DE AGUA CON RETÉN

water pitcher
pot à eau
jarro de agua

INOX /
S. STEEL



ref.	lts.		Bar Code
711620	2,00	1/24	8411922622287

SALSERA

gravy boat
saucière
molheira

INOX /
S. STEEL
18/10



ref.	lts.		Bar Code
765500	0,23	6/72	8411922208764

EXPRIMIDOR INOX

fruit squeezer
presse-fruits
espremedor

INOX /
S. STEEL
18/10



ref.	cms.	lts.		Bar Code
765700	10	0,40	1/24	8411922208733

Kitchen Aids

PELAMANZANAS

apple peeler
 eplucher de pommes
 descascarador de maçãs



PELA, CORTA Y DESCORAZONA AL MISMO TIEMPO

peels, cuts and cores at the same time
 pèle coupe et elimine le trogon simultanément
 descasca, corta e retira o caroço ao mesmo tempo



ref.	cms.		Bar Code
725300	33	1/12	8411922082210

CORTADOR DE MANZANAS LUXE

apple slicer
 sectionneur à pommes
 cortador para maçãs



ref.		Bar Code
782912	6/24	8411922083200

DESCORAZONADOR

Apple corer
 Vide-pommer
 Entkerner
 Descaroador



INOX /
S. STEEL

ref.	Cms	Ø		Bar Code
682600	19,5	2,8	6/72	8411922455960

DESGRANADOR PARA GRANADAS

pomegranate deseeder
 égreuse à grenades
 sgranatore per melograno
 utensilio para retirar sementes de romã

PLASTIC



ref.	cms.		Bar Code
797000	18	6/6	8411922094114

VACIADOR DE MELÓN DOBLE

double melon baller
 double évidoir melon
 svuota melone doppio
 esvaciador de melão duplo

INOX /
S. STEEL



ref.	Ø		Bar Code
741600	2,5/3	6/144	8411922435382

CORTAPIÑAS "M"

pineapple slicer "M"
 épiluche-ananas "M"
 descaroçador de ananas "M"

PELA Y CORTA LA PIÑA EN RODAJAS PERFECTAS EN UNOS SEGUNDOS.

peel and cut pineapple into perfect slices in seconds.

épluche et coupe l'ananas et permet d'obtenir des rondelles parfaites en quelques secondes.

descasca e corta o ananás em rodela perfeitas em poucos segundos.



INOX /
S. STEEL



PLASTIC

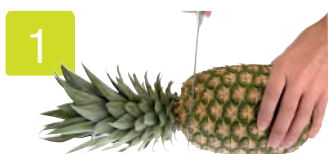

ref.	cms.	Ø	📦	Bar Code
784100	25	8,5	1/6	8411922084535 Inox

ref.	cms.	Ø	📦	Bar Code
784000	25	8,5	1/6	8411922084528 Plastic

CORTAPIÑAS "L"

pineapple slicer "L"
 épiluche-ananas "L"
 attrezzo taglia-ananas "L"
 descaroçador de ananás "L"



INOX /
S. STEEL

ref.	cms.	Ø	📦	Bar Code
784150	25	9,7	1/6/36	8411922434026

LAMINADOR DE AGUACATE

avocado slicer
 tranche-avocats
 avocado-schneider
 laminador de abacate



INOX /
S. STEEL

PLASTIC



ref.	cms.	📦	Bar Code
751610	24,5	6/96	8411922445053

DESCORAZONADOR DE PIMIENTOS (2 en 1)

pepper corer
 évideur à poivrons
 svuota peperoni
 utensilio para limpiar pimiento



ibili design

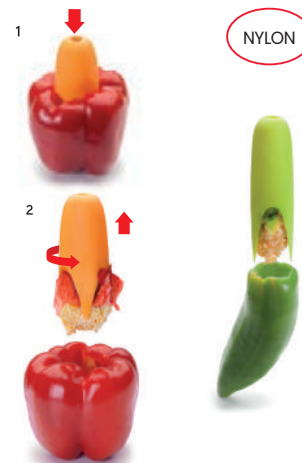

-2 tamaños de descorazonador para diferentes tipos de pimiento
 -2 sizes of corer for different type of peppers

ref.	Ø	H	📦	Bar Code
745500	3-4	11	6/72	8411922436655

CORTADOR DE SANDÍA

watermelon corer & server
 coupeur-serveur à pastèque
 taglia e servi anguria
 cortador de melancia



copyright



INOX / S. STEEL

"THE ORIGINAL"

-Cortar y servir con un solo utensilio
 -Cut & serve in one tool

ref.	cms.	H	📦	Bar Code
746100	21,5	7	6/72	8411922436822

CORTADOR DE SANDÍA

watermelon corer&server
 pastèque coupeur-serveur
 taglia e servi anguria
 cortador de melancia



copyright



ABS

"THE ORIGINAL"

-Cortar y servir con un solo utensilio
 -Cut & serve in one tool

ref.	Cms	📦	Bar Code
749800	22	6/72	8411922438956

DESHUESADOR DE MANGO

mango pitter
 dénoyauteur à mangue
 snocciolatore per mango
 descaroçador de manga



INOX / S. STEEL

PLASTIC

DESHUESADOR DE CEREZAS

cherry stoner
 dénoyauteur à cerises
 descaroçador cereza



PLASTIC



ref.	cms.	Ø	📦	Bar Code
744200	18,5	9	6/48	8411922436280

ref.	📦	Bar Code
774100	1/6	8411922079463

CORTADOR DE MELON Y PIÑA

melon-pineapple slicer
sectionneur à melon-ananas
cortador para melões-ananás

PLASTIC

INOX /
S. STEEL



ref.	cms.		Bar Code
777300	22	6/12	8411922080216

PELADOR DE NARANJA

Orange peeler
Éplucheur d'oranges
Orangenschäler
Descascador de laranjas

INOX /
S. STEEL



ref.	Cms		Bar Code
731300	10	12/96	8411922086102

LAMINADOR DE TRUFA / CHOCOLATE

truffle chocolate shaver
coupe truffles-chocolat
tagliatartufo e cioccolato
laminador de trufas-chocolate

INOX /
S. STEEL

adjustable blade / hoja ajustable



ref.	cms.		Bar Code
730100	18x9	6/72	8411922439779

SET CUCHILLOS PARA QUESO

cheese knife set
set de couteaux à fromage
set de coltelli de formaggio
conjunto de facas para queijo

INOX /
S. STEEL

MADERA
WOOD



ref.	Ø		Bar Code
782750	21	1/6/12	8411922440508

CORTADOR PARA QUESO EN BARRA 2 ESPESORES

Two thickness bar cheese slicer
Coupe-fromage en barre 2 épaisseurs
Käseschneider mit 2 schnittstärken
Cortador de queijo em barra 2 espessuras



2 espesores
2 thicknesses

INOX /
S. STEEL

PLASTIC

ref.	Cms		Bar Code
685700	23	6/144	8411922458855

BANDEJA DE MANTEQUILLA CON TAPA

butter dish with cover
beurrer avec couvercle
manteigueira com tampa



ref.	cms.		Bar Code
722900	19x12	1/6	8411922080575

LIRA CORTAQUESO BLANDO

cheese slicer
lyre à fromage
affetta formaggio
cortador de queijo



METALLIC

-Adjustable a diferentes grosores
-Adjustable to different thickness

ref.	cms.		Bar Code
744900	9,5	6/72	8411922436501

LIBRADOR

scoop
pell de cusino
schaufel
colhere de servir

MADERA
DE HAYA

BEECH
WOOD



ref.	Cms		Bar Code
683210	10	6/72	8411922456950
683214	14	6/72	8411922456967
683217	17	6/36	8411922456974

LIBRADOR

Ice shovel
Pelle à farine
Paletta per ghiaccio
Corredor

INOX /
S. STEEL



ref.	Cms		Bar Code
749924	24	6/72	8411922439045
749928	28	6/72	8411922439052

SET 3 LIBRADORES

scoop 3 set
set de 3 pelles de cuisine
schaufelsatz 3 stück
conjunto 3 colheres
de servir

PLASTIC

BPA

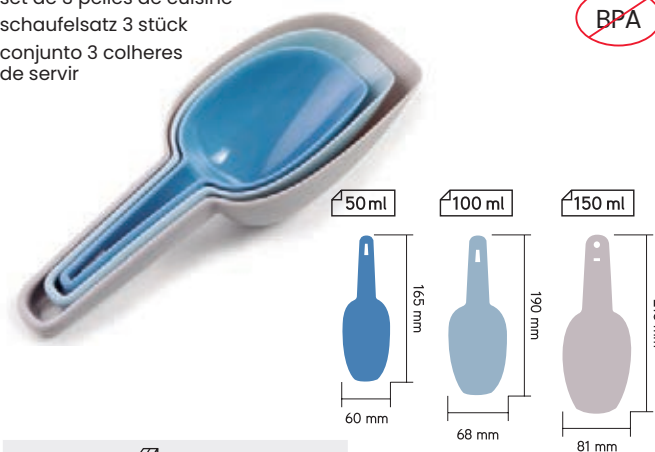

ref.		Bar Code
723300	1/12/36	8411922449815

CORTADOR DE FOIE

foie-gras cutter
coupe-foie-gras
cortador de foie-gras

INOX /
S. STEEL



ref.	cms.	📦	Bar Code
719600	21x13	1/6	8411922079791

LIRA PARA QUESO

cheese cutter
coupe fromage
cortador de queijo

INOX /
S. STEEL



ref.	cms.	📦	Bar Code
724912	12	6/36	8411922082142
724917	17	6/36	8411922082159
725012	12	10	8411922082166 hilo repuesto/spare wire/fil/fio
725017	17	10	8411922082173 hilo repuesto/spare wire/fil/fio

RECOGEMIGAS BISTROT

crumbs cleaner
ramasse-miettes
apanha-migalhas

INOX /
S. STEEL



ref.	cms.	📦	Bar Code
722400	21,5	1/6	8411922080148

PALA RECOGEVERDURAS BISTROT

choper/scrapper
ramasse légumes/herbes
pá recolhadora de verduras

INOX /
S. STEEL



ref.	cms.	📦	Bar Code
722224	24x15	1/6	8411922080087

TAPA MULTIUSO PROFESIONAL I-CHEF

professional multipurpose cover i-chef
couverture multiusages professionnel i-chef
coperchio multiusos professionale i-chef
tampa multiuso profesional i-chef

asa inox
s/steel handle

INOX /
S. STEEL



ref.	Cms	📦	Bar Code
714319	14-16-18	6/108	8411922440010
714323	18-20-22	6/108	8411922440027
714327	22-24-26	6/108	8411922440034
714331	26-28-30	6/108	8411922440041
714337	30-32-34-36	6/108	8411922439687
714343	36-38-40-42	6/108	8411922439694

TAPA VOLTEATORTILLAS

"easy over" lid, spanish omelette turner
 couvercle retourne-omelette aux pommes de terre
 tampa volta-tortilha de batatas

INOX /
S. STEEL



ref.	cms.	📦	Bar Code
715826	26	6/72	8411922068412
715830	30	6/36	8411922068429

TAPA MULTIUSO (con agujeros)

multipurpose cover
 couvercle multiusages
 tampa multiuso

INOX /
S. STEEL



ref.	cms.	📦	cms.	Bar Code
714219	19	6/108	14-16-18	8411922203943
714223	23	6/72	18-20-22	8411922203950
714227	27	6/72	22-24-26	8411922203967
714231	31	6/36	26-28-30	8411922203974
714237	37	6/36	30-32-34-36	8411922203981
714243	43	6/24	36-38-40-42	8411922203998

TAPA INOX (sin agujeros)

s/s cover
 couvercle inox
 tampa inox

INOX /
S. STEEL



ref.	cms.	📦	cms.	Bar Code
715719	19	6/108	14-16-18	8411922161700
715723	23	6/72	18-20-22	8411922161717
715727	27	6/72	22-24-26	8411922161724
715731	31	6/72	26-28-30	8411922161731
715737	37	6/36	30-32-34-36	8411922161748

TAPA ANTISALPICADURAS

splatter screen
 couvercle anti-projection
 tampa rede anti-salpicos

INOX /
S. STEEL



ref.	cms.	📦	Bar Code
704329	29	6/60	8411922079629

TAPA ANTISALPICADURAS

Splatter screen
 couvercle anti-projection
 Spritzschutz
 tampa rede anti-salpicos

INOX /
S. STEEL

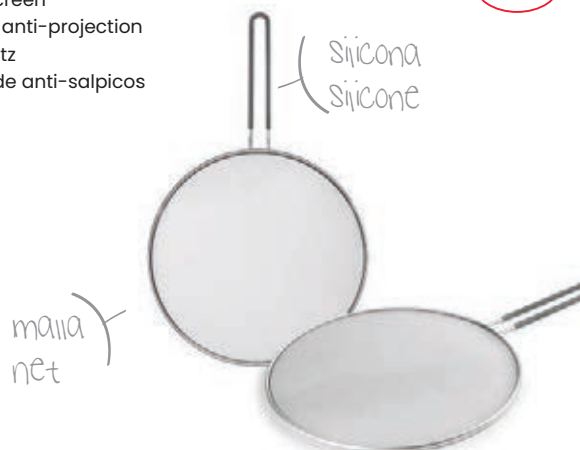

ref.	cms.	📦	Bar Code
703625	25	6	8411922458237
703630	30	6	8411922458244

POMO PARA TAPA DE CRISTAL

knos for glass cover
 poignée pour couvercle en verre
 griff aus edelstahl für glasdeckel
 pega para tampa de vidro

INOX /
S. STEEL

NEW



ref.	📦	Bar Code
971600	6/72	8411922459609

TAPA DE CRISTAL C/ POMO PLEGABLE

glass cover with foldable knob

couvercle en verre avec poignée pliante

coperchio in vetro impugnatura pieghevole

tampa de vidro com promo dobrável



ref.	cms.	📦	Bar Code
970914	14	6/24	8411922440096
970916	16	6/24	8411922440102
970918	18	6/24	8411922440119
970920	20	6/12	8411922440126
970922	22	6/12	8411922440133
970924	24	6/12	8411922440140
970926	26	6/12	8411922440157
970928	28	6/12	8411922440164
970930	30	6/12	8411922440171
970932	32	6/6	8411922440188
970936	36	6/6	8411922440201

TAPA DE CRISTAL

glass cover

couvercle en verre

tampa de vidro



ref.	cms.	📦	Bar Code
970712	12	6/24	8411922457247
970714	14	6/6	8411922439991
970716	16	6/6	8411922161762
970718	18	6/6	8411922161779
970720	20	6/6	8411922161786
970722	22	6/6	8411922161793
970724	24	6/6	8411922161809
970726	26	6/6	8411922161816
970728	28	6/6	8411922161823
970730	30	6/6	8411922161830
970732	32	6/6	8411922161847
970736	36	6/6	8411922433265

TAPA PARA PLANCHA GRILL

contact grill cover

couvercle pour plancha/grill

deckel für grillplatte

tampa para placa de grelhar

perfecta para fundir queso
perfect for melting cheese

INOX /
S. STEEL



ref.	Ø	H.	📦	Bar Code
713914	14	6	6/48	8411922459449
713900	23,2	7,5	6	8411922450019

NEW

TAPA DE CRISTAL CON BORDE SILICONA

glass cover. silicone edge

couverde en verre. bord silicone

coperchio in vetro. bordo in silicone

tampa de vidro. junta silicone

max. 240°C



ref.	cms.	📦	Bar Code
970805	16+18+20	6/12	8411922448535
970800	18+20+22	6/6	8411922433340
970810	24+26+28	6/6	8411922433357
970815	28-30-32	6/6	8411922451542

TAPA DE CRISTAL POMO INOX

Glass cover s/steel knob

Couvercle en verre

Glasdeckel

Tampa de vidro



ref.	Ø	📦	Bar Code
971612	12	6/24	8411922457254
971614	14	6/24	8411922455380
971616	16	6/24	8411922455397
971618	18	6/24	8411922455403
971620	20	6/12	8411922455410
971622	22	6/12	8411922455427
971624	24	6/12	8411922455434
971626	26	6/12	8411922455441
971628	28	6/12	8411922455458
971630	30	6/12	8411922455465
971632	32	6/6	8411922455472

Organización



PORTAUTENSILIOS "PREMIER"
kitchen tools holder "premier"
porte ustensiles de cuisine "premier"
porta utensilios de cozinha "premier"

INOX /
S. STEEL

ref.	cms.	📦	Bar Code
708706	6	6/144	8411922081473
708710	10	6/72	8411922081480
708700	12	6/48	8411922076257

PORTAUTENSILIOS
utensil holder
porte-ustensiles
portautensili
porta utensilios

PORCELANA



ref.	Ø	H	📦	Bar Code
748601	12	14	6/12	8411922438291
748602	12	14	6/12	8411922438307

black / negro
red / rojo

PORTAUTENSILIOS GIRATORIO
rotating utensil holder
porte-ustensiles rotatif
portautensilii rotante
porta utensilios giratório

INOX /
S. STEEL
18%

PLASTIC

Copyright



ref.	cms.	📦	Bar Code
797200	14x18	4/4	8411922433012

PORTAUTENSILIOS RECTANGULAR
rectangular utensil holder
porta-ustensiles rectangulaire
portautensilii rettangolare
porta utensilios retangular

INOX /
S. STEEL
18%

PLASTIC

Copyright



ref.	cms.	📦	Bar Code
797250	22x18	4/4	8411922433029

ESCURRECUBIERTOS
cutlery drainer
égouttoir à couverts
escorredor de talheres

INOX /
S. STEEL



ref.	cms.	📦	Bar Code
714000	8x13	6/72	8411922203929

PORTAUTENSILIOS DE COCINA
kitchen tools holder
porte ustensiles de cuisine
porta utensilios de cozinha

INOX /
S. STEEL



ref.	cms.	📦	Bar Code
714100	10x18	6/48	8411922203936

PORTAUTENSILIOS AMERICANO
american utensil organiser
porte-ustensiles américain
amerikanischer küchenutensilienhalter
porta-utensílios americano

INOX /
S. STEEL



ref.	cms.	H.	Lts.	📦	Bar Code
700512	12x16	16	1,8	6/24	8411922447057

PORTAUTENSILIOS CON JABONERA

Kitchen soap dispenser caddy

Porte-utensiles avec distributeur de liquide vaisselle

Spülbeckenorganiser mit Spülmittelspender

Porta-utensilios com dispensador de detergente

INOX /
S. STEEL

PLASTIC



ref.	cms.	H	📦	Bar Code
797220	18x12,5	8,5	1/6	8411922457889

PORTACUBIERTOS

Cutlery bucket

Pot range-couverts

Besteckbehälter

Recipiente para talheres

INOX /
S. STEEL

PLASTIC



ref.	cms.	H	📦	Bar Code
797210	18x18,5	13	1/6	8411922457872

ORGANIZADOR DE CAJONES

drawer organizer

organisateur de tiroir

schubladenregal

organizador de gavetas

materiai antideslizante
non-slip material

PLASTIC

SILICONE

~~BPA~~

ANTIDESLIZANTE
NON-SLIP

4 puntos de apoyo
4 non-slip feet

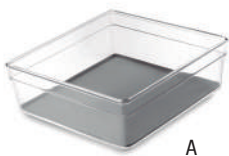

A



B

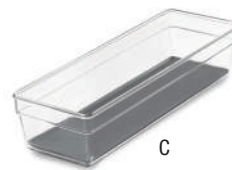

C



D

ref.	cms.	H	📦	Bar Code
690115	15,5x15,5	5,5	6/24	8411922445183
690108	8x8	5,5	6,24	8411922441152
690124	8x24,5	5,5	6,24	8411922445169
690132	8x32,5	5,5	6/24	8411922445176
690122	15,5x22,8	5,5	6/12	8411922445190
690138	15,5x38,3	5,5	6/12	8411922445104

A

B

C

D

E

F

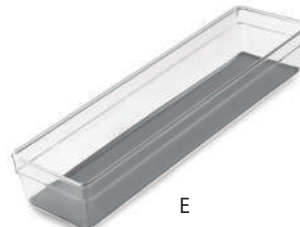

E

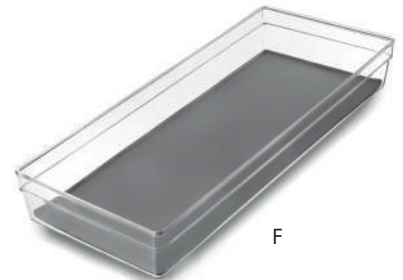

F

CUBTERO

cutlery tray

plateau pour couverts

einlage

organizador de talheres



ref.	cms.	H	📦	Bar Code
690233	27x33,5	5,5	6/12	8411922446111

HUEVERA 14 UNIDADES

egg holder 14 units
boîte à oeufs 14 unités
eierhalter für 14 eire.
caixa para ovos 14 unidades



ref.	cms.	H	📦	Bar Code
690014	11,5x37	8	6	8411922445145

HUEVERA 18 UNIDADES

egg holder 18 units
boîte à oeufs 18 unités
eierhalter für 18 eire.
caixa para ovos 18 unidades

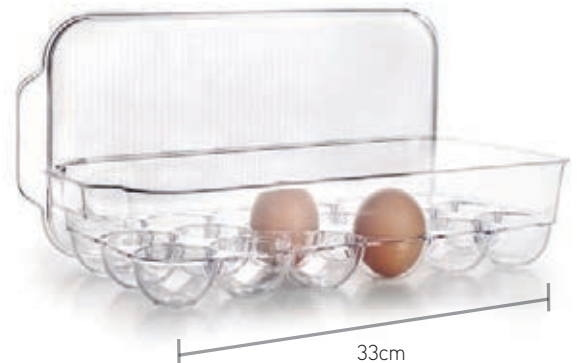

ref.	cms.	H	📦	Bar Code
690018	33x17	8	6	8411922457223

CESTA PARA HUEVOS

Egg basket
Panier à œufs
Eierkorb
Cesto para ovos



ref.	cms.	H	📦	Bar Code
684700	19,5	13	6	8411922457971

COLADOR MALLA media bola

strainer
passoire
coador de rede meia/bola



ref.	cms.	📦	Bar Code
703807	7,5	6/72	8411922069679
703810	10,0	6/72	8411922069686
703812	12,5	6/72	8411922069693
703815	15,0	6/72	8411922069709
703818	18,0	6/72	8411922069716
703820	20,0	6/72	8411922069723

COLADOR MALLA media bola

strainer
passoire
coador de rede meia/bola



ref.	cms.	📦	Bar Code
704007	7	6/72	8411922069778
704008	8	6/72	8411922069785
704009	9	6/72	8411922069792
704010	10	6/72	8411922069808
704012	12	6/72	8411922069815
704014	14	6/72	8411922069822
704016	16	6/72	8411922069839
704018	18	6/72	8411922069846
704020	20	6/72	8411922069853

COLADOR ECO

strainer eco
passoire eco
sieb eco
passador eco



ref.	cms.	📦	Bar Code
703007	7	6/96	8411922451825
703008	8	6/96	8411922451832
703010	10	6/96	8411922451849
703012	12	6/96	8411922451856
703014	14	6/48	8411922451863
703015	15	6/48	8411922451870
703016	16	6/48	8411922451887
703018	18	6/48	8411922451894
703020	20	6/48	8411922451900
703022	22	6/48	8411922451917
703025	25	6/48	8411922451924

COLADOR MALLA cónico

conical strainer
passoire conique
coador de rede cónico

INOX /
S. STEEL
18/10

MALLA
DOBLE



ref.	cms.		Bar Code
703907	7,5	6/72	8411922069730
703910	10,0	6/72	8411922069747
703915	15,0	6/72	8411922069761

COLADOR MALLA PLÁSTICA

mini plastic mesh colander
passoire maille plastique mini
colino in maglie di plastica mini
coador de rede plástica mini

SPECIAL
KÉFIR

PLASTIC



INOX /
S. STEEL
18/10



ref.	cms.		Bar Code
734300	8	6/24	8411922087925
734310	10	6/24	8411922090468
734314	14	6/24	8411922090475

TAPALIMENTOS MALLA

food cover
cloche alimentaire
rede "tapa-pratos"



ref.	cms.		Bar Code
704129	29	6/72	8411922069877

COLADOR CHINO

chinese strainer
passoire "chinois"
coador chinês

INOX /
S. STEEL



ref.	Cms.		Bar Code
716816	16	6/36	8411922073539
716818	18	6/36	8411922077704
716820	20	6/12	8411922077711

MANO PARA CHINO

china cap pestle
poussoir pour chinois
pestello per colino chinese
coador chinês de mão

MAPLE
WOOD

MADERA
DE ARCE



ref.	cms.		Bar Code
729400	26x4	6/96	84119222439908

HARINERO

flour bin mesh
tamis à farine à glissière
peneira para farinha

INOX /
S. STEEL

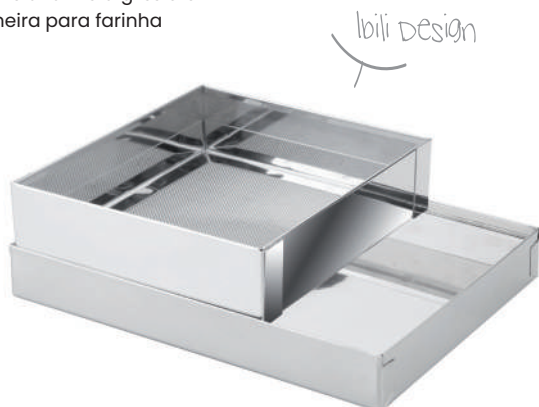

ref.	cms.	H.		Bar Code
718300	25	20	1/4	8411922078725

HARINERO CON TAPA CONFORT

flour bin mesh
tamis à farine à glissière
mehlstreuer
peneira para farinha

PLASTIC



ref.	cms.	H.		Bar Code
755600	27,5x22	5,5	1/6/12	8411922447118

PASAPURÉS LUXE 3 DISCOS 20 cm

food mill 3 sieves luxe 20 cm
 presse puree 3 disques luxe 20 cm
 pasaverdure 3 dischi luxe 20 cm
 passe vite com 3 discos 20 cm

INOX /
S. STEEL
18/10

NYLON

3 discos
discs
disques
dischi
discos



ref.	Cms.	H.		Bar Code
742420	20	8,5	1/6	8411922435429

PASAPURÉS LUXE 3 DISCOS 24 cm

food mill 3 sieves luxe 24 cm
 presse puree 3 disques luxe 24 cm
 pasaverdure 3 dischi luxe 24 cm
 passe vite com 3 discos 24 cm

INOX /
S. STEEL
18/10

NYLON

3 discos
discs
disques
dischi
discos



ref.	Cms.	H.		Bar Code
742424	24	10	1/4	8411922435436

PASAPURES CON 3 DISCOS CLÁSICA

food mill with 3 sieves
 presse puree avec 3 disques
 passe vite com 3 discos

INOX /
S. STEEL
18/10



ref.	cms.		Bar Code
765320	20	6/6	8411922206395
765324	24	6/6	8411922206401

PASAPURES PLASTICO 1 DISCO

1 sieve
 1 disque
 1 disco

PLASTIC



ref.	Cms.		Bar Code
709320	20	6	8411922076936

PASADOR DE FRUTAS

sieve with crank
 passoir à coulis
 coador de frutas

INOX /
S. STEEL



ref.	cms.		Bar Code
727220	20	6/12	8411922083798

TERMÓMETRO PARA HORNO

oven thermometer
thermomètre pour cuisson au four
termometro da forno
termômetro para forno

max. 250°C  



ref.	cms.		Bar Code
743400	7x6	6/72	8411922435931

TERMÓMETRO ALIMENTOS CON SONDA

food thermometer with probe
thermomètre à sonde pour aliments
termometro alimenti con sonda
termômetro para alimentos com sonda

max. 250°C  



ref.	cms.		Bar Code
743401	14	6/72	8411922435948

TERMÓMETRO PARA CARNE CON SONDA

meat thermometer with probe
thermomètre à sonde pour viandes
termometro per carne con sonda
termômetro para carnes com sonda

max. 150°C  



FOR OIL

ref.	cms.	∅		Bar Code
743402	16	5	6/72	8411922435955

TERMÓMETRO ALIMENTOS/HORNO CON SONDA

food/oven thermometer with probe
thermomètre à sonde pour aliments/four
termometro alimenti + forno con sonda
termômetro para alimentos + forno com sonda

max. 250°C  



FOR OIL

ref.	cms.	∅		Bar Code
743403	13	7	6/72	8411922435962

TERMÓMETRO DIGITAL CON SONDA

digital thermometer with probe
thermomètre numérique à sonde
termometro digitale con sonda
termômetro digital com sonda

max. 300°C  min. -50°C

FOR OIL

**BATTERY 1,5V 2XLR44
NOT INCLUDED**



ref.	cms.		Bar Code
743404	22	6/72	8411922435979

SET 3 TERMÓMETROS HORNO CON SONDA (PATATA, CARNE, AVES)

set 3 oven thermometers (potato, meat, poultry)
set 3 thermomètres pour four (pommes de terre, volaille, autres viandes)
set 3 termometri da forno (patate, carne, pollame)
set 3 termômetros para forno (batata, carne, aves)

max. 250°C 



ref.	cms.	∅		Bar Code
743406	7	2,5	6/72	8411922436730

TERMÓMETRO DIGITAL MAGNÉTICO CON SONDA

digital/magnetic thermometer with probe
thermomètre numérique/magnétique à sonde
termometro digitale/magnetico con sonda
termômetro digital/magnético com sonda

**BATTERY 1 PC AAA
NOT INCLUDED**



max. 300°C min. -50°C
INOX / S. STEEL PLASTIC

115 cm

FOR OIL

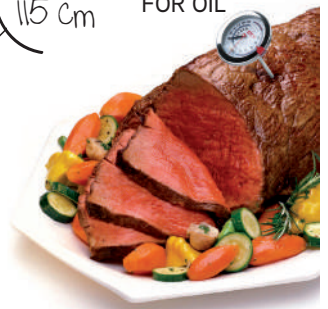

ref.	cms.	📦	Bar Code
743405	6x7	6/72	8411922435986

TERMÓMETRO FRIGORÍFICO - CONGELADOR

fridge-freezer thermometer
thermomètre digital
pour réfrigérateur - congélateur
thermometer für kühlschrank-tiefkühler
termômetro para frigorífico-congelador

INOX / S. STEEL

max. 20°C min. -20°C



ref.	Cms.	📦	Bar Code
743409	7x7	6/72	8411922448818

TERMÓMETRO FRIGORÍFICO - CONGELADOR

fridge-freezer thermometer
thermomètre digital
pour réfrigérateur - congélateur
thermometer für kühlschrank-tiefkühler
termômetro para frigorífico-congelador

DIGITAL

max. 60°C min. -20°C



ref.	cms.	📦	Bar Code
743410	7x4,5	6/72	8411922448825

1X
CR2032
NO INCLUIDAS
NOT INCLUDED

DISPENSADOR FILM/ PAPEL 3 EN 1

3 in 1 s/steel multi roll
dispenser
distributeur film/papier 3 en 1
erogatore di alluminio/
pellicola 3 in 1
dispensador de filme/papel
3 em 1

INOX / S. STEEL PLASTIC



ref.	cms.	📦	Bar Code
739200	35x15x7	1/6	8411922433524

SOPORTE DISPENSADOR DE PAPEL

paper towel holder
support pour papier essuie-tout
küchenrollenhalter
suporte para papel de cozinha

INOX / S. STEEL PLASTIC

CON VENTOSA
WITH SUCTION BASE



ref.	cms.	📦	Bar Code
712200	33	6	8411922454529

ABREBOTES

can opener
ouvre-bocaux
abre-boiões

INOX / S. STEEL
18/10



ref.	cms.	📦	Bar Code
774700	16x10	6/72	8411922079562

ABRETARROS Y BOTELLAS MÚLTIPLE

jar and bottle opener
l'ouvre-bocaux et bouteilles
flaschen- und deckelöffner
abridor de frascos e garrafas

PLASTIC
RUBBER



ref.	cms.	📦	Bar Code
763300	22,5x8,5	6/24/96	8411922446128

ABREBOTES EASY OPEN

jar opener easy open
l'ouvre-bocaux easy open
apprivasetti easy open
abridor de frascos easy open



-Elimina el vacío
-Pops the vacuum

ref.	cms.		Bar Code
743300	14	10	8411922435924

ABRETARROS EASY OPEN

jar opener easy open
ouvre-bocaux easy open
apprivasetti easy open
abridor de frascos easy open

PLASTIC



ref.	Cms		Bar Code
750100	14	24	8411922439199

ALFOMBRILLA ESCURREPLATOS

Dish drainer mat.
Tapis égouttoir
Geschirr-Abtropfmatte
Tapete escorredor de pratos



SILICONE



ref.	cms.		Bar Code
685300	40x30	6/36	8411922458251

ESCURRIDOR DE PLATOS Y CUBIERTOS

dish and cutlery drainer
égouttoir à assiettes et couverts
scolapiatti e posate
escorredor de pratos e talheres

PLASTIC

ALUMINIUM



ref.	Cms		Bar Code
720700	41x20	1/4	8411922439298

ESCURRIDOR DE PLATOS Y CUBIERTOS

dish and cutlery drainer
égouttoir à assiettes et couverts
geschirrabtropfständer
escorredor de pratos e talheres

PLASTIC



ref.	cms.	H		Bar Code
721600	44x22	13	1/6	8411922441529

RECICLADOR DE ACEITE H-CLASS

kitchen oil recycler
recycleur d'huile
reciclatore per olio
reciclador de óleo



ref.	Cms.	H.	lts.	📦	Bar Code
743500	10	12,5	0,5	1/6/24	8411922439793
743510	10	12,5	0,5	1/6/24	8411922439809

(1) meat/carne
(2) fish/pescado

RECICLADOR DE ACEITE SQUARE

kitchen oil recycler square
recycleur d'huile square
reciclatore per olio square
reciclador de óleo square



ref.	Cms.	H.	lts.	📦	Bar Code
743550	10x10	12	0,600	1/6/24	8411922451405
743560	10x10	12	0,600	1/6/24	8411922451412

(1) meat/carne
(2) fish/pescado

RECUPERADOR DE ACEITE LUXE

Luxe cooking oil strainer pot
Récupérateur d'huile Luxe
Ölauffangbehälter Luxe
Recuperador de óleo de cozinhar Luxe

INOX/S. STEEL 18/10

con filtro
with filter



ref.	Cms.	H.	lts.	📦	Bar Code
714400	10	0,75	10	6/24	8411922079616
714401	10	0,75	10	6/24	8411922080063

(1) meat/carne
(2) fish/pescado

GRASERA PROMO

oil strainer
pot à huile
aproveitador de azeite



INOX /
S.STEEL

ref.	lts.	📦	Bar Code
700001	0,50	6/72	8411922161663
700002	0,50	6/48	8411922161670

carne / meat
pescado / fish

GRASERA CLASICA

oil strainer
pot à huile
aproveitador de azeite



INOX /
S.STEEL
18/10

ref.	lts.	📦	Bar Code
700201	0,50	6/72	8411922604016
700203	1,00	6/72	8411922604030
700202	0,50	6/72	8411922604023
700204	1,00	6/72	8411922604047

carne / meat
carne / meat
pescado / fish
pescado / fish

ACEITERA

oil can
huilier
almotolia



INOX /
S. STEEL
18/10

ref.	lts.		Bar Code
700105	0,50	6/120	8411922603507
700107	0,70	6/120	8411922603750
700112	1,20	6/72	8411922603125

ACEITERA " VIRGEN"

oil can
huilier
oilcainos 18/19
almotolia



INOX /
S. STEEL
18/10



ref.	H	Lts.		Bar Code
705205	15	0,500	1/24	8411922434149

ACEITERA "OLIVA" (caja individual)

oil can (gift box)
huilier (boîte indiv.)
almotolia (caixa indiv.)



INOX /
S. STEEL
18/10

ref.	lts.		Bar Code
705005	0,5	1/16	84119222072532

ACEITERA "ARBEQUINA" (caja individual)

oil can (gift box)
huilier (boîte indiv.)
almotolia (caixa indiv.)



INOX /
S. STEEL
18/10

ref.	lts.		Bar Code
705105	0,5	1/24	84119222072549

ACEITERA IBÉRICA

oil can
huilier
oliera
almotolia



INOX /
S. STEEL

ref.	Lts.		Bar Code
709703	0,300	1/24	8411922077520
709705	0,500	1/6	8411922077544
709710	1,000	1/24	8411922077537

ACEITERA ANTIGOTEO

anti-drip oil container
huilier anti-goutte
oliera antigoccia
almotolia anti-gotejo

No disponible en Portugal
Not available in Portugal

INOX /
S. STEEL

ref.	Lts.		Bar Code
731702	0,250	6/24	8411922086157
731705	0,500	6/24	8411922086164
731707	0,750	6/24	8411922086171
731710	1,000	6/72	8411922436532



ACEITERA CRISTAL PROBETA SPRAY

glass oil cruet spray
huilier en verre éprouvete spray
oliera conica in vetro spray
almotolia cristal proveta spray



BOROSILICATE

ref.	H	Lts.		Bar Code
797902	19	0,250	6/24	8411922433555

ACEITERA ANTIGOTEO OPTIMA

anti-drip oil container
huilier anti-goutte
oliera antigoccia
almotolia anti-gotejo

INOX /
S. STEEL

ref.	Lts.		Bar Code
745605	0,500	1/6/24	8411922436662
745610	1,00	1/6/24	8411922436679



ACEITERA CRISTAL PROBETA

glass oil cruet
huilier en verre éprouvete
oliera conica in vetro
almotolia cristal proveta

BOROSILICATE



ref.	Lts.	📦	Bar Code
755001	0,150	6/24	8411922086652
755002	0,250	6/48	8411922080919
755005	0,5	6/24	8411922080926
755010	1,00	6/12	8411922080933

ALCUZA OLI D'OLIVA

oil can
huilier
ölkanne
almotolia

BOROSILICATE



NEW

ref.	Lts.	📦	Bar Code
628002	0,250	6/48	8411922470390
628005	0,500	6/24	8411922470406
628007	0,700	6/18	8411922470413

ACEITERA BOMBADA

convex oil container
huilier bombé
bauchförmige ölkanne
azeiteiro arredondado



BOROSILICATE

ref.	Lts.	📦	Bar Code
751215	0,150	6/24	8411922441468
751230	0,300	6/24	8411922441475
751250	0,500	6/24	8411922071054

ACEITERA CILÍNDRICA

cylindrical oil container
huilier cylindrique
zylindrische ölkanne
azeiteiro cilíndrico



BOROSILICATE

ref.	Lts.	📦	Bar Code
751315	0,150	6/24	8411922441499
751325	0,250	6/12	8411922441505
751350	0,500	6/12	8411922441078

ACEITERA PROBETA CUADRADA

glass oil cruet square
huilier en verre carré
oliera in vetro
almotolia cristal quadrada



BOROSILICATE

ref.	Lts.	📦	Bar Code
795612	0,125	6/24	8411922093650
795625	0,250	6/24	8411922093667
795650	0,500	6/12	8411922093674

ACEITERA PROBETA PIRAMIDAL

oil cruet pyramidal
huilier pyramidal
oliera piramidale
almotolia piramidal



BOROSILICATE

ref.	Lts.	📦	Bar Code
746902	0,250	6/24	8411922437232
746905	0,500	6/24	8411922437249

ACEITERA PROBETA BALÓN

round-bottom flask oil cruet
huilier conique ballon
ölfflasche ballonglas
dispensador de azeite
tipo proveta balón



BOROSILICATE

ref.	Lts.	📦	Bar Code
752302	0,250	6/24	8411922448443
752305	0,500	6/12	8411922448450

ACEITERA PROBETA MATRAZ

conical flask oil cruet
huilier conique fiole
ölfflasche kolbenglas
dispensador de azeite
tipo proveta cônica



BOROSILICATE

ref.	Lts.	📦	Bar Code
753202	0,250	6/24	8411922448467
753205	0,500	6/12	8411922448474

ACEITERA DE BOCA ANCHA BAENA

wide mouth oil dispenser
huilier à bec large
ölkug with
weiter öffnung
spout
dispensador
de azeite
de boca larga

BOROSILICATE

TAPON DE SILICONA
SILICONE COVER



NEW

ref.	Ø	H	Lts.	☐	Bar Code
687110	10	21	1,00	6	8411922459593

DISPENSADOR DE ACEITE/ VINAGRE CON TAPA BASCULANTE

oil and vinegar dispenser with a flip lid
huilier/vinaigrier avec couvercle
basculant
essig-/öl-spender mit neigeöffnung
dispensador de azeite/vinagre com
tampa basculante

BOROSILICATE

con graduación
with graduation



ref.	Ø	H	Lts.	☐	Bar Code
684035	6,5	20	0,350	6/48	8411922457339
684050	6,5	25	0,500	6/48	8411922457346

PULVERIZADOR DE ACEITE-VINAGRE DOBLE

double vinegar-oil sprayer
double vaporisateur d'huile/vinaigre
distributore spray per olio e aceto
pulverizador de óleo-vinagre duplo

PLASTIC



ref.	Lts.	☐	Bar Code
790300	0,200	1/6	8411922090505

PULVERIZADOR DE ACEITE

oil spray
vaporisateur d'huile
ölspray
azeitera spray



BOROSILICATE

POR BOMBEO
BY PUMPING



ref.	Lts.	☐	Bar Code
701117	0,170	6/48	8411922448436

SET 2 ACEITERAS ECO

set 2 oil containers
set 2 huiliers
set 2 ölkanne
set 2 azeiteros

GLASS



ref.	Lts.	☐	Bar Code
713302	0,250	12/168	8411922453935

ACEITERA 2 USOS (SPRAY-VERTEDOR)

oil cruet 2 uses (spray+pourer)
huilier 2 functions (vaporisateur + verseur)
oliera doppio utilizzo (spruzza + versa)
galheteiro de 2 usos (pulverizar + verter)

PLASTIC



ref.	Lts.	H	☐	Bar Code
741100	0,200	17	6/48	8411922435153

SET VINAGRERAS 4 PIEZAS

salad set 4 pieces
vinaigrier 4 pièces
galheteiro 4 peças

INOX /
S. STEEL
18%

GLASS



ref.	lts.	📦	Bar Code
768500	0,175	1/6	8411922209297

SET VINAGRERAS 2 PIEZAS

salad set 2 pieces
vinaigrier 2 pièces
galheteiro 2 peças

INOX /
S. STEEL
18%

GLASS



ref.	lts.	📦	Bar Code
768600	0,175	1/6	8411922207895

VINAGRERAS

vinegar bottles
vinaigriers
galheteiros

INOX /
S. STEEL
18%

GLASS



ref.	lts.	📦	Bar Code
755200	0,175	6/48	8411922069563

RECAMBIO BOTELLA SALERO

salt shaker spare bottle
bouteille de rechange salière
troca de garrafa saleiro

INOX /
S. STEEL
18%

GLASS



ref.	lts.	📦	Bar Code
769911	0,0375	24	8411922072242

SALERO-PIMENTERO

salt & pepper set
poivriere-salière
saleiro-pimenteiro

INOX /
S. STEEL
18%

GLASS



ref.	lts.	📦	Bar Code
768700	0,0375	1/6	8411922209310

SET SALERO+PIMENTERO PEQUEÑOS

small salt & pepper set
lot poivriere et salière
jogo saleiro-pimenteiro

INOX /
S. STEEL
18%

GLASS



ref.	lts.	📦	Bar Code
768715	0,0375	1/24	8411922069662

SALERO GRANDE

large salt shaker
salière grand modele
saleiro grande

INOX /
S. STEEL
18%

GLASS



ref.	cms.	lts.	📦	Bar Code
755100	10x4	0,075	12/96	8411922069549

SALEROS/PIMENTEROS PEQUEÑOS

small salt /pepper shaker
petit poivriere/salière
saleiro/pimenteiro pequeno

INOX /
S. STEEL
18%

GLASS



ref.	📦	Bar Code
768710	12/96	8411922069655

DISPENSADOR DE MIEL

honey dispenser
doseur à miel
jarra de mel

ABS

GLASS



ref.	Its.	📦	Bar Code
755300	0,25	1/6	8411922069570

DISPENSADORES DE MIEL

honey dispenser
doseur à miel
jarra de mel

ABS

GLASS



ref.	Its.	📦	Bar Code
755305	0,25	6/48	8411922069587

DISPENSADOR DE QUESO

cheese shaker
saupoudreuse à fromage
queijeira

INOX /
S. STEEL
18%

GLASS



ref.	Its.	📦	Bar Code
755400	0,25	1/6	8411922069594

DISPENSADORES DE QUESO

cheese shakers
saupoudreuse à fromage
queijeira

INOX /
S. STEEL
18%

GLASS



ref.	Its.	📦	Bar Code
755405	0,25	6/48	8411922069600

DISPENSADOR DE AZUCAR

sugar dispenser
sucrier doseur
açucareiro

INOX /
S. STEEL
18%

GLASS



ref.	Its.	📦	Bar Code
755500	0,25	1/6	8411922069617

DISPENSADORES DE AZUCAR

sugar dispenser
sucrier doseur
açucareiros

INOX /
S. STEEL
18%

GLASS



ref.	Its.	📦	Bar Code
755505	0,25	6/48	8411922069624

AZUCARERO CON CUCHARILLA

sugar bowl with spoon
sucrier avec cuillère
açucareiro com colher

INOX /
S. STEEL
18%

GLASS



ref.	Its.	📦	Bar Code
768800	0,25	6/6	8411922209327

SALERO CÓNICO

conic salt shaker
salière conique
saliera conica
saleiro cónico

INOX /
S. STEEL
18%

GLASS



ref.	cms.	📦	Bar Code
743900	11	12/120	8411922436235

SET 3 CONTENEDORES C/TAPA PLÁSTICO

food containers, 3 pcs set with plastic lid
lot 3 boîtes, couvercle plastique
conjunto 3 lancheiras com tampa plástico

INOX /
S. STEEL



ref.	cms.	lts.	📦	Bar Code
712000	14	0,75	6/24	8411922423389
	16	1,20		
	18	1,50		

SALVAMANTEL EXTENSIBLE

foldable trivet
dessous de plat extensible
descanso de prato extensível



INOX /
S. STEEL



ref.	cms.	📦	Bar Code
724500	45x20	6/36	8411922082104

SERVILLETERO DE MESA

table napkin rack
porte-serviettes de table
porta-guardanapos de mesa



INOX /
S. STEEL

ref.	cms.	📦	Bar Code
724600	11,5 x 11	6/60	8411922082111

SERVILLETERO CON BOLA

napkin holder
porte-serviettes avec boule
porta-guardanapos com bola



INOX /
S. STEEL

ref.	cms.	📦	Bar Code
724700	17 x 17	1/6	8411922082128

BOTE RESIDUOS MESA

table bin
poubelle de table
caixa para resíduos de mesa



INOX /
S. STEEL
18%

ref.	cms.	H	📦	Bar Code
769200	11,7	16,5	1/24	8411922209471

REJILLA PARA FREGADERO

sink strainer
grille pour évier
filtro per lavello
grelha para a pia

PLASTIC



ref.	cms.	Ø	H	📦	Bar Code
748300	11	7	3	6/96	8411922437676

REJILLA FILTRO PARA FREGADERO

kitchen sink filter strainer
grille-filtre pour évier
abflusssieb
grelha-filtro
para a pia

INOX /
S. STEEL



ref.	Ø	📦	Bar Code
730907	7	6/120	8411922451375
730909	9	6/120	8411922451382
730911	11,5	6/120	8411922451399

FILTRO DE MALLA PARA FREGADERO

mesh sink strainer
filtre maillé pour évier
abflusssieb
Filtro de rede para a pia

INOX /
S. STEEL

NEW



ref.	Ø	📦	Bar Code
687507	7,5	6/120	8411922459821

SET 6 CUCHARILLAS PRESENTACIÓN

set of 6 presentation spoons

set 6 petites cuillères de présentation

set 6 cuchiani da presentazione

conjunto de 6 colheres para apresentação



ref.	cms.	H		Bar Code
731600	13	4,5	6/60	8411922086133

PLUMA PARA DECORAR PLATOS

spoon pen

cuillère plume

cucchichio piuma

colher caneta



ibili design



ref.	cms.		Bar Code
740900	17	6/120	8411922435108
740921	21	6/120	8411922441888

CUCHARA PARA ESFERIFICACIONES

balling spoon

cuillère pour sphérifications

löffel für kugelformen

colher para esferificações



ref.	cms.		Bar Code
711700	18	6/120	8411922441871

AGUJA DE BRIDAR

trussing needle

aiguille à brider

ago per imbrigliare

agulha de cozinha



ref.	cms.		Bar Code
796000	18	6/6/288	8411922093711

EXPRIMIDOR DE CÍTRICOS

citrus squeezer
presse-agrumes
spremiagrumi
espremedor de cítricos



MÁS CANTIDAD CON MENOS ESFUERZO
less effort, more juice
davantage de jus avec moins d'efforts
maggiore quantità di succo con meno sforzo
mais quantidade de sumo com menos esforço

ref.	cms.		Bar Code
788500	25x9	6/24	8411922089554

EXPRIMIDOR DE LIMONES LEMON

lemon squeezer
presse citron
spremitore per limone
espremedor limões



ALUMINIUM

ref.	∅		Bar Code
782310	6	6	8411922439977

EXPRIMIDOR DE LIMA GREEN

lime squeezer
presse Lime
spremitore per lime
espremedor limas



ALUMINIUM

ref.	∅		Bar Code
782410	5	6	8411922439984

CASCANUECES

nutcracker
casse-noix
quebra-noces



METALLIC

ref.	cms.		Bar Code
726300	18,5	6/6	8411922083606

PELADOR DE CASTAÑAS

chestnut peeler
coupe châtaignes
maronenschäler
descascador de castanhas



INOX / S. STEEL

PLASTIC

ref.	Cms		Bar Code
680000	17,5	6/12/48	8411922448580

CASCANUECES CLASSIC

nutcracker
casee-noix
schiaccianoci
quebra-noces



ALUMINIUM

ABS



ref.	cms.		Bar Code
738800	18	12/24	8411922093476

CASCANUECES BOLETUS

Nutcracker Boletus
Casse-noix Boletus
Nussknacker Boletus
Quebra-nozes Boletus

MADERA DE HAYA

BEECH WOOD



ref.	∅	H		Bar Code
682500	6	10	12/24	8411922455953

RASPADOR DE ESCAMAS

fish scaler
 écailleur à poisson
 fischentschupper
 raspador de escamas

INOX /
S. STEEL



ref.	cms.	H		Bar Code
705610	26	2	6/48	8411922449563

SET 6 PINCHOS PARA CARACOLES

set 6 skewers for snails
 lot 6 piques à scargots
 set 6 gabeln für schnecken
 set 6 garfos para caracóis

INOX /
S. STEEL

METALLIC

NEW



ref.	cms.		Bar Code
687000	11	6	8411922459579

ATRIL PARA LIBRO DE COCINA

cookbook stand
 pupitre pour livre de cuisine
 atril para livro de cozinha



ref.	cms.		Bar Code
728000	20x17	1/6	8411922084931

ATRIL PLEGABLE CLASS

folding book holder
 pupitre pliable
 kappbarer ständer
 atril dobrável



también para tablets
 also for ebooks or tablets



ref.	cms.	H.		Bar Code
728750	9x15	13	6/48	8411922449976

TENACILLA BARBACOA

BBQ tongs
 pince à barbecue
 tenaglia per barbecue
 tenazes para barbacoa

INOX /
S. STEEL

INOX /
S. STEEL



ref.	cms.		Bar Code
745439	34	12/144	8411922436624

TENACILLA ESTRECHA

serving tongs, wire handle
 pince étroit
 pinze de cucina, manico in filo
 pinça estreita



ref.	cms.		Bar Code
745325	25	12/144	8411922436600
745330	30	12/144	8411922436617
745335	35	12/120	8411922439748

TENAZAS

clamp
pince
tenaglia
tenaz



ref.	cms.	H		Bar Code
791125	25	4	6/48	8411922090628
791130	30	4	6/48	8411922090635
791135	35	4	6/48	8411922090642

PINZA PARA ESPINAS DE PESCADO

fish bone tweezer
pince à désarêter
pinze per rimuovere le espine del pesce
pinça para espinhas de peixe



INOX /
S. STEEL



ref.	Cms.	H		Bar Code
736700	8,5	2,4	6/360	8411922091793

PINZA UNIVERSAL

universal tong
pince universal
pinça universal



INOX /
S. STEEL

PINZA DE HIELO

ice tong
pince à glace
pinça para gelo



INOX /
S. STEEL
18%

ref.	cms.		Bar Code
706900	24,5	12/72	8411922074802

ref.	H.		Bar Code
763600	18	12/144	8411922203080

PINZA NYLON PROF

tong
pince
pinza
pinça



INOX /
S. STEEL

NYLON



ref.	cms.		Bar Code
741824	24	6/96	8411922435344
741830	30	6/96	8411922435351

PINZA

tong
pince
zange
pinça



INOX /
S. STEEL

NYLON

5 + 5 + 5 + 5 = 20

ref.	cms.		Bar Code
751123	23	20/40	8411922441857

PINZA ENSALADA

salad tong
pince à salade
pegador de salada

INOX /
S. STEEL



ref.	cms.	📦	Bar Code
716300	20	6/72	8411922073355

PINZA UNIVERSAL

universal tong
pince universal
pinça universal

INOX /
S. STEEL
18/10



ref.	H.	📦	Bar Code
761200	23,5	6/144	8411922621846

PINZAS PARA FRITURAS (BLISTER)

frying tong
pince à friture
pinça para fritos

INOX /
S. STEEL



ref.	cms.	📦	Bar Code
723200	23	6/72	8411922080810

PINZA PARA HIELO

ice tong
pince à glass
pinza ghiaccio
pinça para gelo

INOX /
S. STEEL
18/10



ref.	cms.	📦	Bar Code
732300	19	6/24	8411922086331

PINZAS ALBÓNDIGAS

meatball tongs
pince à boulette
pinça para fazer almôndegas

INOX /
S. STEEL



ref.	cms.	📦	Bar Code
708534	3,4	6/144	8411922075373
708544	4,4	6/144	8411922075380

PINZA - TIJERA REPOSTERÍA

bakery tong
pince patisserie
pinza pasticceria
pinça pastelaria

INOX /
S. STEEL



ref.	cms.	📦	Bar Code
745100	18	6/120	8411922436525

PINZA PASTELERA

cake tong
pince à gateaux
pinça para pastelaria



INOX /
S.STEEL

ref.	cms.		Bar Code
761400	19,5	12/144	8411922621860

PINZA DE JAMÓN

ham tong
pince à jambon
pinza per prosciutto
pinça para presunto



INOX /
S.STEEL

ref.	Cms		Bar Code
748900	12	6/144	8411922438550

PINZA REPOSTERÍA C/ANILLAS

bakery tong with rings
pince patisserie avec anneaux
pinza pasticceria con anello
pinça pastelaria com anilhas



INOX /
S.STEEL

ref.	cms.		Bar Code
744300	17	6/144	8411922436310

PINZA SERVICIO CON MUELLE

spring serving tongs
pince service à ressort
pinza a molla per servire
pinça de servir com mola



INOX /
S.STEEL

ref.	cms.		Bar Code
745000	20	6/120	8411922436518

PINZA DE PRECISIÓN CURVA

chef's curve tongs
pince de chef coudée
gebogene küchenzange
pinça de chef curva



INOX /
S.STEEL

ref.	cms.		Bar Code
741016	16	6/144	8411922448986
741021	21	6/144	8411922448993

PINZA DE PRECISIÓN

precision tong
pince de précision
pinzetta di precisione
pinça de precisão



INOX /
S.STEEL

ref.	Cms		Bar Code
740800	17	6/144	8411922435092
740821	21	6/144	8411922438581
740830	30	6/72	8411922449006

PINZA PERFORADA

perforated tongs
pince perforée
zange perforiert
pinça perfurada



INOX /
S.STEEL

ref.	cms.		Bar Code
716410	22	6	8411922451023

PINZA PARA HORNO

oven tongs
pince pour four
pinza per teglie da forno
Pinça para forno

INOX /
S. STEEL
18/10

SILICONE

max. 220°C



ref.	cms.		Bar Code
741900	19	6/72	8411922435337

PINZA PARA PLATOS CALIENTES

Clip for hot dishes
Pince pour plats chauds
Zange für heiÙe Teller
Pinça para pratos quentes

INOX /
S. STEEL
18/10

SILICONE



ref.	Cms		Bar Code
763150	18	6/36	8411922456325

ROMPEMARISCO + 2 TENEDORES MARISCO (BLISTER)

seafood cracker + 2 seafood forks
pince à fruit de mer + 2 curettes à homard
quebra-marisco + 2 garfos de marisco

INOX /
S. STEEL



ref.	cms.		Bar Code
781400	18/24	6/24	8411922082494

TENAZA PARA MARISCO + 4 TENEDORES

Set of a lobster cracker and four forks
Ensemble composé d'une pince à crustacés et de 4 fourchettes à fruits de mer
Set mit einer Zange und 4 Gabeln für Meeresfrüchte
Conjunto de tenaz e 4 garfos para marisco

INOX /
S. STEEL



ref.	Cms.		Bar Code
684900	18+20,5	6	8411922458022

TENAZA ROMPEMARISCO (BLISTER)

seafood cracker
pince à fruit de mer
quebra-marisco

INOX /
S. STEEL



ref.	cms.		Bar Code
781500	18	6/12	8411922082500

ROMPEMARISCO CON MUELLE / CASCANUECES

seafood cracker / nutcracker
pince à fruit de mer / casse noix
quebra-marisco / quebra-noces

CROMADO

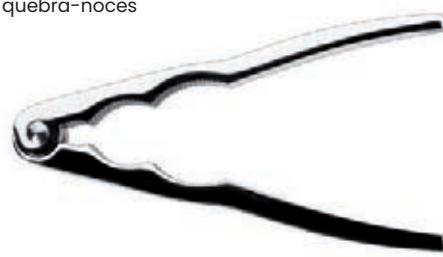

ref.		Bar Code
785800	12/24	8411922085242

BOLSA PARA COCIDO

stewing bag
sac pour pot-au-feu
borsa per bollire
saco para cozer

libili DESIGN

(copyright)



max. 240°C min. -40°C



Para cocer legumbres, pastas, arroz, cereales, verduras o carnes por separado. Fácil de limpiar y guardar.

Can be used for cooking legumes, pasta, rice, grains, vegetables or meat separately. Easy to clean and storage.

ref.	Cms	H		Bar Code
749300	12x12	15	1/6/36	8411922438499

BOLA PARA COCIDO

Cooking ball
Boule pour pot-au-feu
Kochkugel für eintopf
Esfera para cozidos



ref.	Cms.		Bar Code
768414	14,5	6/24	8411922209006

CESTILLO PLEGABLE LUXE

collapsible steamer basket
panier pliable
klappbarer korb
cesto para cozinhar a vapor



ref.	Ø	H.		Bar Code
796127	27	8	6/48	8411922447132

CESTILLO DE VAPOR PLEGABLE

steam basket
panier vapeur
cestello a vapore
cesto de vapor



ref.	cms.		Bar Code
786922	16-24	6/48	8411922087598

BOLA-MALLA PARA ESPECIAS

flavoring mesh
boule à épices
bola para condimentos



ref.	cms.		Bar Code
779510	11	6/48	8411922081893

ROCIADOR DE SALSAS

sauce baster
poire à sauce
pulverizador de molhos



INOX /
S. STEEL



ref.	cms.	lts.		Bar Code
777510	26	0,15	6/48	8411922080261

INECTOR DE SALSAS

sauce syringe
seringue à sauce
injector de molhos



PLASTIC



ref.	Cms.	ml.		Bar Code
777500	23	44	6/48	8411922080254

ASADOR PORTAESPECIAS PARA POLLO

chicken roast stand with infuser
rôtissoire à poulet aux épices
cuoci pollo con infusiera spezie
assador de frango con especiarias



INOX /
S. STEEL

Con receta
With recipe
Avec recette
Con ricetta
Com receita



ref.	cms		Bar Code
731400	15x12	1/6	8411922086119

BOLSAS PARA ASAR

oven roasting bags
sacs de cuisson
sacos para assar



PLASTIC

~~BPA~~



max. 200°C

ref.	cms.		Bar Code
753700	38x25	12/48	8411922085099

BOLSAS PARA GRILL & TOSTADORA (2 uds)

bags for grill & toasters
sachets grill & croques
sacos para grelhador & torradeira

PLASTIC

~~BPA~~

max. 260°C
min. -80°C

ref.	cms.		Bar Code
778900	24,5x17,5	24/24	8411922081190



MALLA ELÁSTICA PARA CARNE

elastic meat netting
filet élastique
rede para carne



ref.	cms.		Bar Code
777702	200	6/6	8411922080308

HILO ALIMENTARIO PARA MATANZAS

sausage ties
ficelle alimentaire pour bardage
küchengarn für wurstwaren
fio alimentar para chacina



ref.	m.		Bar Code
730710	250	1/6	8411922448252

HILO DE COCINA (60 M)

kitchen string
fil de cuisine
fio de cozinha

RAYON



ref.	Cms.		Bar Code
771200	600	12/144	8411922077827

HILO DE COCINA CON DISPENSADOR

kitchen string with dispenser
fil de cuisine avec distributeur
fio da cucina con dispenser
fio de cozinha com dispensador

RAYON



ref.	Cms.		Bar Code
795500	600	12/72	8411922093643

MALLA PARA LEGUMBRES

net bag for legumes
sac à légumes
gemüsenetz
saco de legumes

NYLON



ref.	Cms.		Bar Code	
779000	37x20	6/6	8411922081206	2Kg
779010	37x30	6	8411922446555	4Kg

PAÑO PARA QUESO

cheesecloth
chiffon à fromage
panno per formaggio
pano para queijo

paño 770mc



ALGODÓN
COTTON

TEXTILES DE CONFIANZA
Control de sustancias nocivas según Oeko-Tex® Standard 100
2013OK0209 AITEX



max. 60°C

ref.	cms.	📦	Bar Code
746400	50x50	6/6	8411922436853

TELA DE ESTAMEÑA

muslin cloth
tissu étamine
stoffa stamigna
tela de gaze

paño 358mc



ALGODÓN
COTTON

TEXTILES DE CONFIANZA
Control de sustancias nocivas según Oeko-Tex® Standard 100
2013OK0209 AITEX



max. 60°C

ref.	cms.	📦	Bar Code
746450	50x50	6/6	8411922436860

SACO PARA JAMON

ham bag
sac à jambon
saco para presunto



ref.	cms.	📦	Bar Code
777609	90	6/6	8411922080292

SET 2 FUNDAS PARA RODILLO DE AMASAR

set 2 rolling pin covers
set 2 couvre-rouleaux a patisserie
2 teigrollenhüllen
conjunto de 2 capas para rolo de amasar

POLYESTER

ALGODÓN
COTTON



ref.	cms.	📦	Bar Code
746650	38	6/96	8411922451658

BOLSA FILTRO PARA LECHE VEGETAL

Bag for plant milk
Sac pour lait végétal
Pflanzenmilchbeutel
Saco para leite vegetal



Todo tipo de frutos secos, cereales y semillas
All types of nuts, cereals and seeds



ALGODÓN
COTTON



ref.	Cms	📦	Bar Code
706550	25,5X34	6	8411922456400

MOLDE HAMBURGUESA LUXE

hamburger maker
 moule hamburger
 hamburgerform
 forma hambúrguer

ALUMINIUM



ref.	Ø	📦	Bar Code
748000	11	6/24	8411922437638

MOLDE HAMBURGUESA - REDONDO

round hamburger maker
 moule à steak haché rond
 hamburgerform
 forma hambúrguer redonde



PLASTIC



ref.	cms.	📦	Bar Code
777201	11	1/6	8411922080186

MOLDE HAMBURGUESA - CUADRADO

square hamburger maker
 moule à steak haché carré
 hamburgerform
 forma hambúrguer quadrado

PLASTIC



ref.	cms.	📦	Bar Code
777200	8,5	1/6	8411922080179



MOLDE HAMBURGUESA

hamburger maker
 moule hamburger
 hamburgerform
 forma hambúrguer

ALUMINIUM



ref.	Ø	H	📦	Bar Code
748001	6	8	6	8411922454635
748002	9	8	6	8411922454642

A
 B

MOLDE NIDO

bird's nest mould
panier à nid
forma ninho

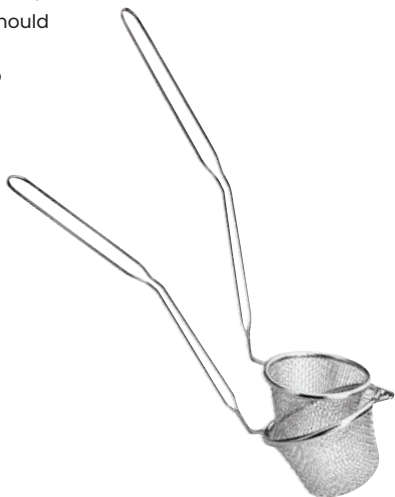

INOX /
S. STEEL
18/10

ref.	cms.		Bar Code
706300	8,5+10	6/72	8411922076264

COCEDOR PASTA / ESPÁRRAGOS MANGO ABATIBLE

cozedor para massa e aspargos
pasta & asparagus strainer
cuiseur pour pâtes et asperges
nudel- und spargelkocher

ibili Design

INOX /
S. STEEL



ref.	Ø	H.		Bar Code
758510	13	14,5	1/6	8411922447033

MINI CESTILLO REDONDO

round mini basket
mini panier ronde
mini cestino tondo
mini cesto redondo



INOX /
S. STEEL

ref.	Ø	H.		Bar Code
751910	9	7,5	12/48	8411922093780

MINI CESTILLO RECTANGULAR

oblong mini basket
mini panier rectangulaire
mini cestino rettangolare
mini cesto rectangular



INOX /
S. STEEL

ref.	cms.		Bar Code
751900	9x10,5	12/48	8411922093773

CUBO MINI

bucket mini
seau mini
secchio mini
balde com asa mini



INOX /
S. STEEL

ref.	Ø	H.		Bar Code
711807	7	7	6/6	8411922434057
711809	9	8,5	6/6	8411922434064
711810	10	10	6/6	8411922434071

PINZA PARA TARROS DE CONSERVA

Clip for preserving jars
Pince à bocaux
Zange für Einmachgläser
Pinça para frascos de conservas

PLASTIC

INOX /
S. STEEL



ref.	cms.		Bar Code
684400	22x8	6/48	8411922457421

EMBUDO PARA CONFITURAS

cone for jams
entonnoir pour confitures
imbuto per confetture
funil para compotas

INOX /
S. STEEL
18/10



ref.	cms.		Bar Code
739614	5,5-14	6/6	8411922433715

EMBUDO CON FILTRO

funnel with strainer
entonnoir filtre
funil com filtro

INOX /
S. STEEL
18/10

SILICONE



ref.	cms.		Bar Code
763800	10	6/72	8411922203103

EMBUDO

funnel
entonnoir
funil



ref.	Ø		Bar Code
744600	9,5	6/144	8411922436471

CORTAHUEVOS

egg slicer
coupe-œuf
taglia uova a fette
laminador de ovos

PLASTIC

INOX /
S. STEEL



ref.	cms.		Bar Code
790500	14x8	6/72	8411922090529

CORTAHUEVOS

egg slicer
coupe-œuf
taglia uova a fette
laminador de ovos

INOX /
S. STEEL
18/10



ref.	cms.		Bar Code
769800	14,5x8,5	12/144	84119220161328

PERFORADOR DE HUEVOS

egg piercer
perceur d'œufs
eierstecher
perforador de ovos

NEW

Evita que se agriete en la cocción y ayuda a pelarlo
Prevent from cracking during boiling and makes the egg easier to peel

PLASTIC



ref.	Ø	H		Bar Code
687800	6	2,5	6/144	8411922460117

CORTADOR/LAMINADOR DE HUEVOS Y CHAMPIÑONES

Multi-slicer for eggs & mushrooms
Multi-slicer pour couper œufs et champignons
Multi slicer dazu geeignet, Eier, Pilze
Multi slicer para cortar ovos e cogumelos

PLASTIC

INOX / S. STEEL

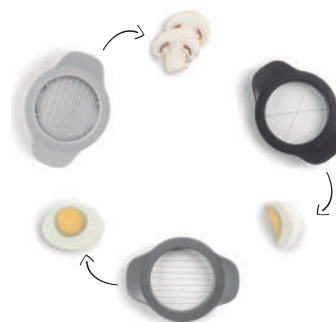
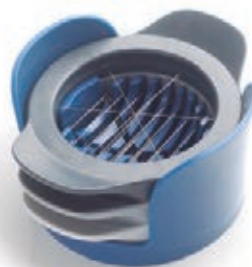

ref.	Ø	Cms		Bar Code
763450	6,5	11	6/48	8411922456332

ABLANDADOR DE CARNE

meat tenderizer
attendriseur à viande
amaciador de carne

PLASTIC



ref.		Bar Code
728200	6/72	8411922084955

SET 4 UTENSILIOS PARA DECORAR CALABAZAS

set of 4 pumpkin decorating utensils
set de 4 ustensiles pour décorer les citrouilles
4er-werkzeugset zum dekorieren von kürbissen
conjunto de 4 utensilios para decorar abóboras

PLASTIC

INOX / S. STEEL 18/10



A: Sierra / Saw
B: Punzón / Carving tool
C: Cuchara / Scoop
D: Vaciador / Baller



ref.		Bar Code
721700	6/48	8411922448931

DESHUESADOR PARA CEREZAS Y ACEITUNAS

Cherry and Olive Pitter
 Désosseur pour cerises et olives
 Entsteiner für Kirschen und Oliven
 Descaroador para cerejas e azeitonas



ref.	Cms		Bar Code
686300	18,5	6/48	8411922459210

PRENSADOR PARA AJOS

Garlic Press
 Presse-ail
 Knoblauchpresse
 Prensador para alhos



ref.	Cms.		Bar Code
686400	16	6/48	8411922459227

PELADOR DE AJOS

garlic peeler
 épiluche-ail
 descascador de alho



ref.	cms.		Bar Code
726800	7x5	12/96	8411922083682

PELAAJOS ECO

garlic peeler
 épiluche-ail
 descascador de alho



ref.	Cms.		Bar Code
707900	14	12/120	8411922074918

PICADOR DE AJO

garlic chopper
 hachoir de l'ail
 aglio chopper
 picador de alhos



ref.	Ø		Bar Code
750000	7	6/54	8411922439090

PRENSADOR PARA AJOS

Garlic Press
 Presse-ail
 Knoblauchpresse
 Prensador de alhos



ref.	Cms.	H		Bar Code
681900	10	7	6/72	8411922455601

GUÍA CORTACEBOLLAS

onion holder
pique découpe-oignons
guía cortacebolas



ref.	cms.		Bar Code
724200	13	6/60	8411922082074

PROTECTOR DE DEDOS

finger shield
protecteur de doigts
protector de dedos

INOX /
S. STEEL
18/10



ref.	cms.		Bar Code
787900	6,5x6	6	8411922088090

CEPILLO PARA VERDURAS

vegetables brush
brosse à laver légumes
cepillo para verduras

PLASTIC



ref.	cms.		Bar Code
783300	6 x 8	6/24	8411922083316

REPOSAUTENSILIOS

Utensil holder
Repose-ustensiles
Kochlöffel-Ständer
Base para pousar utensilios

SILICONE



ref.	cms.		Bar Code
685350	13,7X13,5	6/36	8411922458268

REPOSACUCHARAS

support for spoon
support pour cuillère
supporto per cucchiaino
descanso para colher

INOX /
S. STEEL



ref.	cms.		Bar Code
743700	22x10	6/48	8411922436150

REPOSA UTENSILIOS CON CUCHARA

tool stand with spoon
repose ustensiles
pousa utensilios

INOX /
S. STEEL
18/10



ref.	cms.	H.		Bar Code
769000	9,5	17,2	1/24	8411922209457

GAFAS PARA CORTAR CEBOLLA ECO

onion goggles
lunettes pour couper les oignons
ochiali di protezione per tagliare le cipolle
óraculos para cortar cebolla

PLASTIC



*Se acabó el llorar
For tear free
Finies les larmes
Não chore mais*

ref.		Bar Code
796600	6/60	8411922093827

PELADOR DE ESPÁRRAGOS

asparagus peeler
éplucheur d'asperges
pela asparagi
descascador de espargos

loli design



INOX / S.STEEL

Profesional/Profesional



ref.	Cms		Bar Code
753500R	25	6/48	8411922439205

PIEDRA DE AFILAR COMBINADA

sharpening stone
pierre à aiguiser
schleifstein
pedra de afiar

CORUNDUM

GR400
GR1000

NEW

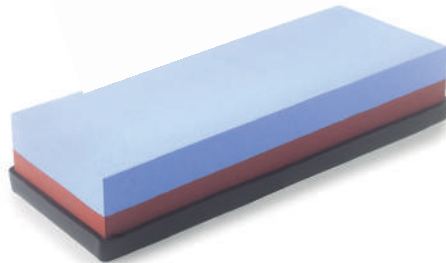

ref.	Cms	H		Bar Code
688200	16x6	3,2	1/6/12	8411922470369

AFILADOR COMPACTO

Compact Sharpener
Aiguiser Compact
Kompaktes Schleifgerät
Afiador Compacto

INOX / S.STEEL

ABS

2 piedras (fina y gruesa)
2 stages (fine & coarse)



*Con ventosa
with suction cup*

ref.	cms.	H		Bar Code
718210	6	6	6/48	8411922448924

AFILADOR MINI

sharpener mini
aiguiser mini
affilacoltelli mini
afiador mini

INOX / S.STEEL

ABS

Piedra de cerámica y diamante
Diamond and ceramic sharpener
Pierre en céramique et diamant
Pedras de cerâmica e diamante



ref.	cms.		Bar Code
796200	10x6	12/24	8411922093735

AFILADOR PROFESIONAL 7 USOS

knife sharpener 7 usage
aiguiseur de couteaux 7 utilisations
messerchärfer 7 funktionen
afilador de facas 7 tipos de afiação

INOX /
S. STEEL

ABS

NEW



1. Ranura gruesa / Coarse Slot
2. Ranura media / Medium Slot
3. Ranura fina / Fine Slot
4. Ranura para cuchillos dentados / Serrated knife slot
5. Ranura para cuchillos de cerámica / Ceramic knife slot
6. Ranura para cuchillos de un solo filo / Single-edged knife slot
7. Afilar las tijeras / Sharpening for Scissors

ref.	Cms	H		Bar Code
783770	23	9,5	1/6/36	8411922459838

AFILADOR DE CUCHILLOS DE COCINA

kitchen knife sharpener
aiguiseur de couteaux de cuisine
afiador de facas de cozinha

INOX /
S. STEEL

ABS



Piedra de cerámica y diamante
Diamond and ceramic sharpener
Pierre en céramique et diamant
Pedras de cerámica e diamante

ref.	cms.		Bar Code
783700	20	1/9	8411922083989

AFILADOR DE CUCHILLOS Y TIJERAS

knife and scissors sharpener
aiguiseur de couteaux et ciseaux
afilatore di coltello e forbice
afiador de facas e tesouras

INOX /
S. STEEL

ABS



ref.	cms.		Bar Code
783750	20	1/12/48	8411922435139

AFILADOR PLEGABLE

folding knife sharpener
aiguiseur pliant
klappbarer messerschäfer
afiador dobrável

INOX /
S. STEEL

ABS

Cerámica
Ceramic

Carburo
Carbide

Diamante
Diamond



ref.	cms.	H		Bar Code
783760	14x4	4,5	1/12/48	8411922448795

PELADOR 3 CUCHILLAS

peeler 3 blades
 éplucheur 3 lames
 descascador 3 lâminas



ref.	cms.		Bar Code
728600	12/96		8411922085044

PELATATAS "Y" CONFORT

potato peeler
 éplucheur à legumes
 pelapatate
 descascador de batatas



ref.	cms.		Bar Code
791400	15x7	24/96	8411922090833

PELATATAS RECTO CLASIC

peeler
 éplucheur
 pelapatate
 descascador



ref.	cms.		Bar Code
742800	17	24/48	8411922435573

PELADOR DE CALABAZA

pumpkin peeler
 eplucheur à citrouilles
 pela zucca
 descascador de abóbora



INOX / S. STEEL

ref.	Cms		Bar Code
749600	17x10	6/72	8411922438796

PELATATAS

potato peeler
 éplucheur à legumes
 pelapatate
 descascador de batatas



INOX / S. STEEL

ref.	Cms		Bar Code
749000	11	30/120	8411922438529

PELATOMATES

tomato peeler
 épilucheur à tomate
 pela pomodoro
 descascador de tomate



PLASTIC

INOX / S. STEEL



ref.	Cms		Bar Code
794000	15x7	24/24/96	8411922093445

PELATOMATES

tomato peeler
 épilucheur à tomate
 tomatenschäler
 descascador de tomate



INOX / S. STEEL



ref.	Cms		Bar Code
749050	11x5	30/120	8411922452730

SET 3 PELADORES

Set of 3 peelers
 Ensemble 3 épilucheurs
 3-Teiliges schälmesser-set
 Conj. 3 Descascadores



PLASTIC

INOX / S. STEEL



ref.	cms.		Bar Code
686200	13	6/60	8411922459203

SACAPUNTAS DE VERDURA GRANDE

large vegetable sharpener
 grand taille-légumes
 temperino per verdure grande
 afia-legumes grande

PLASTIC

INOX / S. STEEL



ref.	Cms		Bar Code
723150	7x8	6/72	8411922093742

SACAPUNTAS DE VERDURAS

vegetable sharpener
 taille-pointe pour légumes
 saca-pontas para verduras

PLASTIC

INOX / S. STEEL



ref.	cms.	H.		Bar Code
723100	15,5	4	6/72	8411922080803

CORTAPIZZAS CONFORT

pizza cutter
roulette à pizza
tagliapizza
corta-pizzas



ref.	cms.		Bar Code
739000	18	12/48	8411922093483

PELATATAS CONFORT

potato peeler
éplucheur à légumes
pelapatate
descascador de batatas



PLASTIC

INOX / S. STEEL

ref.	cms.		Bar Code
739001	15	12/48	8411922093490

ABRELATAS + ABREBOTES + ABRECHAPAS CONFORT

tin opener + bottle opener + cap remover
ouvre-boîtes + tire-bouchons + ouvre-bouteilles
aprilattine + apribottiglie + apriscatole
abre-latas + abre-garrafas + tira-cápsulas



3 en 1

ref.	cms.		Bar Code
739002	14	12/48	8411922093506

PELADOR BASIC

potato peeler Basic
éplucheur à légumes Basic
schäler Basic
descascador de batatas Basic



INOX / S. STEEL

ref.	cms.		Bar Code
680600	16	24	8411922454390

CUCHILLO PARA OSTRAS

oyster knife
couteau à huîtres
austernmesser
faca para ostras



INOX / S. STEEL

ref.	cms.		Bar Code
681100	16,5	6/48	8411922454468

CORTADOR ONDULADO

wavy vegetable slicer
coupe-légumes ondulé
taglia-verdure smerlato
cortador ondulado
para verduras

INOX /
S. STEEL



ref.	cms.	H		Bar Code
729900	8	10	6/288	8411922086140

CORTADOR/PELADOR JUDIAS VERDES

french style bean slicer
effileur pour haricots
utensile per tagliare/pelare i fagiolini
cortador/descascador de feijão verde

PLASTIC



ref.	cms.		Bar Code
799700	13	12/360	8411922434538

CORTAPIZZAS PROFESSIONAL

pizza cutter
roulette à pizza
pizza-scheider
corta-pizzas

INOX /
S. STEEL



ref.	cms.	Ø		Bar Code
680800	15	10	6	8411922454413

CORTAPIZZA

pizza cutter
roulette à pizza
cortapizza em

INOX /
S. STEEL
18/10



ref.		Bar Code
761900	12/144	8411922621914

CORTA PIZZA

pizza cutter
roulette à pizza
tagliapizza
corta-pizzas

INOX /
S. STEEL

PLASTIC



ref.	cms.	H		Bar Code
733400	8	11	12/72	8411922086836

DECORADOR GUIRNALDA

Garland decorating tool
Decò guirlande
Dekorateur für Girlande
Cortador guirnalda

INOX /
S.STEEL

PROFESIONAL

2 medidas
2 sizes



Zanahoria-carabacín
Carrots - zucchini



ref.	cms.		Bar Code
779750	17	6/240	8411922457827

DECORADOR ESPIRAL DOBLE

double spiral decorating
decò spiral double
cortador espiral doble

PLASTIC

INOX /
S.STEEL



ref.	cms.		Bar Code
779200	16	6/144	8411922081855

DECORADOR GUIRNALDA

garland decorating tool
decò guirlande
cortador guirnalda

PLASTIC

INOX /
S.STEEL



ref.	cms.		Bar Code
779700	12	6/72	8411922081947

PICADOR ECO

chooper
hachoir
tritituto
picador

INOX /
S.STEEL

PLASTIC



ref.	Cms		Bar Code
799600	23	10	1/6 8411922434330

PICADORA

chopper
hachoir
zerkleinerer
picadora

INOX /
S.STEEL

PLASTIC



ref.	Ø	H.		Bar Code
768910	8	23	1/6/48	8411922448115

PICADOR MAXI CONFORT

chooper maxi confort
hachoir maxi confort
tritatore maxi confort
picador maxi confort

SILICONE PLASTIC INOX / S. STEEL



ref.	Cms.	Ø		Bar Code
799510	23	8,7	1/6/24	8411922434323

Salades

FUERTE, RESISTENTE Y FUNCIONAL
STRONG, RESISTANT AND FUNCTIONAL
ROBUSTE, RÉSISTANTE ET FONCTIONNELLE
FUERTE, RESISTENTE E FUNCIONAL

PLASTIC

CENTRIFUGADORA DE ENSALADA ESSENTIAL

salad spinner essential
essoreuse à salade essential
centrifugadora de salada essential



Con freno
With brake
Dispos d'un frein
Con travao

Antideslizante
Non-slip
Antiglisse
Anti-deslizante

ref.	cms.		Bar Code
783620	20	1/6	8411922083828
783626	26	1/6	8411922083835

CENTRIFUGADORA DE ENSALADA A PEDAL FUNCTION

salad spinner via pedal
essoreuse à salade à pédale
centrifugadora de salada a pedal



ref.	cms.		Bar Code
783016	16	1/6	8411922083279
783024	24	1/6	8411922083286



CENTRIFUGADORA ENSALADAS CONFORT

salad spinner confort
essoreuse à salade confort
centrifuga per insalata confort
centrifugadora de salada confort

A manivela
Via crank
À manivelle
Com manivela

Antideslizante
Non-slip
Antiglisse
Anti-deslizante



ref.	cms.		Bar Code
783120	20	1/6	8411922434309
783124	24	1/6	8411922083293

SET 6 ESPECIEROS + SOPORTE GIRATORIO

set of 6 rotating spice jars

présentoir à épices 6 pots à support rotatif

6 gewürzstreuer

conjunto de 6 frascos de especiarias giratório

PLASTIC



ref.	Ø	H		Bar Code
797710	18	21,5	1/6/12	8411922441598

MOLINILLO DE PIMIENTA MINI

pepper grinder

moulin à poivre

macinapepe

moinho de pimenta

ALUMINIUM



ref.	Ø	H.		Bar Code
790400	3	15	6/60	8411922090512

MOLINILLO DE PIMIENTA / SAL ELECTRICO

electric pepper / salt grinder

moulin à poivre / sel électrique

moinho de pimenta / sal eléctrico

INOX / S. STEEL



included



ref.	cms.		Bar Code
778600	22	6/30	8411922081008

MOLINILLO DE PIMIENTA

pepper grinder

moulin à poivre

macinapepe

moinho de pimenta

CERAMIC GRINDER



ref.	Cms.		Bar Code
773416	15	1/6	8411922078121
773421	20	1/6	8411922078138
773431	30	1/6	8411922078145

MOLINILLO DE PIMIENTA

pepper grinder

moulin à poivre

macinapepe

moinho de pimenta

CERAMIC GRINDER



ref.	Cms.		Bar Code
773316	15	1/6	8411922078077
773321	20	1/6	8411922078084
773331	30	1/6	8411922078107

MOLINILLOS DE PIMIENTA

pepper grinder
moulin à poivre
pfeffermühle
moinho de pimenta

MADERA
WOOD



ref.	cms.	H	📦	Bar Code
773216	15	16	1/6/24	8411922441543
773221	20	22	1/6/24	8411922441550
773231	30	31	1/6/24	8411922441567

MOLINILLOS DE PIMIENTA NEGRO

pepper grinder
moulin à poivre
pfeffermühle
moinho de pimenta

MADERA
WOOD

CERAMIC
GRINDER



ref.	cms.	H	📦	Bar Code
774516	16	16	1/6/24	8411922449877
774521	20	22	1/6/24	8411922449884
774531	30	31	1/6/24	8411922449891

MOLINILLO PIMIENTA TRANSPARENTE

pepper grinder
moulin à poivre
pfeffermühle
moinho de pimenta

PMMA

CERAMIC
GRINDER



ref.	H	Ø	📦	Bar Code
683414	14	5,5	1/6/24	8411922456998
683416	16	5,5	1/6/24	8411922457001
683418	18	5,5	1/6/24	8411922457018

CLIP MAGNÉTICO PARA BOLSAS (4 PCS)

magnetic bag clip (4pcs)
pince à aimant pour sacs (4pcs)
magnet-beutelclips (4pcs)
clipe com íman para sacos (4pcs)

~~BPA~~

INOX /
S. STEEL

PLASTIC



ref.	Cms	📦	Bar Code
717700	7,5	6/96	8411922448627



CLIP PARA BOLSAS (4PCS)

bag clip (4pcs)
clip pour sachets (4pcs)
beutelclip (4pcs)
clipe para bolsas (4pcs)

~~BPA~~

PLASTIC



ref.	Cms	📦	Bar Code
717800	9	6/288	8411922448900

PINZAS SUJETAMANTEL (4 Pzs)

table cloth clip (4 pzs)
pince à nappe (4 pzs)
tischdeckenklammer (4 pzs)
pinça sujeita-toalhas (4 pzs)

INOX /
S. STEEL



ref.	cms.	📦	Bar Code
725100	5x4	6/144	8411922448597

MANO PARA MORTERO

Pestle for mortar
Pilon pour mortier
Stößel für Mörser.
Pistilo para almofariz



MADERA
DE HAYA

BEECH
WOOD

UNIVERSAL

ref.	Cms.		Bar Code
684500	19	6/36	8411922457865

MORTERO

Mortar
Mortier
Mörser
Almofariz

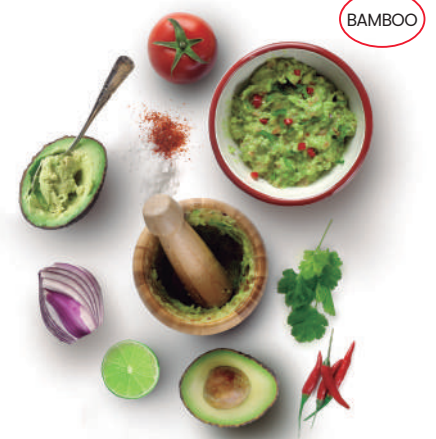

BAMBOO

ref.	Ø	H		Bar Code
752050	10	11x10	6/12	8411922456530

MORTERO

mortar
mortier
mörser
almofariz



MÁRMOL
MARBLE

No poroso e higiénico.
Non porous and hygienic

ref.	Cms	H		Bar Code
780310	12	12	1/4	8411922444063

MORTERO

mortar
mortier
mörser
almofariz

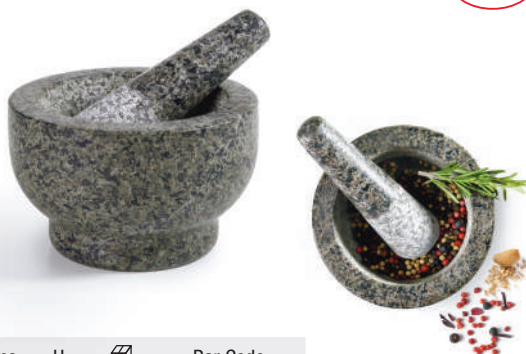

GRANITE

MORTERO

mortar
mortier
almofariz



INOX /
S. STEEL

ref.	Cms	H		Bar Code
780410	13	8	1/6	8411922444070

ref.	cms.		Bar Code
722600	13,5x7,5	1/6	8411922080209

SET DE 2 COLGADORES DE TPAOS

set of 2 dish rag holders
lot de 2 porte-torchons
saughaken, 2 stück
2 suportes para pendurar panos

PLASTIC



ref.	Ø	📦	Bar Code
681200	5	6/144	8411922454475

BOLSAS ECO PARA FRUTA Y VERDURA

polyester bags
sacs en polyester
polyesterbeutel
sacos de poliéster

REUTILIZA & RECICLA / REUSE & RECYCLE

PET

LIGERA Y TRANSPIRABLE / LIGHT & BREATHABLE

6u. 2 x (20 x 30 cm)
2 x (30 x 35 cm)
2 x (30 x 43 cm)



ref.	📦	Bar Code
702310	6/48	8411922453324

MANOPLA REFORZADA

reinforced glove
gant renforcé
verstärkter topfhandschuh
manopla reforçada

ALGODÓN COTTON POLYESTER



NEW



ref.	cms	📦	Bar Code
706850	31x20	6/48	8411922452082

Flexiform

FLEXIFORM
100% SILICON

max. 230°C min. -60°C

MANOPLA

oven glove silicone
gant silicone
manopla silicone

H.A.C.C.P.
NO PROBLEM

Sanitariamente garantizado
Pure silicon construction for
Apto para uso culinário
Hygiène garantie
healthy cooking

CE

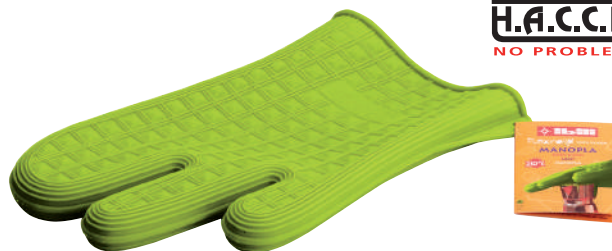

ref.	cms.	📦	Bar Code
765800	27x14	6/48	8411922208917

SALVAMANTEL CUADRADO/REDONDO

tablemat
dessous de plat
sottopentola in silicone
descanso de prato

3 GREEN
+
3 PURPLE

SILICONE



ref.	Cms.	📦	Bar Code
776900	16X16	6/24	8411922088014

CUBO PARA RECICLAJE

recycling bin
poubelle pour tri sélectif
recycling-treimer
balde para reciclagem

METALLIC

Cuerpo metálico. Cubo interior plástico extraíble.
Metallic body. Removable plastic inner bucket.



ref.	Lts.	Cms.	H	📦	Bar Code
796711	1x8	29x17	40	1/4	8411922453683
796721	1x15	34x20	46	1/3	8411922453690

EMBUDO PARA RECICLAJE DE ACEITE DOMÉSTICO

funnel for recycling domestic oil
entonnoir pour le recyclage de l'huile domestique
funil para reciclagem de óleo doméstico

PLASTIC



- * El embudo se adapta a las botellas de plástico de refresco y agua
- * The funnel adapts to plastic soft drink and water bottles
- * L'entonnoir s'adapte aux bouteilles en plastique des boissons
- * O funil adapta-se as garrafas de plástico de refresco e água



1
2
3
4

Guarde el tapón
Keep the cap
Gardez le bouchon
Guarde o tãmpao



ref.	Cms	📦	Bar Code
781900	10x9	12/12	8411922082791

DISPENSADOR PARA AGUA

Water dispenser
Distributeur d'eau
Wasserspender
Dispensador de água

Con solo un toque
Just one touch



CABLE USB
USB CORD

INOX /
S. STEEL

PLASTIC



ref.	Ø	H		Bar Code
723650	7,2	13	1/6/24	8411922455366

ESPONJA DE ESMERIL PARA CACEROLAS Y SARTENES

Emery sponge for casseroles and frying pans
Éponge en émeri pour casseroles et poêles
Scheuerschwamm für töpfe und pfannen
Espanja de esmeril para caçarolas e sartãs

ESMERIL
EMERY

Perfecta para recuperar/limpiar utensilios metálicos.
Perfect for cleaning/recovering metal utensils.



ref.	Cms	H		Bar Code
682400	10x7	2,5	6/48	8411922455946

DISPENSADOR DE DETERGENTE LÍQUIDO CON SOPORTE

liquid-detergent dispenser with holder
distributeur de détergent liquide avec support
spülmittelspender mit halter
dispensador de detergente líquido com suporte

PLASTIC

incluye estropajo-esponja
includes scourer-sponge



ref.	Cms		Bar Code
680500	16x7	6/24	8411922449792

CEPILLO PARA FREGADERO

sink brush
brosse à vaisselle
spülbürste
escova para a pia

PLASTIC

Permite limpiar vajilla, ollas, fuentes de horno etc con manchas resistentes con mayor facilidad y rapidez.
Enables you to remove stubborn stains from dishes, pots, oven dishes, etc. more quickly and easily



ref.	Cms		Bar Code
680400	24	6/24	8411922449785

CEPILLO PARA CACEROLAS C/DISPENSADOR DE JABÓN

cleaning brush for pots with dispenser
brosse pour nettoyer les casseroles avec distributeur de savon
spazzolino pulisci stoviglie con dosatore di sapone
escova limpadora para panelas com dispensador de sabão



PLASTIC



ref.	cms.		Bar Code
735800	10x8,5	12/72	8411922089127

RASQUETA VITROCERAMICA

vitroceramic scraper
racloir vitroceramique
raspador vitrocerâmica



INOX /
S. STEEL
18/10

REPUESTOS RASQUETA VITROCERÁMICA (BLISTER 3 PC.)

recharge blades for vitroceramic scraper (blister 3 ps.)
lames de rechange pour racloir vitroceramique (blister 3 ps.)
reposito raspador vitrocerâmica (blister 3 ps.)

INOX /
S. STEEL



ref.	Cms.		Bar Code
708200	13	6/72	8411922074970

ref.		Bar Code
708250	24/144	8411922081961

ENCENDEDOR DE GAS*

gas lighter
allume gaz
isqueiro de cozinha a gás

CONTIENE GAS



* SÓLO CONTINENTE
ONLY MAINLAND

ref.	Cms.		Bar Code
772100	18	6/24	8411922078015

PRENSA LATAS "RECYCLE"

can crusher "Recycle"
compacteur de boîtes "Recycle"
prensa-latas "Recycle"



ref.		Bar Code
777400	1	8411922080247

GUARDA-TOMATES

tomato saver
boîte conservation tomates
contenitore per pomodoro
guarda-tomates

PLASTIC



ref.	cms.	H	📦	Bar Code
782501E	11	8	6	8411922083743

GUARDA-LIMONES

lemon saver
boîte conservation citrons
contenitore per limone
guarda-limões

PLASTIC



ref.	cms.	H	📦	Bar Code
782500E	9	11	6	8411922083736

GUARDA-CEBOLLAS

onion saver
boîte conservation oignons
contenitore per cipolla
guarda-cebolas

PLASTIC

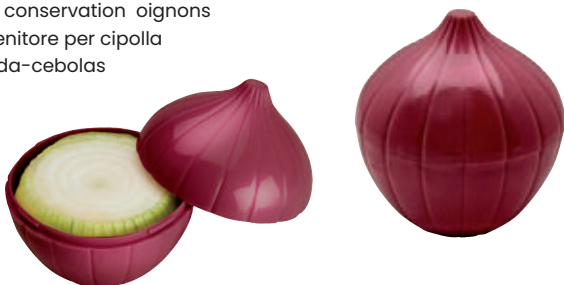

ref.	cms.	H	📦	Bar Code
782502E	11	12	6	8411922083750

PROTECTOR PARA AGUACATE

avocado saver
récipient de conservation pour avocat
avocado-box
protetor para abacate

PLASTIC



ref.	Cms	📦	Bar Code
782505	10x12	6/24	8411922449778

TABLA DE CORTE

cutting board
planche à découper
schneidebrett
tábua para cortar

BAMBOO



ref.	Cms	H	📦	Bar Code
743028	28x20	1,5	6	8411922453584
743033	33x23	1,5	6	8411922453591
743040	39,5x28	1,5	6	8411922453607

TABLA DE CORTE PARA PAN

bread cutting board
planche à découper le pain
brotschneidebrett
tábua para cortar pão

BAMBOO



ref.	Cms	H.	📦	Bar Code
747340	38x25	2	6/12	8411922448481

CUCHARA ESPAÑOLA

spanish spoon
cuillère espagnol
cucchiaio spagnolo
colher espanhol



ref.	cms.		Bar Code
747422	22	12/144	8411922437515
747425	25	12/144	8411922437522
747430	30	12/144	8411922437539

CUCHARA REDONDA

round spoon
cuillère rond
cucchiaio rotondo
colher redonda



ref.	cms.		Bar Code
747625	25	6/96	8411922437560
747630	30	6/96	8411922437577

TENEDOR

fork
fourchette
garfo



ref.	cms.		Bar Code
747515	15	12/144	8411922437546
747522	22	12/144	8411922437553
747530	30	6/96	8411922438598

Mini

TIJERA - PINZA

tong
pince
pinza
pinça



ref.	Cms		Bar Code
742300	28	6/96	8411922439915

SERVIDOR DE MIEL

honey spoon
cuillère à miel
cucchiaio per miele
colher de mel



ref.	cms.		Bar Code
747918	18	12/144	8411922437607

ESPÁTULA

spatula
spatule
spatola
espátula



ref.	cms.		Bar Code
747730	30	6/96	8411922437584

ESPÁTULA PERFORADA

perforated spatula
spatule perforée
spatola perforata
espátula perforada



ref.	cms.		Bar Code
747830	30	6/96	8411922437591

ESPUMADERA

skimmer
escumoire
schiumarola
escumadera de fritos



ref.	Cms		Bar Code
746630	30	12/96	8411922439236

PALA PARA PESCADO

fish server
pelle à poisson
fischschaufel
pá para peixe

ibili design



ref.	cms.		Bar Code
683100	30x12	6/36	8411922456943

ESPATULA PARA WOK

wok spatula
spatule pour wok
wok-kelle
espátula para wok

ibili design



ref.	cms.		Bar Code
751430	30X6	6/96	8411922445039

ESPATULA INCLINADA

angled spatula
spatule incline
angewinkelte kelle
espátula inclinada

ibili design



ref.	cms.		Bar Code
751530	30X6	6/96	8411922445046

PALA-ESPÁTULA XL

spatula XL
spatule XL
spatel XL
espátula XL



ref.	cms.	H.		Bar Code
747734	34	8,6	6/72	8411922449921

CUCHARA PARA CONFITURAS

marmalade spoon
cuillère à confiture
marmeladelöffel
colher para compotas

ibili design



ref.	cms.		Bar Code
755918	18	6/72	8411922453942

SERVIDOR PASTA DE MADERA

spaguetti server
cuillère spaghetti
pasta löffel
colher para spaguate

NEW



ref.	cms.		Bar Code
686900	30,5	6/36	8411922459494

MAZO TENDERIZADOR

meat tenderiser
attendrisseur à viande
fleischhammer
maço amaciador

MADERA DE HAYA

ALUMINIUM

NEW



ref.	cms.		Bar Code
686800	32	6/24	8411922459487

RODILLO GRANDE

Rolling pin
Rouleau à pâtisserie
Nudelholz
Rolo de massa

Asas giratorias
Rotary handles



ref.	Cms.	Ø	📦	Bar Code
747930	43	6,5	6/12	8411922453515

RODILLO PEQUEÑO

Rolling pin
Rouleau à pâtisserie
Nudelholz
Rolo de massa

Asas giratorias
Rotary handles



ref.	Cm.	Ø	📦	Bar Code
747920	43	4,4	6/24	8411922453508

TENEDOR MANGO REDONDO

fork with round handle
fourchette avec manche rond
gabel mit rundem griff
garfo com mango redondo

ECO

MANGO REDONDO
ROUND HANDLE



ref.	cms.	📦	Bar Code
747522R	22	6/72	8411922453553
747530R	30	6/36	8411922453560

CUCHARA REDONDA CON MANGO REDONDO

round spoon with round handle
cuillère ronde avec manche rond
runder löffel mit rundem griff
colher redonda com mango redondo

ECO

MANGO REDONDO
ROUND HANDLE



ref.	cms.	📦	Bar Code
747625R	25	6/72	8411922453539
747630R	30	6/36	8411922453546
747635R	35	6/36	8411922453737
747640R	40	6/36	8411922453744

ESPATULA PERFORADA CON MANGO REDONDO

perforated spatula with round handle
spatule perforée avec manche rond
kelle gelocht mit rundem griff
espátula perforada com mango redondo

ECO

MANGO REDONDO
ROUND HANDLE



ref.	Cms.	📦	Bar Code
747830R	30	6/36	8411922453577

CUCHARA/ESPÁTULA PARA SANGRÍA

sangría ladle
cuillère/spatule pour sangria
sangrialöffel/-spatel
colher/espátula para sangria



ref.	Cms	📦	Bar Code
755833	33,50	6/96	8411922448528

ESPÁTULA PARA CREPES

Spatula crêpes
Spatule crêpes
Kelle crêpes
Espátula crêpes

ECO



ref.	Cms	📦	Bar Code
716513	13	6/36	8411922455311
716518	18	6/36	8411922455328

ESPATULA PARA TORTILLAS

Spatula for omelettes
Spatule pour omelettes
Pfannenwender für Omeletts
Espátula para omeletas

loili design



Especial para tortillas
Special for omelettes

ref.	Cms.	📦	Bar Code
685400	28,5	6/36	8411922458459

PALILLOS
 chopsticks
 baguettes
 essstäbchen
 panzinhos



8 ud. MADERA DE HAYA BEECH WOOD



ref.	cms.		Bar Code
683500	24	6/72	8411922457025

PINCHOS DE BAMBÚ

tapas prikker
 piques en bambou
 bambusspieße
 palitos de bambu

50 ud.



ref.	cms.		Bar Code
752209	9	6/144	8411922441789

PINCHOS DE BAMBÚ

tapas prikker
 piques en bambou
 bambusspieße
 palitos de bambu

70 ud.

50 ud.

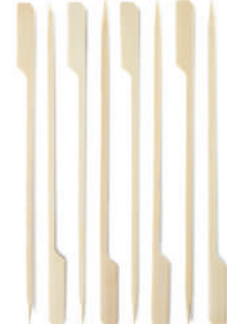

	ref.	cms.		Bar Code
A	752109	9	6/144	8411922441765
B	752118	18	6/144	8411922441772

BROCHETAS DE BAMBÚ

bamboo skewers
 brochettes bamboo
 espetos de bambú

100 ud.

50 ud.



ref.	cms.		Bar Code
753620	20	12/288	8411922084917
753630	30	12/288	8411922084924

JAMONERO KOMPAKTO

Kompakto ham stand
Serre-jambon kompakto
Kompakto schinkenhalter
Suporte para presunto kompakto

AJUSTABLE A TODOS LOS TAMAÑOS DE JAMÓN
AJUSTABLE TO ALL SIZES OF HAMS

INOX / S. STEEL
MADERA DE CAUCHO
RUBBER WOOD

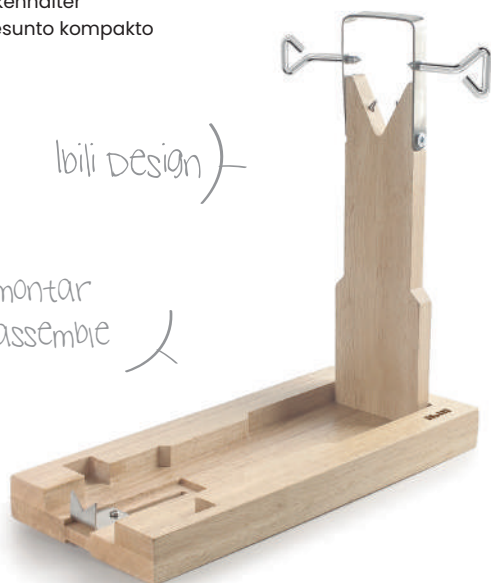

loli design

fácil de montar
easy to assemble



fácil de guardar
easy to store



ref.	Cms.	📦	Bar Code
684200	17x40	1/6	8411922457407

PINZA MAGNÉTICA MULTIUSOS

multipurpose magnetic tongs
pinces magnétiques multi-usages
mehrzweck-zange mit magnet
pinça magnética multiuso



loli design

BAMBOO

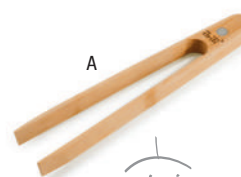

ímán magnet

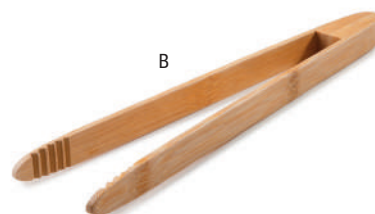

ref.	cms.	📦	Bar Code
709422	22	20	8411922448085
709400	28	6/96	8411922441413

A
B

PINZA MULTIUSOS

Multipurpose tongs
Pinces multi-usages
Mehrzweck-zange
Pinça multiuso

ref.	Cms.	📦	Bar Code
716730	30	6/36	8411922455335
716732	32	6/36	8411922455342
716740	40	6/36	8411922455359



ECO

MADERA DE HAYA
BEECH WOOD



INTENSE

ESPUMADERA

skimmer
escumoire
schaumlöffel
escumadeira de fritos

ibili design



ref.	cms.	∅		Bar Code
762010	36	10	6/36	8411922447613

ESPUMADERA DE MALLA

skimmer mesh
ecumoire maille
sieblöffel
escumadeira malha



ref.	cms.	∅		Bar Code
762011	36	11	6/36	8411922447620

ESPUMADERA DE ALAMBRE

wire skimmer
ecumoire à fil
drahtlöffel
escumadeira arame



ref.	cms.	∅		Bar Code
762025	36	12	6/36	8411922447767

CACILLO

soup ladle
louche
suppenlöffel
concha

ibili design



ref.	cms.	∅		Bar Code
762012	33	8	6/36	8411922447637

ESPATULA

spatule
spatule
kelle
espátula



ref.	cms.		Bar Code
762013	35	6/36	8411922447644

CUCHARA

spoon
cuillère
löffel
colher



ref.	cms.		Bar Code
762015	33	6/36	8411922447668

ESPÁTULA PALETA RECTA

straight spatula
spatule droite
grader spatel
espátula reta

NEW

ref.	cms	H		Bar Code
762052	26,5	7,5	6/72	8411922459760



ESPÁTULA A PALA DE SILICONA

silicone spatula
spatule en silicone
silikonspatel
espátula silicona

SILICONE

INOX /
S. STEEL

NEW

ref.	cms	H		Bar Code
762051	30,5	7,7	6/72	8411922459562



CUCHARA PASTA

spaguetti server
cuillère spaghetti
pastalöffel
colher para spaguete

ref.	cms.		Bar Code
762016	32	6/36	8411922447675



TENEDOR

fork
fourchette
gabel
garfo

ref.	cms.		Bar Code
762014	34	6/36	8411922447651



BATIDOR

whisk
fouet
mixer
batedor

ref.	cms.		Bar Code
762017	31	6/24	8411922447782



PALA PARA PESCADO

fish server
pelle à poisson
fischschaufel
pá para peixe

ref.	cms.		Bar Code
762019	32	6/24	8411922447705



RALLADOR

grater
râpe
reibe
raspador

ref.	cms.		Bar Code
762026	27	6/48	8411922447774



PALA DE SERVIR TARTAS

cake server
pelle à tarte
kuchenheber
pá para servir bolo

ref.	cms.		Bar Code
762037	26	6/48	8411922447880



CUCHILLO PARA QUESO

Cheese knife
Couteau à fromage
Käsemesser
Faca para queijo

ref.	cms.		Bar Code
762049	26	6/72	8411922458336



CUCHARA NYLON

spoon nylon
cuillère nylon
löffel nylon
colher nylon

INOX /
S. STEEL

NYLON



ref.	cms.		Bar Code
762022	33	6/36	8411922447736

ESPATULA NYLON

spatule nylon
spatule nylon
kelle nylon
espátula nylon

INOX /
S. STEEL

NYLON



ref.	cms.		Bar Code
762020	36	6/36	8411922447712

CACILLO NYLON

soup ladle nylon
louche nylon
suppenlöffel nylon
concha nylon

INOX /
S. STEEL

NYLON



ref.	cms.		Bar Code
762021	32	6/36	8411922447729

ESPUMADERA NYLON

skimmer nylon
escumoire nylon
schaumlöffe
escumadeira de fritos nylon

INOX /
S. STEEL

NYLON



ref.	cms.	Ø		Bar Code
762023	34	11	6/24	8411922447743

CUCHARA PASTA NYLON

spaguetti server nylon
cuillère spaghetti nylon
pastalöffel nylon
colher para spaguete nylon

INOX /
S. STEEL

NYLON



ref.	cms.		Bar Code
762024	33	6/36	8411922447750

BATIDOR SILICONA

silicone whisk
fouet silicone
silicon mixer
batedor silicona

INOX /
S. STEEL

SILICONE



ref.	cms.		Bar Code
762018	28	6/24	8411922447699

PINCEL SILICONA

silicone brush
pinceau en silicone
silikonpinsel
espátula de silicona



INOX /
S. STEEL

SILICONE

ref.	cms.		Bar Code
762027	22	6/60	8411922447781

ABRELATAS

tin opener
ouvre - boîtes
dosenöffner
abre-latas



ref.	cms.		Bar Code
762030	21	6/54	8411922447811

PRENSA AJOS

garlic press
presse-ail
knoblauchpresse
estremedor de alhos



ref.	cms.		Bar Code
762031	20	6/54	8411922447828

CACILLO CON ESCURRIDOR

Ladle with strainer
Louche avec égouttoir
Schöpföffel mit abtropfsieb
Concha com escorredor



ibili design



ref.	Cms	Ø	📦	Bar Code
762048	31	8	6/36	8411922456240

MAZO TENDERIZADOR PARA CARNE

Meat tenderiser
Attendrisseur à viande
Fleischhammer
Maço amaciador para carne



INOX / S. STEEL

ref.	Cms	Ø	📦	Bar Code
762047	27	6	6/24	8411922456004

DESCAPSULADOR

bottle opener
décapsuleur
flaschenöffner
descapsulador



ref.	cms.	📦	Bar Code
762028	19	6/60	8411922447798

DESCORAZONADOR

apple corer
vide-pommer
entkerner
descaraçador



ref.	cms.	📦	Bar Code
762029	20	6/54	8411922447804

RULETA CORTA PASTAS

cookie cutter
emporte-pièces
cookieschneider
corta-massas



ref.	cms.	📦	Bar Code
762034	18	6/54	8411922447859

ABREBOTES

can opener
ouvre-bocaux
deckelöffner
abre-boiões



ref.	cms.	📦	Bar Code
762032	26	6/36	8411922447835

CORTAPIZZA

pizza cutter
roulette à pizza
pizzaschneider
corta-pizzas



ref.	Ø	📦	Bar Code
762036	20	6/48	8411922447873

ABREOSTRAS

oyster opener
couteau à huîtres
austernöffner
abre-ostras



ref.	Ø	📦	Bar Code
762038	17	6/48	8411922447897

RACIONADOR DE HELADO

ice cream scoop
cullère à glaces
eislöffel
colher de gelado



ref.	cms.	📦	Bar Code
762035	20	6/54	8411922447866

CUCHILLO-ESPÁTULA PARA MANTEQUILLA

Butter knife spreader
Butterstreichmesser
Couteau-spatule pour le beurre
Faca - espátula para manteiga

INOX / S. STEEL



ref.	cms.	📦	Bar Code
762050	19	6/72	8411922458343

CORTADOR DE QUESO

cheese slicer
coupe-fromages
käseschneider
paca para queijos



ref.	cms.		Bar Code
762045	25	6/48	8411922448061

DESCORAZONADOR DE TOMATE

tomatoe corer
vide-tomate
tomatenentkerner
descaroçador para tomate



ref.	cms.		Bar Code
762046	17	6/72	8411922448078

RALLADOR DE LIMON

lemon grater
râpe a citron
zitronenreibe
raspador de limao



ref.	cms.		Bar Code
762044	16	6/72	8411922448054

MECHADOR

larding needle
aiguille à larder
spicknadel
agulha p/rechear



ref.	cms.		Bar Code
762043	42	6/36	8411922448047

VACIADOR

fruit baller
moule à boules
ausstecher
cortador



ref.	cms.		Bar Code
762039	17	6/72	8411922448009

PRENSA PATATAS

potatoe masher
presse purée
kartoffelpresse
amasador de batata



ref.	Ø		Bar Code
762041	28	6/36	8411922448023

PELATOMATES

tomatoe peeler
éplucheur à tomate
tomatenschäler
descascador de tomate



ref.	cms.		Bar Code
762042	20	6/48	8411922448030

PELATPATATAS

potatoe peeler
éolucheur à legumes
kartoffelschäler
descascador de batatas



ref.	cms.		Bar Code
762033	19	6/72	8411922447842

PELATPATATAS "Y"

"y" potatoe peeler
éplucheur à legumes "y"
kartoffelschäler „y“
descascador de batatas "y"



ref.	cms.		Bar Code
762040	17	6/72	8411922448016

ESPATULA PARA TORTILLAS

Spatula for omelettes
Spatule pour omelettes
Pfannenwender für Omeletts
Espátula para omeletas

-Perfecta ergonomía para manipulación de tortilla.
-Ergonomic shape for precise omelette manipulation.

NYLON ~~BPA~~

ERGONOMIC



ref.	Cms		Bar Code
682800	28x6	6/72	8411922456257

ESPÁTULA PARA CREPES

spatula crêpes
spatule crêpes
kelle crêpes
espátula crêpes

NYLON ~~BPA~~

ibili design



ref.	Cms		Bar Code
738760	32	6	8411922454376

PALA PARA COOKIES / PATATAS FRITAS

spatula for chips/cookies
pelle pour cookies / frites
für kekse/pommes frites
pá para cookies / batatas fritas

NYLON ~~BPA~~

con colgador
with hanger



ref.	Cms		Bar Code
780510	33x17,5	6/48	8411922449211

Soft

NYLON ~~BPA~~

CUCHARA

spoon
cuillère
löftel
colher

ref.	Cms.		Bar Code
734051	30,5	12/72	8411922450088

CACILLO

soup ladle
louche
suppenlöftel
concha

ref.	Cms.		Bar Code
734050	31	12/72	8411922450071



ESPÁTULA

spatule
spatule
kelle
espátula

ref.	Cms.		Bar Code
734052	31,5	12/72	8411922450095

CUCHARA PASTA

spaguetti server
cuillère spaguetti
pasta löftel
colher para spaguete

ref.	Cms.		Bar Code
734053	30	12/72	8411922451009

ESPUMADERA

skimmer
ecumoire
schumlöftel
escumadera de fritos

ref.	Cms.		Bar Code
734054	31	12/72	8411922451016

Nylon +

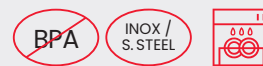

ESPUMADERA

skimmer
ecumoire
escumadeira de fritos



ref.	cms.		Bar Code
772700	34	12/144	8411922077735

ESPATULA

turner
spatule
espátula



ref.	cms.		Bar Code
772800	33	12/144	8411922077742

CACILLO

ladle
louche
concha



ref.	cms.		Bar Code
772900	30	12/144	8411922077759

CUCHARA

spoon
cuillère
colher



ref.	cms.		Bar Code
773000	33	12/144	8411922077766

CUCHARA PASTA

spaguetti server
cullère à spaguetti
colher para esparguette



ref.	cms.		Bar Code
773050	31	12/144	8411922079135



Nylon



Nylon Para superficies antiadherentes · For non-stick surfaces · Pour des surfaces anti-adhérentes · Per superfici antiaderenti · Para superficies antiaderentes

PALA PARA LASAÑA/PLANCHA

lasagna and grill spatula
pelle à lasagne/plancha
spachtel für lasagne/grill
espátula para lasanha/grelhados



ref.	cms.		Bar Code
738750	30	6/72	8411922451511

ESPÁTULA PLANCHA

spatula grill
spatule plancha
spatola piastra
espátula chapas



ref.	cms.		Bar Code
738700	32x10	6/36	8411922093261

CACILLO PARA ACEITUNAS

olive spoon
louche à olives
olivenlöffel
colher para azeitonas

loli design



Tamaño pequeño
Small size



BPA

NYLON

ref.	cms.	Ø	📦	Bar Code
719106	24	6,5	6/72	8411922449419
719110	28	8	6/36	8411922448160

Emma

INOX /
S. STEEL

CUCHARA

spoon
cuillère
cucchiaio
colher



ref.	Cms.	H.	📦	Bar Code
733903	32	7	12	8411922087161

ESPUMADERA

skimmer
escumaire
schiumarola
escumadeira de fritos



ref.	Cms.	H.	📦	Bar Code
733900	33	1,0	12	8411922087130

CACILLO

soup ladle
louche
mestolo
concha



ref.	Cms.	H.	📦	Bar Code
733901	30	8,5	12	8411922087147

ESPÁTULA

turner
spatule
spatola
espátula



ref.	Cms.	H.	📦	Bar Code
733902	32	8	12	8411922087154

ESPUMADERA

skimmer
ecumoire
escumadeira de fritos



ref.	cms.	H.		Bar Code
710300	11	35	12/72	8411922622140

CACILLO

soup ladle
louche
concha



ref.	cms.	H.		Bar Code
710400	9	30	12/72	8411922622157

CACILLO SALSA

sauce ladle
cuillère à sauces
colher para molhos



ref.		Bar Code
710401	12/72	841192208030

ESPÁTULA

turner
spatule
espátula



ref.	H.		Bar Code
710500	33	12/72	8411922622164

CUCHARA

spoon
cuillère
colher



ref.	H.		Bar Code
710600	34	12/72	8411922622171

TENEDOR

fork
fourchette
garfo



ref.		Bar Code
710700	12/72	8411922622188

CUCHARA CON AGUJEROS

slotted spoon
cuillère perforée
colher perfurada



ref.	cms.		Bar Code
710800	34	12/72	8411922622195

CUCHARA PASTA

spaghetti server
cuillère à spaghetti
colher para espaguete



ref.		Bar Code
710900	12/72	8411922622201

Supra

ACERO INOXIDABLE PULIDO
STAINLESS STEEL POLISHED
INOX POLI
INOX PULIDO



CACILLO

soup ladle
louche
concha



ref.	H.		Bar Code
712900	30	12/72	8411922423518

ESPUMADERA

skimmer
ecumoire
escumadeira de fritos



ref.	cms.	H.		Bar Code
712800	11	33	12/72	8411922423501

ESPÁTULA

turner
spatule
espátula



ref.	H.		Bar Code
713000	33	12/72	8411922423525

CUCHARA

spoon
cuillère
colher



ref.	H.		Bar Code
713100	34	12/72	8411922423532

TENEDOR

fork
fourchette
garfo



ref.	H.		Bar Code
713200	35	12/72	8411922423549

JUEGO 5 PIEZAS CON SOPORTE (caja ind.)

5 pieces set with revolving rack (Ind. box)
5 ustensiles, support pied (Boîte ind.)
jogo de 5 peças com suporte (Caixa ind.)



ref.	H.		Bar Code
759702	41,5	1/1	8411922204155

SOPORTE ALAMBRE UTENSILIOS

tools stand
support pied pour ustensiles
suporte de arame p/utensilios



ref.	H.		Bar Code
759701	41,5	1/12	8411922204391

COLGADOR DE BARRA

wall rack
penderie murale
suporte parede



ref.	cms.			Bar Code
764540	40	6/48	8	8411922208986
764550	50	6/36	10	8411922203844

Prisma

ACERO INOXIDABLE
STAINLESS STEEL
INOX
INOX



ESPUMADERA DE MALLA

skimmer mesh
ecumoire maille
escumadeira malha

INOX /
S. STEEL
18/10

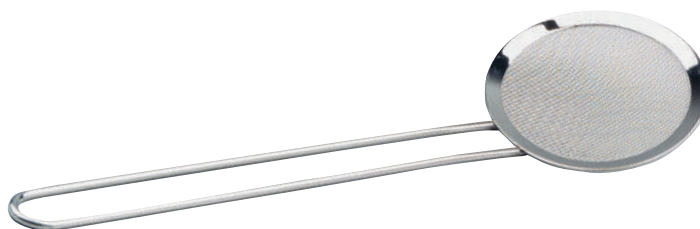

ref.	cms.	H.		Bar Code
764410	10	34	6/72	8411922203820
764412	12	39	6/72	8411922205640

CACILLO MINI

mini ladle
louche mini
mestolo mini
concha mini

INOX /
S. STEEL



ref.	Ø	H.		Bar Code
733804	4	14	6/240	8411922087116
733806	6	22	6/144	8411922087123

Supreme

NYLON. MANGO INOX 18/10. IDEAL PARA ANTIADHERENTES
NYLON. SPECIAL FOR NON-STICK
NYLON. ESPECIAL POUR ANTIADHÉRENT
NYLON. ESPECIAL PARA ANTIADHERENTES



ESPUMADERA

skimmer
ecumoire
escumadeira de fritos



ref.	cms.	H.		Bar Code
759000	11	35	12/144	8411922621761

CACILLO

soup ladle
louche
concha



ref.	cms.	H.	Its.		Bar Code
759100	9	32	0,1	12/144	8411922621778

CUCHARA

spoon
cuillère
colher



ref.	H.		Bar Code
759200	31	12/144	8411922621785

ESPÁTULA LARGA

turner
spatule
espátula



ref.	H.		Bar Code
759300	32	12/144	8411922621792

2000

NYLON. IDEAL PARA ANTIADHERENTES
 NYLON. SPECIAL FOR NON-STICK
 NYLON. ESPECIAL POUR ANTIADHÉRENT
 NYLON. ESPECIAL PARA ANTIADHERENTES

NYLON ~~BPA~~

max. 220°C

ESPUMADERA
 skimmer
 ecumoire
 escumadeira de fritos



ref.	cms.	H.	📦	Bar Code
757300	11	31	12/144	8411922600339

CACILLO
 soup ladle
 louche
 concha



ref.	cms.	H.	lbs.	📦	Bar Code
757600	9	31	0,1	12/144	8411922600308

CUCHARA
 spoon
 cuillère
 colher



ref.	H.	📦	Bar Code
757700	31	12/144	8411922600315

ESPÁTULA
 turner
 spatule
 espátula



ref.	H.	📦	Bar Code
757800	33	12/144	8411922600322

Colorful

COLORFUL

SET 6 UTENSILIOS + SOPORTE

set 6 utensils + support
 set 6 utensiles + support
 set 6 utensili + support
 set 6 utensilios + suporte



NYLON ~~BPA~~

Evita el contacto del alimento con las diferentes superficies de la cocina mejorando en limpieza e higiene

Prevents food from coming into contact with the various kitchen surfaces, improving cleanliness and hygiene



ref.	📦	Bar Code
740500	1/4/8	8411922434835

Kristall

GLASS

BOTELLA

bottle
bouteille
bottiglia
garrafa

1000 ml

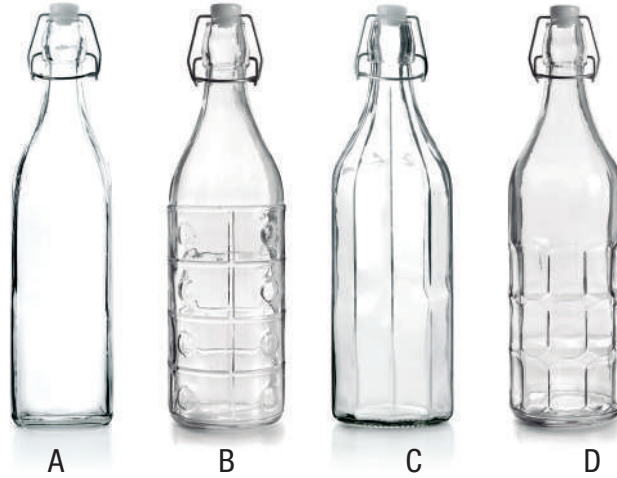

A

B

C

D

Surtido / Assorted 2A + 2B + 1C + 1D = 6

ref.	Lts.	H.		Bar Code
740101	1,0	32	6/6	8411922434682

BOTELLA

bottle
bouteille
bottiglia
garrafa

500 ml



A

B

Surtido / Assorted 3A + 3B = 6

ref.	Lts.		Bar Code
740202	0,250	6/24	8411922435610
740205	0,500	6/6	8411922434699

BOTELLA LECHE

milk bottle
bouteille de lait
bottiglia per il latte
garrafa de leite

1000 ml



ref.	Lts.	H.		Bar Code
740310	1,0	29	6/6	8411922434705

BOTELLA DECORADA

decorated bottle
bouteille décorée
bottiglia decorata
garrafa decorada

1000 ml



A

B

Surtido / Assorted 3A + 3B = 6

ref.	Lts.		Bar Code
740111	1,0	6/24	8411922435627

BOTELLA RETRO

bottle retro
bouteilleretro
flasche retro
garrafa retro

NEW



ref.	Ø	H	Lts.	📦	Bar Code
713810	8	31,5	1,000	6/18	8411922459586

BOTELLA LAZO

bottle lazo
bouteille lazo
flasche lazo
garrafa lazo

TAPÓN inox
s. steel cap



ref.	Lts.	📦	Bar Code
713405	0,500	6/24	8411922451962
713410	1,000	6/18	8411922451948

BOTELLA LINE

bottle line
bouteille line
flasche line
garrafa line



ref.	Lts.	📦	Bar Code
713610	1,000	6/18	8411922451955

BOTELLA SQUARE

bottle square
bouteille square
flasche square
garrafa square



ref.	Lts.	📦	Bar Code
713705	0,500	6/36	8411922451993
713710	1,000	6/18	8411922451986

JARRA

Pitcher
Pichet
Krug
Jarra

Tapa plástica
Plastic lid



ref.	cms.	Lts.	H	📦	Bar Code
743850	8x8	1,1	23,5	6	8411922457940
743875	11x8,5	1,8	26	6	8411922470345

NEW

TARRO MINI

jar mini
pot mini
vasetto mini
tarro mini

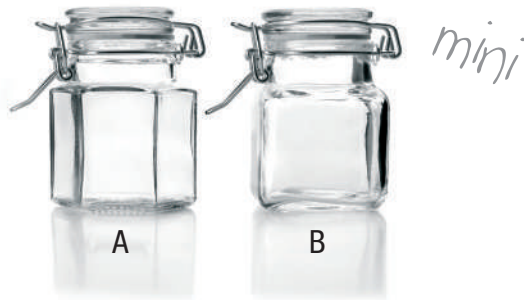

Hexagono+cuadrado
Hexagon+square
Hexagone+carré
Esagono+quadrato
Hexagono+quadrado

Surtido / Assorted 6A + 6B = 12

ref.	Lts.		Bar Code
739901	0,100	12/12	8411922434668

TARRO MINI

jar mini
pot mini
vasetto mini
tarro mini



Redondo
Round
Rond
Fondo
Redondo

Surtido / Assorted 6A + 6B = 12

ref.	Lts.		Bar Code
740000	0,045+0,065	12/12	8411922434675

TARRO COCINA

jar
pot
vaso
tarro



ref.	Lts.		Bar Code
742905	0,540	6/24	8411922435634
742908	0,800	6/12	8411922435641
742915	1,500	6/12	8411922435658

TARRO

Jar
Pot
Einmachglas
Frasco



ref.	Ø	Lts.	H.		Bar Code
747210	10,8	0,53	19,5	6	8411922457919
747220	10,8	0,64	23	6	8411922457926
747230	10,8	0,82	23,5	6	8411922457933

Barware

BARWARE

SACACORCHOS DE PALANCA VERTICAL CLASS

vertical lever corkscrew class
tire-bouchon vertical à levier class
senkrechter hebelkorkenzieher class
saca-rolhas vertical de alavanca class



INOX / S. STEEL

PLASTIC

ref.	Cms		Bar Code
695001	16	1/6/12	8411922446166

SACACORCHOS PALANCA VERTICAL LUXE

vertical lever corkscrew luxe
tire-bouchon à levier vertical luxe
senkrechter hebelkorkenzieher luxe
saca-rolhas vertical de alavanca luxe



INOX / S. STEEL

PLASTIC

ref.	Cms		Bar Code
695003	16	1/6/12	8411922446180

SACACORCHOS DE PALANCA HORIZONTAL

lever corkscrew – horizontal
tire-bouchon à levier horizontal
korkenzieher mit horizontalem hebel
saca-rolhas de alavanca horizontal



INOX / S. STEEL

PLASTIC

ref.	Cms		Bar Code
695004	18	1/6/12	8411922446197

SACACORCHOS BODEGA

selfpull wine opener
tire-bouchon cave à vins
korkenzieher weinkeller
saca-rolhas bodega



espiral fresada
milled spiral

ACERO CROMADO

ref.	Cms		Bar Code
695040	15	6/48	8411922446784

DESCORCHADOR GIRATORIO CON ALAS

self pulling corkscrew
tire-bouchon à levier
drehkorkenzieher mit flügeln
saca-rolhas giratório com pegas

tacto suave
soft touch



INOX / S. STEEL

PLASTIC

ref.	Cms		Bar Code
695000	16	6/48	8411922446159



SACACORCHOS DOBLE PALANCA METÁLICO

winged corkscrew
tire-bouchon double levier métallique
korkenzieher mit metallischem doppelhebel
saca-rolhas metálico de dupla alavanca



INOX / S. STEEL

ref.	Cms		Bar Code
695005	18	6/48	8411922446203



SACACORCHOS GIRATORIO CONFORT

Corkscrew confort
Tire-bouchon confort
Korkenzieher confort
Saca-rolhas confort

INOX /
S. STEEL

PLASTIC



incluye cortacápsulas
foil-cutter included



ref.	Cms	📦	Bar Code
695043	17,5	6	8411922457384

SACACORCHOS ELECTRICO

Electric wine opener
Ouvre-bouteille électrique
Elektrischer korkenzieher
Abridor de vinho eléctrico

PLASTIC

METALLIC



(soft touch

con cortador
de láminas
with foil cutter

🔋
4x AA
NO INCLUIDAS
NOT INCLUDED

ref.	H	📦	Bar Code
695045	24	6/24	8411922457841

SACACORCHOS DOBLE PALANCA ECO

winged corkscrew eco
tire-bouchon double levier eco
korkenzieher mit doppelhebel eco
saca-rolhas de dupla alavanca eco

ACERO
CROMADO

PLASTIC



ref.	Cms	📦	Bar Code
695006	17	6/48	8411922446210

SACACORCHOS DOBLE PALANCA CLASS

winged corkscrew
tire-bouchon double levier métallique
korkenzieher mit metallischem doppelhebel
saca-rolhas metálico de dupla alavanca

INOX /
S. STEEL

PLASTIC



tacto suave
soft touch



ref.	Cms	📦	Bar Code
695007	17	6/48	8411922446227

SACACORCHOS GIRATORIO CERRADO

selfpull wine opener
tire-bouchon rotatif fermé
geschlossener drehkorkenzieher
saca-rolhas giratório fechado

INOX /
S. STEEL

PLASTIC



ref.	Cms	📦	Bar Code
695008	12,5	6/48	8411922446234

SACACORCHOS DOBLE PALANCA LOVE

Winged corkscrew Love
Tire-bouchon double levier Love
Korkenzieher mit Doppelhebel Love
Saca-rolhas de dupla alavanca Love

ACERO
CROMADO

PLASTIC



ref.	H	📦	Bar Code
695044	17	6/48	8411922457834

ABRIDOR DE CHAMPAGNE

champagne bottle opener
tire-bouchon à champagne
champagneröffner
abridor de champanha



ACERO CROMADO PLASTIC

ref.	Cms		Bar Code
695010	17,5	6/48	8411922446258

SACACORCHOS DOBLE APOYO + DESCAPSULADOR

double hinged corkscrew
+ bottle opener
tire-bouchon double appui
+ décapsuleur
korkenzieher mit doppelauflage
+ folienschneider
aca-rolhas de duplo apoio
+ corta cápsulas



INOX / S.STEEL PLASTIC

ref.	Cms		Bar Code
695015	14,7	6/72	8411922446302

SACACORCHOS 2 TIEMPOS CLASS

2 step class corkscrew
tire-bouchon 2 temps class
2-fach-korkenzieher class
saca-rolhas de 2 movimentos class



INOX / S.STEEL PLASTIC

ref.	Cms		Bar Code
695016	11,5	6/72	8411922446319

SACACORCHOS CAMARERO LUXE

luxe waiter's wine key
tire-bouchon serveur luxe
korkenzieher kellner luxe
saca-rolhas de mordomo de luxe



INOX / S.STEEL PLASTIC

ref.	Cms		Bar Code
695017	12	6/72	8411922446326

SACACORCHOS + ABRECHAPAS

corkscrew + bottle opener
tire-bouchon + décapsuleur
saca-rolhas + descapsulador



ref.		Bar Code
784700	12/144	8411922085136

SACACORCHOS DOBLE APOYO

corkscrew double level
tire-bouchon double levier
cavatappi doppia leva
saca-rolhas dos tempos



INOX / S.STEEL

ref.	cms.		Bar Code
709100	12	6/144	8411922076905

SACACORCHOS MAYORDOMO

cork puller
tire-bouchon majordome
korkenzieher kellner
saca-rolhas mordomo



ACERO CROMADO PLASTIC

ref.	Cms		Bar Code
695009	11	6/72	8411922446241

DESCAPSULADOR METAL LUXE

circle foil cutter luxe
coupe-capsule métal luxe
folienschneider aus metall luxe
corta cápsulas de metal de luxe

METALLIC INOX / S. STEEL



ref.	Ø	📦	Bar Code
695018	6	6/72	8411922446333

DESCAPSULADOR ECO

foil cutter eco
coupe-capsule eco
folienschneider eco
corta cápsulas de rolha eco

PLASTIC



ref.	Cms	📦	Bar Code
695019	7	6/72	8411922446340

BOMBA DE VACIO INOX + 2 TAPONES

vacuum pump saver with 2 stoppers
pompe à vide inox + 2 bouchons
vakuumpumpe aus edelstahl + 2 deckel
bomba de vácuo inox + 2 tampões

INOX / S. STEEL SILICONE



ref.	Cms	📦	Bar Code
695032	15	6/48	8411922446470

TAPONES DE REPUESTO PARA BOMBA DE VACÍO

replacement stoppers for vacuum pump
bouchons de rechange pour pompe à vide
ersatzverschlüsse für vakuumpumpe
tampões de reposição para bomba de vácuo

SILICONE

2 ud.



ref.	Cms	📦	Bar Code
695039	15	12/72	8411922446548

TAPÓN DE VINO CON BOMBA DE VACIO

vacuum stopper
bouchon de vin avec pompe à vide
weinverschluss mit vakuumpumpe
tampão de vinho com bomba de vácuo

METALLIC



ref.	Cms	📦	Bar Code
695033	8	6	8411922446487

TAPÓN DE VACÍO ECO

vacuum wine saver eco
bouchon-pompe à vide pour le vin eco
tappo sottovuoto per vino eco
tampão de vácuo para vino eco

PLASTIC



ref.	H	📦	Bar Code
695041	5,8	6/120	8411922451528

BOMBA VACIO

vacuum wine saver
pompe à vide
bomba de vácuo



ref.	cms.	📦	Bar Code
781100	14	1/6	8411922082456

TAPÓN DE VACÍO PARA VINO

vacuum wine saver
bouchon-pompe à vide pour le vin
tappo sottovuoto per vino
tampão de vácuo para vino

PLASTIC



ref.	H	📦	Bar Code
788800	8,5	6/36	8411922089639

TAPÓN PARA CHAMPAGNE-VINO AJUSTABLE

champagne and wine sealer
 bouchon scelleur pour bouteille de champagne et de vin
 champagner- und weinverschluss
 tampão hermético para champanhe e vinho

PLASTIC



ref.	Cms	📦	Bar Code
695002	6	6/72	8411922446173

TAPÓN PARA CHAMPAGNE CON PULSADOR

champagne stopper with button
 bouchon pour champagne avec bouton-poussoir
 champagnerdeckel mit druckknopf
 tampão para champanhe com pulsador

INOX / S.STEEL SILICONE



ref.	Cms	📦	Bar Code
695011	5	6/72	8411922446265

TAPON PARA CHAMPAGNE ECO

champagne stopper eco
 tire-bouchon double levier eco
 champagnerdeckel eco
 tampão para champanhe eco

SILICONE PLASTIC



ref.	Cms	📦	Bar Code
695012	4,5	6/72	8411922446272

TAPON DE VINO SILVER

silver wine stopper
 bouchon de vin silver
 weinverschluss silver
 tampão para vinho silver

METALLIC SILICONE



ref.	Cms	📦	Bar Code
695026	7	6/72	8411922446418

TAPON PARA CAVA

champagne cap
 bouchon de champagne
 rolha champanhe

METALLIC



ref.	📦	Bar Code
722500	6/144	8411922080155

SET 2 TAPONES CÓNICOS PARA VINO

set 2 conic wine stoppers
 set 2 bouchons coniques pour vin
 set aus 2 konischen weindeckeln
 conjunto de 2 tampões cónicos para vinho

METALLIC SILICONE



ref.	Cms	📦	Bar Code
695028	6	6/72	8411922446432

SET 2 TAPONES DE VINO LUXE

set of 2 luxe wine stoppers
 set 2 bouchons de vin luxe
 set aus 2 deckeln für weinflaschen luxe
 conjunto de 2 tampões para vinho de luxe

ACERO CROMADO PLASTIC



ref.	Cms	📦	Bar Code
695029	3	6/72	8411922446449

SET 2 TAPONES CON EMBOLO

set 2 wine cap stoppers
 set 2 bouchons à piston
 set aus 2 deckeln mit pfropfen
 conjunto de 2 tampões com êmbolo

INOX / S.STEEL SILICONE PLASTIC



ref.	Cms	📦	Bar Code
695036	10	6/72	8411922446517

ESCANCIADOR DE VINO CON TAPON

wine pourer saber with sealer
 décanteur de vin + bouchon
 weinausschankhilfe + deckel
 escanciador de vinho com tampa

INOX /
S.STEEL



ref.	Cms		Bar Code
695020	8	6/72	8411922446357

ESCANCIADOR DE VINO

wine pourer saber
 décanteur de vin
 weinausschankhilfe
 escanciador de vinho

INOX /
S.STEEL



ref.	Cms		Bar Code
695021	8	6/72	8411922446364

ESCANCIADOR DE VINO CON CIERRE

wine pourer stopper
 décanteur de vin avec fermeture
 weinausschankhilfe mit deckel
 escanciador de vinho com tampa

INOX /
S.STEEL

SILICONE



ref.	Cms		Bar Code
695022	10	6/72	8411922446371

SET 2 ESCANCIADOR DE VINO CON FILTRO

set 2 wine pourers with filter
 set 2 décanteur de vin avec filtre
 2er-set weinausschankhilfe mit filter
 conjunto de 2 escanciadores de vinho com filtro

PLASTIC



ref.	Cms		Bar Code
695023	8,5	6/72	8411922446388

ESCANCIADOR DE VINO LUXE

wine pourer luxe
 décanteur de vin luxe
 weinausschankhilfe luxe
 escanciador de vinho luxe

METALLIC

SILICONE



ref.	Cms		Bar Code
695024	7,5	6	8411922446395

SET BOMBA DE VACIO + VERTEDOR

set vacuum pump saver stopper + pourer
 set verseur + pompe à vide
 set dispenser + vakuumpumpe
 conjunto de bomba de vácuo + vertedor

SILICONE

PLASTIC



ref.	Cms		Bar Code
695025	10	6/72	8411922446401

AIREADOR DE VINO INSTANTÁNEO

wine aerator pourer saver
aérateur à vin instantané
sofort-weinbelüfter
arejador de vinho instantâneo

ACERO
CROMADO

PLASTIC



ref.	Cms	📦	Bar Code
695027	16,5	6/72	8411922446425

SET 2 ANILLAS ANTI GOTEO

set of 2 drip rings
set 2 anneaux anti-gouttes
set aus 2 anti-tropfringen
conjunto de 2 anilhas anti-gotejamento

INOX /
S. STEEL



ref.	∅	📦	Bar Code
695031	4	6/72	8411922446463

BOLAS LIMPIA DECANTADOR

decanter cleaning beads
billes nettoyantes pour décanteur
reinigungskugeln für dekanter
esferas para limpeza de decantador

INOX /
S. STEEL



ref.	∅	📦	Bar Code
695035	4	6	8411922446500

TERMÓMETRO PARA BOTELLAS

auto wine thermometer
thermomètre pour bouteilles
flaschenthermometer
termômetro para garrafas

INOX /
S. STEEL



ref.	Cms	📦	Bar Code
695034	6,5	6/72	8411922446494

SET 12 MARCADORES DE COPAS

set 12 glass markers
set 12 identificateurs de verres
12er-set glas-marker
set 12 identificadores de taças

SILICONE



ref.	Cms	📦	Bar Code
695030	14,5	6/72	8411922446456

SET SACACORCHOS + BOMBA DE VACIO + 2 TAPONES

corkscrew set + wine saver + 2 stoppers
 set tire-bouchon + pompe à vide + 2 bouchons
 set korkenzieher + vakuumpumpe + 2 deckel
 conjunto de saca-rolhas + bomba de vácuo + 2 tampões

INOX / S. STEEL SILICONE PLASTIC



ref.	Cms		Bar Code
695013	20x17	1/6/12	8411922446289

SET SACACORCHOS + DESCAPSULADOR + ESCANCIADOR

corkscrew set + bottle opener + pourer
 set tire-bouchon + coupe-capsule + décanteur
 korkenzieher-set + folienschneider + ausschankhilfe
 conjunto de saca-rolhas + corta cápsulas + escanciador

INOX / S. STEEL SILICONE PLASTIC



ref.	Cms		Bar Code
695014	16,5x14	1/6/12	8411922446296

ENFRIABOTELLAS

bottle cooler
 rafraîchisseur à bouteilles
 glacette per bottiglie
 arrefecedor de garrafas

INOX / S. STEEL



AIREADOR DE VINO CON FILTRO

wine areator with filter
 aérateur de vin avec filtre
 arejador de vinho com filtro

INOX / S. STEEL



ref.	cms.	H		Bar Code
786100	11,5	20	4/12	8411922086072

ref.		Bar Code
784900	6/172	8411922085150

ABRECHAPAS

cap remover
ouvre-bouteilles
flashchenöffner
tira-cápsulas

METALLIC

PLASTIC

soft touch
tacto suave



6 + 6 + 6 + 6 = 24



ref.	cms.		Bar Code
752600	13X4,5	24/120	8411922445022

ABRECHAPAS

barmate opener
décapsuleur
kronkorkenöffner
abridor de cápsulas

INOX /
S. STEEL



ref.	Cms		Bar Code
695037	18	6/72	8411922446524



ABRIDOR DE CHAPAS

bottle opener
décapsuleur
kronkorkenöffner
abridor de cápsulas

INOX /
S. STEEL

PLASTIC



ref.	Cms		Bar Code
695038	13	6/72	8411922446531



SET 2 TAPONES PARA VINO

2 stoppers
2 bouchons
2 tampas

TPR



ref.		Bar Code
785300	6/144	8411922085198



ESCANCIADOR

bottle pourer
bec verseur
escanciador

INOX /
S. STEEL
18/10



ref.		Bar Code
785100	6/144	8411922085174



24 ETIQUETAS PARA VINO + ROTULADOR

24 wine tags + marking pen
24 étiquettes pour vin + crayon marqueur
24 etiquetas para vinho + marcador



ref.		Bar Code
785400	6/144	8411922085204



Tapones



TAPÓN VERTEADOR, STANDARD

bottle pourer, universal
bouchon verseur, standard
rolha para verter, standard



ref.		Bar Code
blister 764001	10/90	8411922203271
764011	12/240	8411922203608

TAPÓN VERTEADOR, STANDARD, CROMADO

bottle pourer, universal, chromed
bouchon verseur, standard, chromé
rolha para verter, standard, cromado



ref.		Bar Code
blister 764000	10/90	8411922203257
764010	12/240	8411922203592

TAPÓN VERTEADOR, STANDARD CON TAPA PROTECTORA

bottle pourer, universal, with lid
bouchon verseur, standard, avec couvercle
rolha para verter, standard, com tampa



ref.		Bar Code
blister 764002	10/10	8411922203295
764012	12/240	8411922203615

TAPÓN VERTEADOR DOSIFICADOR

bottle pourer-dispenser
bouchon verseur-doseur
tappo dosatore
rolha para verter, dosador



ref.	cl.		Bar Code
764022	2	6/90	8411922449990
764024	4	6/90	8411922450002
764006	5	6/90	8411922205756

TAPON VERTEADOR "CLASICA" STANDARD C/TAPA PLASTICO

bottle pourer, universal, s.steel with plastic lid
bouchon verseur, standard, inox avec couvercle en plastic
rolha para verter, standard, inox com tampa plástico



ref.		Bar Code
blister 759801	10/90	8411922069129
759811	12/240	8411922069167

TAPON VERTEADOR "CLASICA" CONICA C/TAPA METALICA

conical bottle pourer, s.steel with metallic lid
bouchon verseur conique, inox avec couvercle métallique
rolha para verter cónica, inox com tampa metálica



ref.		Bar Code
759812	12/12	8411922069174

TAPON VERTEADOR "CLASICA" CONICA

conical bottle pourer, s.steel
bouchon verseur conique, inox
rolha para verter cónica, inox



ref.		Bar Code
blister 759803	10/90	8411922069143
759813	12/240	8411922069181

SET 2 TAPONES DE SIDRA

set 2 cider pourers
lot 2 bouchons verseurs à cidre
jogo 2 rolhas para sidra



ref.		Bar Code
759900	6/6	8411922072761

ENFRIADOR DE BOTELLAS BLACK

bottle cooler black
refraichisseur à bouteilles black
flaschenküler black
errefecedor de garrafas black

NYLON

GEL



ref.	Cms	H.		Bar Code
786050	15,5	23	6/24	8411922449914

ENFRIADOR PARA LATAS

Can cooler
Refroidisseur de canettes
Dosenkühler
Arrefecedor de latas

PLASTIC

GEL



ref.	Cms	H.		Bar Code
786075	26x11	6/48		8411922456264

BOLSA ENFRIABOTELLAS 4 LADOS

bottle cooler bag 4 sides
sac housse réfrigération
pour bouteilles 4 côtes
refrigeratore a 4 parete
saco de arrefecer garrafas
4 lados



ref.	cms.	H.		Bar Code
778450	25x10	12/48		8411922090352

BOLSA ENFRÍABOTELLAS LUXE 2 LADOS

bottle cooler bag 2 sides
sac housse de réfrigération pour bouteilles 2 côtes
saco de arrefecer garrafas 2 lados

PLASTIC

GEL

4 azul / blue / bleu / azul
4 burdeos / burdeos /
bordeaux / bordeaux
4 transparente / transparent
/ transparent / transparente

Contiene gel enfriador en
su interior
With cooler jelly inside
Contenant gel réfrigérant
Contém gel enfriador no
interior



ref.	cms.	H.		Bar Code
778400	25X10	12/72		8411922080940

ENFRIADOR DE BOTELLAS

bottle cooler
refraichisseur à bouteilles
flaschenküher
arrefecedor de garrafas

PLASTIC

GEL

CONTIENE GEL ENFRIADOR EN SU INTERIOR
with cooler jelly inside
contenant gel réfrigérant
contém gel enfriador no interior



ref.	cms.	H.		Bar Code
786000	38x16	6/36		8411922085280

BOLSA ENFRIADOR DE BOTELLAS

bottle cooler bag
sac refroidisseur de bouteille
flaschenkühler tasche
saco de arrefecer garrafas

PVC



Reutilizable
Reusable



ref.	Cms	H.		Bar Code
739801	11X11	26	12/72	8411922441864

ENFRIADOR CONFORT

drinks cooler
refroidisseur de boissons
getränkekühler
arrefedor de bebidas



ref.	cms.		Bar Code
695042	15x21	1/6	8411922451818

INCLUYE GEL ENFRIADOR
WITH COOLER JELLY

PLASTIC



GEL REPUESTO ENFRIADOR DE BOTELLAS CONFORT

Refill gel for the Comfort bottle chiller
Recharge de gel pour refroidisseur de bouteilles Comfort
Ersatz-Gel für Flaschenkühler „Comfort“
Recarga de gel para arrefecedor de garrafas Comfort

PLASTIC

GEL



gel reutilizable
réusable gel

gel

ref.	cms.	H		Bar Code
695046	14	18,5	6/24	8411922457858

CHAMPANERA VERSALLES

champagne cooler
refraîchisseur à champagne
champagnerkühler
champanheira



INOX /
S. STEEL
201

1 mm

Apilable
Stackable



ref.	Ø	H.		Bar Code
700700	19	21	1/6	8411922453065

CUBO

utility bucket
seau
balde

INOX /
S. STEEL



ref.	cms.	lts.		Bar Code
711807	7	-	6/6	8411922434057
711809	9	-	6/6	8411922434064
711810	10	-	6/6	8411922434071
711812	12	1,00	6/72	8411922203882
711816	16	1,90	6/24	8411922622348
711820	20	3,80	6/18	8411922622355
711826	26	8,50	6/12	8411922622362

COCTELERA

cocktail shaker
shaker
shaker para cocktail

INOX /
S. STEEL
18/10



ref.	lts.		Bar Code
769100	0,7	1/12	841192209464

CUBO CHAMPÁN

champagne cooler
seau à champagne
balde de champante



INOX /
S. STEEL

ref.	cms.	lts.	📦	Bar Code
711320	20	5,00	4/4	8411922622249

CUBITERA

ice bucket
seau à glace
balde de gelo



INOX /
S. STEEL

ref.	cms.	lts.	📦	Bar Code
711414	14	1,30	6/48	8411922622256

EXPRIMIDOR MANUAL

citrus press
presse-fruits
espremedor sumos manual



NYLON

ref.	cms.	📦	Bar Code
780900	18	1/6	8411922082432

EXPRIMIDOR

juicer
presse-agrumes
presse
espremedor



MADERA
DE HAYA

BEECH
WOOD

ref.	Cms.	📦	Bar Code
747940	16	6/36	8411922453638

COCTELERA BOSTON

boston shaker
shaker boston
shaker boston

INOX /
S. STEEL
18/10



500 cc

ref.	lts.	📦	Bar Code
727300	0,5	1/6	8411922084368

VASO COCTELERA BOSTON

boston shaker glass
verre pour shaker boston
copo para shaker boston

GLASS



500 cc

ref.	lts.	📦	Bar Code
727350	0,5	1/6	8411922084375

CUCHARILLA COCKTAIL

cocktail spoon
cuillère à cocktail
cucciaino cocktail
colher cocktail

INOX /
S. STEEL



ref.	cms.	📦	Bar Code
733700	25	6/6	8411922087048

CUCHARILLA COCKTAIL C/ MACERADOR

cocktail spoon with mudler
cuillère à cocktail avec pilon
cucciaino cocktail con pestello
colher cocktail com pico

INOX /
S. STEEL



ref.	cms.	📦	Bar Code
733750	25	6/96	8411922435078

MACERADOR PARA COCKTAILS

cocktail mudler
pilon à cocktails
cocktail Rührer
pico para cocktails

INOX /
S.STEEL



ref.	cms.		Bar Code
781000	21	1/6	8411922082449

MACERADOR PARA COCKTAILS

cocktail mudler
pilon à cocktails
cocktail Rührer
pico para cocktails

MADERA
DE HAYA

BEECH
WOOD

ibili design



ref.	cms.		Bar Code
683300	25	6/72	8411922456981

BANDEJA PARA CUBITOS DE HIELO CON TAPA

ice cube tray with lid
bac à glaçons avec couvercle
eiswürfelform mit deckel
bandeja para cubos de gelo com tampa

LFGB

SILICONE

Fácil desmoldeo
Easy to release



ref.	cms.		Bar Code
860609	13X13	1/6/36	8411922449198
860621	21X14	1/6/36	8411922449204

A: 9 cubitos/cubes
B: 21 cubitos/cubes

Evita el derrame o absorción de olores
Prevents from spilling or absorbing freezer smells

BANDEJA PARA MINIHILOS

Mini ice tray
Bac à mini-glaçons
Mini-eiswürfel-form
Bandeja para gelo mini

SILICONE



ref.	Cms.	Cms		Bar Code
685500	24x12	1x1	6/36	8411922458466

MOLDE 4 BOLAS DE HIELO XL

4 ice balls moulds
moules pour 4 boules glace
form für 4 eiskugeln
4 formas para bolas de gelo

LFGB

SILICONE



ref.	∅	cms.		Bar Code
765950	5	12x12	12/48	8411922454826

MOLDES BOLAS DE HIELO Gintonic's (Set 4 pcs)

gin&tonic ice balls moulds (set 4 pcs)
 moules pour boules de glace gintonic's (set 4 pcs)
 stampi per sfera de ghiaccio gintonic's (set 4 pcs)
 formas para bolas de gelo gin-tónicos (set 4 pcs)

SILICONE PLASTIC

XL



LÍQUIDO FRÍO DURANTE MUCHO MÁS TIEMPO
 cooler liquid for much longer
 liquide froid pendant beaucoup plus longtemps
 bevanda fredda per un tempo molto più lungo
 líquido frio durante muito mais tempo



ref.	Ø	📦	Bar Code
870500	5,5	6/72	8411922086089

MOLDES BOLAS DE HIELO GINTONIC'S (SET 2PCS)

ice balls moulds gin & tonic (set 2pcs)
 moules pour boules de glace gintonic's (set 2pcs)
 stampi per sfera de ghiaccio gintonic's (set 2pcs)
 formas para bolas de gelo gin-tónicos (set 2pcs)

SILICONE PLASTIC

XXL

loli design



ref.	Ø	📦	Bar Code
870550	7,50	6/48	8411922090543

MOLDE HIELOS CUADRADO XL

square ice moulds XL
 moules pour glaçons carré XL
 stampi per ghiaccio quadrate XL
 formas para gela quadro XL

SILICONE



ref.	cms.	📦	Bar Code
870650	16x11x5	6/6/36	8411922093797

MOLDES PARA HIELO (Set 2 pcs)

ice moulds (set 2 pcs)
 moules pour glaçons (set 2 pcs)
 stampi per ghiaccio (set 2 pcs)
 formas para gelo (set 2 pcs)

SILICONE



ref.	lts	📦	Bar Code
870600	25x12	6/48	8411922086232

MEDIDOR DE LICORES DOBLE

double liqueur measurer
double doseur de liqueur
misuratore per liquore doppio
medidor de licor duplo

INOX /
S. STEEL

3cl+2cl



ref.	cls.		Bar Code
795100	2/3	12/12/144	8411922093605

MEDIDOR DE LICORES DOBLE

double liqueur measurer
double doseur de liqueur
misuratore per liquore doppio
medidor de licor duplo

INOX /
S. STEEL

3cl+5cl



ref.	cls.		Bar Code
747100	2,5/5	6/120	8411922437454

MEDIDOR DE LICOR REGULABLE

asjustable liqueur measurer
doseur de liqueur réglable
misuratore per liquore regolabile
medidor de licor regulável

PLASTIC

OZ
+
cl



ref.	cms.		Bar Code
791700	11	6/30	8411922090864

VASO MEDIDOR MINI

mini measuring cup
verre doseur mini
bicchiere misurino mini
copo medidor mini

GLASS



ref.	H	Ø		Bar Code
744800	6	5	6/72	8411922436495

MEDIDOR DE LICOR TRIPLE

triple liqueur measurer
triple doseur de liqueur
misuratore per liquore triplo
medidor de licor triplo

OZ
+
cl

INOX /
S. STEEL



ref.	cms.		Bar Code
791600	11	6/72	8411922090857

PICADOR DE HIELO

ice crusher
pileur à glace
tritaggiaccio
picador de gelo

INOX / S. STEEL PLASTIC



ref.	Ø	H		Bar Code
792400	16	26	1/6	8411922091977

SIFÓN DE SODA

soda siphon
siphon à soda
sifone soda
sifão de soda

ALUMINIUM

8 gr.



ref.	Lts.		Bar Code
744010	0,800	1/6	8411922436242

CARGAS DE SIFÓN SODA CO² (10Pcs)

soda charges co² (10pcs)
cartouches co² pour siphon soda (10pcs)
cartucce sifone co² per soda (10pcs)
botijas de sifão co² soda (10pcs)



ref.		Bar Code
744100	1/5/30	8411922436259



EXPRIMIDOR LIMAS Y LIMONES MINI

mini juice extractor for limes and lemons
 presse-citron/citron vert mini
 mini spremitore per lime e limoni
 espremedor limas e limões míni

mini



ref.	Ø	H		Bar Code
793600	7	8	12/24	8411922092615

TAPÓN + 6 IDENTIFICADORES DE COPAS

stopper + 6 glass id rings
 bouchon + 6 identificateurs de verres
 tappo + 6 segna bicchieri
 tampão + 6 identificadores de taças



PLASTIC

ref.		Bar Code
795250	6/72	8411922440591

ABRELATAS PALOMILLA

Manual can opener
 Ouvre-boîte papillon
 Flügeldosenöffner
 Abre-latas de acionamento manual



INOX /
S.STEEL

ref.	Cms		Bar Code
743100	4,2x7,6	6/120	8411922456479

COLADOR COCKTAIL

cocktail strainer
 passoire cocktail
 filtro cocktail
 coador cocktail



INOX /
S.STEEL

ref.	cms.		Bar Code
745200	12x15	6/120	8411922436549

ABRELATAS EXPLORADOR (2PC)

country tin opener (2pc)
ouvre boîtes alpiniste (2pc)
abrelatas montanhista (2pc)

NIQUEL



ref.		Bar Code
785500	12/24	8411922085211

ABRELATAS MARIPOSA

butterfly can opener
ouvre-boîtes papillon
schmetterling dosenöffner
abre-latas mariposa

METALLIC



ref.	Cms		Bar Code
785250	7X5	6/144	8411922452754

ABRELATAS MARIPOSA + DESCAPSULADOR CURVO

butterfly can opener + bottle opener
ouvre-boîtes papillon + décapsuleur
abre-latas mariposa + descapsulador

NIQUEL



ref.		Bar Code
785600	12/12	8411922085228

DESCAPSULADOR PLANO (2PC)

flat bottle opener (2pc)
décapsuleur plat (2pc)
descapsulador plano (2pc)

NIQUEL



ref.		Bar Code
785700	12/24	8411922085235

Tin Box



GALLETERO ANTIHUMEDAD

moisture-absorbing biscuit jar
boite à biscuits anti-humidité
keksdose gegen feuchtigkeit
lata de bolachas antihumidade



ref.	Ø	H	📦	Bar Code
812522	17	19,5	4	8411922448405
812523	17	19,5	4	8411922448412

A Rombos/ Rhombuses
B Rayas/ Lines

BOTE PARA TÉ

tea canister
pot à thé
teedose
lata para chá



ref.	Cms	H	📦	Bar Code
812500	7,6x7,6	10	6	8411922446562

(2XA 2XB 2XC) = 6

BOTE PARA TÉ BLUE / BOTE PARA CAFÉ BLUE

tea canister/ coffee canister
pot à thé/ pot à café
teedose/ kaffeedose
lata para chá/ lata para café



ref.	Cms	H	📦	Bar Code
812501	8,5	13	6	8411922446579
812502	8,5	13	6	8411922446586

Tea
Coffee

BOTE CON ASA WHITE

canister with handle
pot avec poignée
dose mit henkel
lata com asa



ref.	Cms	H	📦	Bar Code
812503	11	16	6	8411922446593
812504	11	16	6	8411922446609
812505	11	16	6	8411922446616
812506	13,5	19	6	8411922446623

Café/Coffee
Azucar/Sugar
Té/Tea
Galletas/Biscuits

BOTE CON CIERRE BLACK

canister with lock
pot avec fermeture
dose mit verschlus
lata com fecho



ref.	Cms	H	☐	Bar Code
812507	12x8	19	4	8411922446630
812508	12x8	19	4	8411922446647
812509	12x8	19	4	8411922446654

Café/Coffee
Azucar/Sugar
Té/Tea

BOTE GALLETERO BREAKFAST

biscuit canister
pot à biscuits
keksdose
caixa para bolachas



ref.	Cms	H	☐	Bar Code
812513	17x10	25	4	8411922446692

BOTE GALLETERO CUPCAKE

biscuit canister
pot à biscuits
keksdose
caixa para bolachas



ref.	Cms	H	☐	Bar Code
812510	13x10	20	6	8411922446661

BOTE PARA PASTA

pasta canister
pot à pâtes
nudeldose
lata para massa



B



A



ref.	Cms	H	☐	Bar Code
812520	8,5	27	6	8411922446760
812521	11	19	4	8411922446777

A
B

BOTE CÁPSULAS CAFÉ/GALLETAS

coffee capsule/biscuit canister
pot à capsules à café/biscuits
dose für kaffeekapseln/kekse
lata para cápsulas de café/bolachas



A



B



ref.	Cms	H	☐	Bar Code
812518	17x10	22	4	8411922446746
812519	14x8	19	6	8411922446753

A
B

BOLSA ISOTÉRMICA

isothermal bag
sac isotherme
thermostasche
saco isotérmico

5 Lt.



ref.	Lts.	Cms.		Bar Code
627605	5	23x19x14	6/12	8411922459647

BOLSA ISOTÉRMICA

isothermal bag
sac isotherme
thermostasche
saco isotérmico

10 Lt.



ref.	Lts.	Cms.		Bar Code
627610	10	28x16x26	6/12	8211922459654

BOLSA ISOTÉRMICA

isothermal bag
sac isotherme
thermostasche
saco isotérmico

15 Lt.



ref.	Lts.	Cms.		Bar Code
627615	15	29x20x28	6/12	8411922459661

BOLSA ISOTÉRMICA

isothermal bag
sac isotherme
thermostasche
saco isotérmico

20 Lt.



ref.	Lts.	Cms.		Bar Code
627620	20	27x24x34	6	8411922459678

BOLSA ISOTÉRMICA

isothermal bag
sac isotherme
thermostasche
saco isotérmico

30 Lt.



ref.	Lts.	Cms.		Bar Code
627630	30	31x27x39	6	8411922459685



BOLSA ISOTÉRMICA

isothermal bag
sac isotherme
thermostasche
saco isotérmico

5 Lt.



ref.	Lts.	Cms.	📦	Bar Code
627705	5	23x19x14	6/12	8411922459692

BOLSA ISOTÉRMICA

isothermal bag
sac isotherme
thermostasche
saco isotérmico

10 Lt.



ref.	Lts.	Cms.	📦	Bar Code
627710	10	28x16x26	6/12	8211922459708

BOLSA ISOTÉRMICA

isothermal bag
sac isotherme
thermostasche
saco isotérmico

15 Lt.



ref.	Lts.	Cms.	📦	Bar Code
627715	15	29x20x28	6/12	8411922459715

BOLSA ISOTÉRMICA

isothermal bag
sac isotherme
thermostasche
saco isotérmico

20 Lt.



ref.	Lts.	Cms.	📦	Bar Code
627720	20	27x24x34	6	8411922459722

BOLSA ISOTÉRMICA

isothermal bag
sac isotherme
thermostasche
saco isotérmico

30 Lt.



ref.	Lts.	Cms.	📦	Bar Code
627730	30	31x27x39	6	8411922459739



ESTUCHE-NEVERA ISOTÉRMICA PORTÁTIL PARA MEDICAMENTOS

Portable Isothermal Cooler Bag for Medicines

Étui-Glacière isotherme transportable pour médicaments
Isotherme tragbare Kühltasche für Medikamente

Estuche-nevera isotérmica portátil para medicamentos



ref.	Cms.	H		Bar Code
626500	21x10	6	6/24	8411922459050

BOLSA ISOTÉRMICA

isothermal bag
sac isotherme
thermostasche
saco isotérmico

5 Lt.



ref.	Lts.	Cms.		Bar Code
626505	5	23x19x14	6/12	8411922453270

BOLSA ISOTÉRMICA

isothermal bag
sac isotherme
thermostasche
saco isotérmico

10 Lt.



ref.	Lts.	Cms.		Bar Code
626510	10	28x16x26	6/12	8411922453287

BOLSA ISOTÉRMICA

isothermal bag
sac isotherme
thermostasche
saco isotérmico

15 Lt.



ref.	Lts.	Cms.		Bar Code
626515	15	29x20x28	6/12	8411922453294

BOLSA ISOTÉRMICA

isothermal bag
sac isotherme
thermostasche
saco isotérmico

20 Lt.



ref.	Lts.	Cms.		Bar Code
626520	20	27x24x34	6/6	8411922453300

BOLSA ISOTÉRMICA

isothermal bag
sac isotherme
thermostasche
saco isotérmico

30 Lt.



ref.	Lts.	Cms.		Bar Code
626530	30	31x27x39	6/6	8411922453317

MOCHILA ISOTÉRMICA

isothermal backpack
sac à dos isotherme
isothermer rucksack
mochila isotérmica



ref.	Lts.	Cms.	H		Bar Code
627221	21	28x20	38	6/6	8411922457261

CESTA ISOTÉRMICA

isothermal bag
sac isotherme
isotherme tasche
saco isotérmico



ref.	Lts.	Cms.	H		Bar Code
627227	27	28x47	24	6/6	8411922457278

Hella

3 capas
3 lyers

7 h.  420D POLYESTER

BOLSA ISOTÉRMICA
isothermal bag
sac isotherme
thermostasche
saco isotérmico



5 Lt.

ref.	Lts.	Cms.		Bar Code
626405	5	23x19x14	6/12	8411922453225

BOLSA ISOTÉRMICA
isothermal bag
sac isotherme
thermostasche
saco isotérmico



10 Lt.

ref.	Lts.	Cms.		Bar Code
626410	10	28x16x26	6/12	8211922453232

BOLSA ISOTÉRMICA
isothermal bag
sac isotherme
thermostasche
saco isotérmico



15 Lt.

ref.	Lts.	Cms.		Bar Code
626415	15	29x20x28	6/12	8411922453249

BOLSA ISOTÉRMICA
isothermal bag
sac isotherme
thermostasche
saco isotérmico



20 Lt.

ref.	Lts.	Cms.		Bar Code
626420	20	27x24x34	6/6	8411922453256

BOLSA ISOTÉRMICA
isothermal bag
sac isotherme
thermostasche
saco isotérmico



30 Lt.

ref.	Lts.	Cms.		Bar Code
626430	30	31x27x39	6/6	8411922453263



Camping

ACUMULADORES DE FRIO

cold accumulators
accumulateurs de froid
kühlakkus
acumuladores de frio

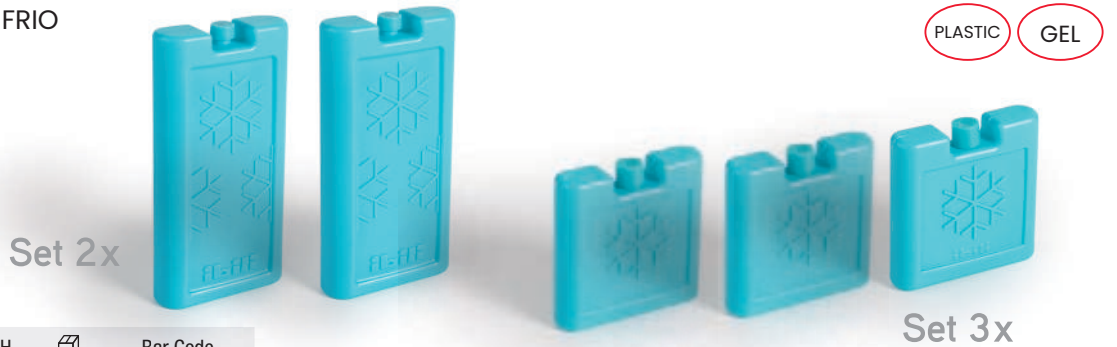

PLASTIC GEL

Set 2x

Set 3x

ref.	Lts.	Cms.	H.	📦	Bar Code
798400	0,060	7,5x7,5	1,80	6/36	8411922453430
798410	0,380	18x9,6	3,20	6/12	8411922453447

Set 3 mini / small

Set 2 grande/ big

BESUGUERA INOX.

fish wire grill
grill à poisson
grelha p/peixe

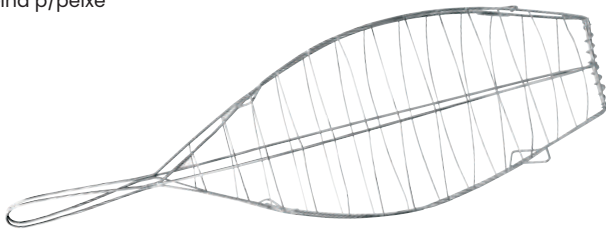

ref.	cms.	📦	Bar Code
770100	42x22	4/4	8411922072266

PARRILLA PESCADO

fish wire grill, nickel plated
grill à poisson niquelé
grelha dupla para peixe niquelado

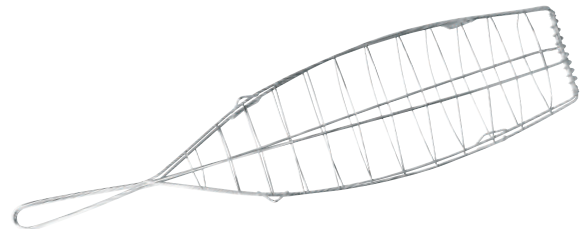

ref.	cms.	📦	Bar Code
769745	42x16	6/6	8411922161304

PARRILLA RODABALLO INOX. L

fish wire grill L
grill à poisson L
grelha p/rodvalho L

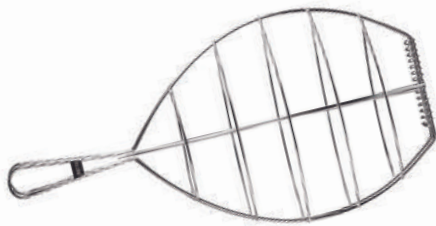

NEW

ref.	cms.	📦	Bar Code
770250	30x21	6	8411922459814

PARRILLA RODABALLO INOX. XL

fish wire grill XL
grill à poisson XL
grelha p/rodvalho XL



ref.	cms.	📦	Bar Code
770200	42x30	4/4	8411922072273

POTE

mug
gobelet
caneca

INOX / S. STEEL



ref.	H	lts.	📦	Bar Code
700308	8	0,30	6/72	8411922604252
700309	9	0,50	6/72	8411922604269
700311	11	1,00	6/72	8411922604276

FIAMBRERA CON 2 PLATOS INOX

lunch box with 2 dishes s/s
Boîte alimentaire avec 2 plats inox
lancheira com 2 pratos inox

INOX /
S. STEEL



ref.	cms.	lts.	📦	Bar Code
720614	14	0,75	1/30	8411922160581
720616	16	1,0	1/30	8411922160598
720618	18	1,3	1/20	8411922160604
720620	20	1,8	1/30	8411922160611

VASO

tumbler
timbale
copo



ref.	cms.	lts.	📦	Bar Code
711503	7,5x12	0,30	12/144	8411922622263

POTE

mug
gobelet
caneca



ref.	cms.	lts.	📦	Bar Code
102308	8	0,35	4/72	8411922137088

CUBIERTOS CAMPING INOX (set cuchara+tenedor+cuchillo)

cutlery set (spoon+fork+knife)
couverts (cuillère+fourchette+couteau)
talher (colher+garfo+faca)

INOX /
S. STEEL
18/10



ref.	cms.	📦	Bar Code
720200	17,5	12/48	8411922622478

CANTIMPLORA CON VASO ARMY

scout canteen with tumbler, ARMY
gourde avec timbale, ARMY
cantil com copo, ARMY

ALUMINIUM



ref.	lts.	📦	Bar Code
720500	1,00	6/6	8411922423617

PLATO CON ANILLA

dish with ring
assiette avec anneau
prato com anilha

INOX /
S. STEEL



ref.	cms.	H.	lts.	📦	Bar Code
711224	24	3,2	0,9	12/72	8411922622232

PLATO CAMPING HONDO CON ANILLA

deep dish with ring
assiette haute avec anneau
prato fundo com anilha

INOX /
S. STEEL



ref.	cms.	H.	lts.	📦	Bar Code
714522	22	4,0	1,0	6/72	8411922204384

CAZUELITA RACIONES

Casserole For Side Dishes
Cassolette Portions
Serviertöpfchen
Mini Caçarola Para Rações



RACIONES - SIDE DISHES - PORTIONS - PORTIONS - RAÇÕES

ref.	Cms.	H		Bar Code
942006	14	4,5	6	8411922459401

PLATO PARA HAMBURGUESA

Hamburger Plate
Plat À Hamburger
Burgerteller
Prato Para Hambúrguer



HAMBURGUESA - BURGER - HAMBURGUER - BURGER - HAMBÚRGUER

ref.	Cms.	H		Bar Code
942005	22	2,30	6	8411922459395

BANDEJA REDONDA PARA AVES-CARNE

Round Tray For Meat-Poultry
Plateau À Volaille/Viande Rond
Geflügel- Und Fleischplatte, Rund
Bandeja Redonda Para Aves-Carne



AVES/CARNE - MEAT/POULTRY - VOLAILLE/VIANDE - GEFLÜGEL/ FLEISCH - AVES/CARNE

ref.	Cms.	H		Bar Code
942004	28	2,5	6	8411922459388

PLATO PARA POSTRE

Dessert Plate
Plat À Desserts
Dessertteller
Prato De Sobremesa



POSTRE - DESSERT - DESSERT - DESSERT - SOBREMESA

ref.	Cms.	H		Bar Code
942000	18	1,7	6	8411922459304

BANDEJA PARA VERDURAS OVAL

Oval Tray For Vegetables
 Plateau À Légumes Ovale
 Gemüseplatte, Oval
 Bandeja Oval Para Verduras



VERDURAS- VEGETABLES - LÉGUMES - GEMÜSE - VERDURAS

ref.	Cms.	H		Bar Code
942002	35x24	3	6	8411922459364

BANDEJA REDONDA PARA MARISCO

Round Tray For Seafood
 Plateau À Fruits De Mer Rond
 Meeresfrüchteplatte, Rund
 Bandeja Redonda Para Marisco



MARISCO - SEAFOOD - FRUITS DE MER - MEERESFRÜCHTE - MARISCO

ref.	Cms.	H		Bar Code
942003	28	2,5	6	8411922459371

BANDEJA PARA PESCADO OVAL

Oval Tray For Fish
 Plateau À Poisson Ovale
 Fischplatte, Oval
 Bandeja Oval Para Peixe



PESCADO- FISH - POISSON - FISCH - PEIXE

ref.	Cms.	H		Bar Code
942001	35x24	3	6	8411922459357



Musgo

ACERO ESMALTADO VITRIFICADO
VITRIFIED ENAMEL STEEL
ACIER ÉMAILLÉ VITRIFIÉ
AÇO ESMALTADO VITRIFICADO



LECHERA

milk churn
bidon à lait
bidone di latte
leiteira



ref.	Ø	H	lts.	📦	Bar Code
935010	10	22	1,0	6	8411922457438

PLATO LLANO

plain dish
assiette plate
piatto piano
prato raso



ref.	cms.	H	📦	Bar Code
935122	2,3	22	6/6	8411922457445
935124	2,5	24	6/6	8411922457452
935126	2,5	26	6/6	8411922457469
935128	2,5	28	6/6	8411922457476

POTE

mug
gobelet
caneca



ref.	Ø	lts.	📦	Bar Code
935208	8	0,4	6	8411922457483

PALANGANA

wash bowl
cuvette
bacia



ref.	cms.	H	lts.	📦	Bar Code
935332	32	10	3,6	6/6	8411922457490

CUBO

Utility pail/bucket
Seau
Eimer
Balde com asa

ibili design



ref.	cms.	H.	lts.	📦	Bar Code
935511	11	11	0,72	6	8411922458848

CUBO

utility pail/bucket
seau
balde com asa



ref.	cms.	lts.	📦	Bar Code
935514	14	1,5	6/6	8411922457513

JARRA BOMBADA

belly shape pitcher
jarre bombée
jarro



ref.	H	lts.	📦	Bar Code
935625	25	2,5	6/6	8411922457520

ORINAL

chamber pot
pot de chambre
bacio



ref.	cms.	lts.	📦	Bar Code
935724	24	3,5	6/6	8411922457537

BOL CON PIE

bowl with stand
bol avec pied
tigela com pie



ref.	cms.	H.		Bar Code
935812	12	8	12/12	8411922457544

BANDEJA

platter
plat
bandeja



ref.	cms.		Bar Code
935930	30x20	6/12	8411922457551
935935	35x24	6/12	8411922457568

CAZO

saucepan
casserole
casseruola
caçarola



ref.	cms.		Bar Code
936012	12	6/6	8411922457575

PLATO HUEVOS

egg dish
plat à oeuf
prato para ovos



ref.	cms.		Bar Code
936114	14	6/6	8411922457582

BOL

bowl
bol
scodella
tigela



ref.	cms.	H.		Bar Code
936212	12	7,0	12	8411922457599
936214	14	8,5	12	8411922457605

CAFETERA CÓNICA

conical coffee pot
cafetière conique
cafeteira conica



ref.	lts.		Bar Code
935410	1,0	6/6	8411922457506

ESCURRIDERA

colander
égouttoir
scolapasta
escorredor



ref.	cms.		Bar Code
936422	22	6	8411922457629

CACILLO

soup ladle
louche
concha



ref.	cms.		Bar Code
936509	9x36	12/12	8411922457636

ESPUMADERA

skimmer
ecumoire
escumadeira de fritos



ref.	cms.		Bar Code
936610	10	12/12	8411922457643

PLATO HONDO

plain dish
assiette plate
piatto piano
prato raso



ref.	cms.	H.		Bar Code
936722	22	4	6/6	8411922457650
936724	24	4	6/6	8411922457667
936728	28	4	6/6	8411922457674

Cubos

ACERO ESMALTADO VITRIFICADO
VITRIFIED ENAMEL STEEL
ACIER ÉMAILLÉ VITRIFIÉ
AÇO ESMALTADO VITRIFICADO



NEW

Cubo
utility pail/bucket
seau
eimer
balde com asa

BLANCA



BORDEAUX



MUSGO



PECHE



PETROL



GRISE



PISTACHO



CIEL



FRAISE



ref.	cms.	H	Lts.	📦	Bar Code
903308	8	8,7	0,350	6/6	8411922459883
909308	8	8,7	0,350	6/6	8411922459890
935508	8	8,7	0,350	6/6	8411922459906
942100	8	8,7	0,350	6/6	8411922459913
942101	8	8,7	0,350	6/6	8411922459920
942102	8	8,7	0,350	6/6	8411922459937
942103	8	8,7	0,350	6/6	8411922459944
942104	8	8,7	0,350	6/6	8411922459951
942105	8	8,7	0,350	6/6	8411922459968

BLANCA
BORDEAUX
MUSGO
PECHE
PETROL
GRISE
PISTACHO
CIEL
FRAISE



Plato de huevos

ACERO ESMALTADO VITRIFICADO
VITRIFIED ENAMEL STEEL
ACIER ÉMAILLÉ VITRIFIÉ
AÇO ESMALTADO VITRIFICADO



NEW

Plato de huevos

egg dish

plat à œuf

serviertöpfehen

prato para ovos

PECHE



PETROL



GRISE



PISTACHO



CIEL



FRAISE



ref.	cms.	H	Lts.		Bar Code
942200	14	4,5	0,400	6/6	8411922459975
942201	14	4,5	0,400	6/6	8411922459982
942202	14	4,5	0,400	6/6	8411922459999
942203	14	4,5	0,400	6/6	8411922460001
942204	14	4,5	0,400	6/6	8411922460018
942205	14	4,5	0,400	6/6	8411922460025

PECHE
PETROL
GRISE
PISTACHO
CIEL
FRAISE



Cuencos

ACERO ESMALTADO VITRIFICADO
VITRIFIED ENAMEL STEEL
ACIER ÉMAILLÉ VITRIFIÉ
AÇO ESMALTADO VITRIFICADO

FABRICACIÓN ARTESANAL
HAND MADE



CUENCO PARA SALSAS MINI

Mini sauce bowl

Mini récipient pour sauces

Saucenschüssel mini

Tigela para molhos mini



PECHE

PETROL

GRISE



PISTACHO

CIEL

FRAISE



BORDEAUX

BLANCA

MUSGO



ref.	Lts.	Ø	H	📦	Bar Code
941600	0,125	7	4	12	8411922456721
941650	0,230	9	4,5	12	8411922458862
941601	0,125	7	4	12	8411922456738
941651	0,230	9	4,5	12	8411922458879
941602	0,125	7	4	12	8411922456745
941652	0,230	9	4,5	12	8411922458886
941603	0,125	7	4	12	8411922456752
941653	0,230	9	4,5	12	8411922458893

PECHE

PETROL

GRISE

PISTACHO

ref.	Lts.	Ø	H	📦	Bar Code
941604	0,125	7	4	12	8411922456769
941654	0,230	9	4,5	12	8411922458909
941605	0,125	7	4	12	8411922456776
941655	0,230	9	4,5	12	8411922458916
941606	0,125	7	4	12	8411922456783
941656	0,230	9	4,5	12	8411922458923
941607	0,125	7	4	12	8411922456790
941657	0,230	9	4,5	12	8411922458930
936312	0,125	7	4	12	8411922457612
941658	0,230	9	4,5	12	8411922458947

CIEL

FRAISE

BORDEAUX

BLANCA

MUSGO

Sena

ACERO ESMALTADO VITRIFICADO
VITRIFIED ENAMEL STEEL
ACIER ÉMAILLÉ VITRIFIÉ
AÇO ESMALTADO VITRIFICADO

FABRICACIÓN ARTESANAL
HAND MADE



POTE
mug
gobelet
caneca



ref.	cms.	lts.		Bar Code
918508	8	0,40	12/12	8411922204599

PALANGANA
wash bowl
cuvette
bacia



ref.	cms.	lts.		Bar Code
918632	32	3,60	6/6	8411922204605

ORINAL
chamber pot
pot de chambre
bacio



ref.	cms.	lts.		Bar Code
919322	22	2,70	6/6	8411922204674

JARRA BOMBADA
belly shape pitcher
jarre bombée
jarro bombado



ref.	lts.		Bar Code
919225	2,50	6/6	8411922204667

CAFETERA CÓNICA
conical coffee
pot cafetière conique
cafeteira conica



ref.	lts.		Bar Code
918710	1,00	6/6	8411922204612

TETERA
tea pot
théière
chaleira



ref.	lts.		Bar Code
918807	0,70	6/6	8411922204629

Roja

FABRICACIÓN ARTESANAL
HAND MADE



PLATO DE HUEVOS
egg dish
plat à oeuf
prato para ovos



ref.	cms.	lts.		Bar Code
912214	14	0,40	12/12	84119222061147
912218	18	0,90	12/12	8411922204933

POTE
mug
gobelet
caneca



ref.	cms.	lts.		Bar Code
911006	6	0,20	6/6	8411922009064
911008	8	0,40	12/12	8411922009088
911010	10	0,70	12/12	8411922009101

CAFETERA CÓNICA

conical coffee pot
cafetière conique
cafeteira conica



ref.	lts.		Bar Code
910250	0,50	6/6	8411922002508
910210	1,00	6/6	8411922002102

CAFETERA TURCA

turkish coffee pot
cafetière turcque
cafeteira turca



ref.	lts.		Bar Code
910103	0,35	6/6	8411922087796
910145	0,50	6/6	8411922001501

TETERA

tea pot
théière
chaleira



ref.	lts.		Bar Code
910350	0,50	6/6	8411922003505
910370	0,75	6/6	8411922003758

CAFETERA CON FILTRO

coffee pot with filter
cafetière avec filtre
cafeteira com filtro



ref.	lts.		Bar Code
910815	1,50	4/4	8411922008159

CAFETERA PAVA

kettle
bouilloire
cafeteira pava



ref.	lts.		Bar Code
910410	1,00	6/6	8411922004106

LECHERA DE SERVIR

milk pitcher
pot à lait à servir
leiteira



ref.	lts.		Bar Code
910550	0,50	6/6	8411922005509

AZUCARERO CON TAPA

sugar bowl with lid
sucrier avec couvercle
açucareiro com tampa



ref.	lts.		Bar Code
910650	0,50	6/6	8411922006506

CUBO

utility pail/bucket
seau
balde com asa



ref.	cms.	lts.		Bar Code
911514	14	1,50	6/6	8411922034141
911522	22	5,50	6/6	8411922034226

Bordeaux

FABRICACIÓN ARTESANAL
HAND MADE



TAZA + PLATILLO

mug with plate
gobelet avec assiette
caneca con prato



ref.	cms.	Lts.		Bar Code
908405	5-8,5	0,075	6	8411922438055

BOL

bowl
bol
scodella
tigela



ref.	cms.	H		Bar Code
908312	12	7	12	8411922438017
908314	14	8,5	12	8411922438024
908316	16	9	12	8411922438031
908320	20	11,5	12	8411922438048

FRUTERO

fruit bowl
coupe à fruits
obstschale
frutero



ref.	∅	H		Bar Code
905926	26	6	6	8411922454932

PANERA

bread basket
plat à pain
brotkasten
paneira



ref.	∅	H		Bar Code
905924	24	4	6	8411922454956

TAZA

mug
gobelet
tasse
caneca



ref.	cms.	H.	Lts.		Bar Code
907407	7	6	0,20	6	8411922447255
907408	8	6	0,26	6	8411922447262

PLATILLO

plate
assiette
unterteller
prato



ref.	cms.		Bar Code
907512	12	12	8411922447279
907514	14	12	8411922447286

BOWL CON ASA

bowl with handle
bowl avec anse
tigela com asa



ref.	cms.		Bar Code
909114	14	6	8411922438147

COCOTTE OVAL

cocotte ovale
oval cocotte
cocotte ovale
cocotte oval

special



vitro



gas



ref.	cms.	H.		Bar Code
907634	36x27	13	1	8411922441055



VASO MEDIDOR

measuring jar
verre mesurer
copo medidor



ref.	cms.	Lts.		Bar Code
908612	12	1	6	8411922438079

CAZO CON PICO

saucepan with spout
casserole avec bec verseur
casseruola 1 manico
caçarola com bico



ref.	cms.		Bar Code
909210	10	6	8411922438161

OLLA MINI

mini stock pot
marmite mini
pentola mini
panela mini



ref.	cms.	Lts.		Bar Code
909612	12	1,2	6	8411922438215

POTE

mug
gobelet
caneca



ref.	cms.	Lts.		Bar Code
909407	7	0,30	6	8411922438178
909408	8	0,40	12	8411922438185

PLATO LLANO

dish plain
assiette plate
prato raso



ref.	cms.	📦	Bar Code
908118	18	6	8411922441147
908120	20	6	8411922460032
908122	22	6	8411922437966
908124	24	6	8411922437973
908126	26	6	8411922437980
908128	28	6	8411922437997

NEW

PLATO HONDO

dish
assiette
prato



ref.	cms.	H	📦	Bar Code
908022	22	4	6	8411922437928
908024	24	4	6	8411922437935
908028	28	4	6	8411922437942
908032	32	4	6	8411922437959

BANDEJA

oval platter
plat ovale
bandeja oval



ref.	cms.	📦	Bar Code
908725	25	6	8411922438086
908730	30	6	8411922438093
908736	36	6	8411922438109

ESCURRIDERA

colander
égouttoir
scolapasta
escorredor



ref.	Ø	📦	Bar Code
910222	22	6	8411922439434

ESPUMADERA

skimmer
ecumoire
escumadeira de fritos



ref.	cms.	📦	Bar Code
909010	10	12	8411922438130

CACILLO

soup ladle
louche
concha



ref.	cms.	📦	Bar Code
908906	6	12	8411922438208
908909	9	12	8411922438123

CUCHARA

spoon
cuillère
colher



ref.	cms.	📦	Bar Code
907800	10	6	8411922440645

BOL CON PIE

bowl with stand
bol avec pied
tigela com pie



ref.	cms.	H	📦	Bar Code
909512	12	8	12	8411922438192

SARTÉN PRESENTACIÓN

Presentation pan
Poêle de présentation
Präsentierpfanne
Frigideira apresentação



ref.	Cms.		Bar Code
907214	14	6	8411922456813

PLATO DE HUEVOS

egg dish
plat à oeuf
prato para ovos



ref.	cms.		Bar Code
909814	14	12	8411922438239
909818	18	6	8411922439458

CAFETERA CÓNICA

conical coffee pot
cafetière conique
cafeteira conica



ref.	Lts.		Bar Code
908501	1	6	8411922438062

TETERA

tea pot
théière
chaleira



ref.	Lts.		Bar Code
908805	0,5	6	8411922438116

FLANERO INDIVIDUAL BORDEAUX

Cream caramel mould
Moule à crème caramel
Puddingform
Forma de pudim flan



ref.	cms.	H.	Lts.		Bar Code
907108	8	6	0,25	6	8411922458060

ORINAL

chamber pot
pot de chambre
bacio



ref.	cms.	Lts.		Bar Code
908224	24	3,5	6	8411922438000

PALANGANA

wash bowl
cuvette
bacia



ref.	cms.	Lts.		Bar Code
910132	32	3,6	6	8411922438260

JARRA BOMBADA

belly shape pitcher
jarre bombée
jarro



ref.	Lts.		Bar Code
910015	2,5	6	8411922438253

COLGADOR DE UTENSILIOS

wall rack
penderie murale
suporte parede



ref.	cms.	H.		Bar Code
907700	33	47	4	8411922440973

LECHERA

milk churn
bidon à lait
bidone di latte
Leiteira



ref.	Ø	H	Lts.		Bar Code
913010	10	22	1	6/6	8411922439441

MANTEQUILLERA

butter dish
beurrer
butterdose
manteigueira



libi design

ref.	Cms.	H		Bar Code
907300	17x12	6	6	8411922449723

FUENTE HONDA OVAL

deep oval platter
plat ovale profonde
bandeja funda oval



ref.	cms.		Bar Code
907932	32x25,5	6	8411922440614

RUSTIDERA C/ ASAS

roast pan with handles
plat à rôtir avec anses
tabuleiro com asas



ref.	cms.	H		Bar Code
909932	32	7	6	8411922438246

CUBO

utility pail/bucket
seau
balde com asa



ref.	cms.	Lts.		Bar Code
909314	14	1,5	6	8411922438154

CUBO

Utility pail/bucket
Seau
Eimer
Balde com asa



ref.	cms.	H.	Lts.		Bar Code
909311	11	11	0,72	6	8411922458831

POTE

Mug
Gobelet
Becher
Caneca



ref.	Cms.	Lts.		Bar Code
925008	8	0,40	12/12	8411922455786

TAZA

Mug
Gobelet
Tasse
Caneca



ref.	Cms.	Lts.		Bar Code
925108	8	0,26	6	8411922455793

OLLA MINI

Mini stock pot
Marmite mini
Kochtopf mini
Panela mini



ref.	Cms.	Lts		Bar Code
925210	10			8411922455809

CAFETERA CÓNICA

Conical coffee pot
Cafetière conique
Kaffeekanne konisch
Cafeteira conica



ref.	Lts.		Bar Code
925301	1	6	8411922455816

CUBO

Bucket
Seau
Eimer
Balde com asa



ref.	Cms.	Lts.		Bar Code
925414	14	1,5	6	8411922455823

CAZO POP

Saucepan
Casserole
Stielkasserolle
Çaçarola



ref.	Cms.		Bar Code
925510	10	6	8411922455830

Blanca

ACERO ESMALTADO VITRIFICADO
VITRIFIED ENAMEL STEEL
ACIER ÉMAILLÉ VITRIFIÉ
AÇO ESMALTADO VITRIFICADO

FABRICACIÓN ARTESANAL
HAND MADE



TAZA + PLATILLO

mug with plate
gobelet avec assiette
caneca com prato



ref.	cms.	Lts.	📦	Bar Code
903000	5+8,5	0,075	6	8411922437867

POTE

mug
gobelet
caneca



ref.	cms.	lts.	📦	Bar Code
903005	5	0,075	6/6	8411922433371
903007	7	0,30	6/6	8411922433388
903008	8	0,40	12/12	8411922204506

FUENTE RECTANGULAR HONDA

rectangular deep platter
plat rectangulaire profonde
bandeja profunda



ref.	cms.	H	📦	Bar Code
905015	15	4	6	8411922437881
905017	17	4,6	6	8411922437898
905020	20	5,8	6	8411922437904
905022	22	6	6	8411922437911
905027	27	6	6	8411922441208

FUENTE HONDA OVAL

deep oval platter
plat ovale profonde
bandeja funda oval



ref.	cms.	📦	Bar Code
905232	32x25,5	6	8411922440607

CAZO CÓNICO CON PICO

conical saucepan with spout
casserole conique avec bec verseur
casseruola conica 1 manico
caçarola conica com bico



ref.	cms.		Bar Code
904410	10	6/6	8411922437270
904012	12	6/6	8411922433395

BOWL CONICO

bowl
bol
scodella
tigela



ref.	Ø		Bar Code
905116	16	6	8411922438451
905120	20	6	8411922438468
905124	24	6	8411922438475



PLATO HONDO

dish
assiette
prato



ref.	cms.	H.		Bar Code
912922	22	4	6/6	8411922202472
912924	24	4	6/6	8411922204209
912928	28	4	6/6	8411922072099
912932	32	4	6/6	8411922072105
912936	36	4	6/6	8411922072112

PLATO LLANO

plain dish
assiette plate
piatto piano
prato raso



ref.	H.	cms.		Bar Code
901118	1,7	18	6/6	8411922441154
NEW 901120	2,0	20	6/6	8411922459876
901122	2,3	22	6/6	8411922434545
901124	2,5	24	6/6	8411922434552
901126	2,5	26	6/6	8411922435894
901128	2,5	28	6/6	8411922083460

RUSTIDERA

roast pan
plat à rôtir
bratreine
tabuleiro



ref.	cms.		Bar Code
905437	37x24x7	6	8411922447040

BANDEJA OVALADA

oval platter
plat ovale
bandeja oval



ref.	Cms.		Bar Code
903925	25x17,5	6/6	8411922434569
903930	30x20	6/12	8411922077797
903935	35x24	6/12	8411922077803
903940	40x27	6/12	8411922077810

JARRA BOMBADA

belly shape pitcher
jarre bombée
jarro



ref.	H.	lts.		Bar Code
903425	25	2,50	6/6	8411922204544

PALANGANA

wash bowl
cuvette
bacia



ref.	cms.	H.	lts.		Bar Code
903132	32	10	3,60	6/6	8411922204513

ORINAL

chamber pot
pot de chambre
bacio



ref.	cms.	lts.	📦	Bar Code
903522	22	2,70	6/6	8411922204551
903524	24	3,50	6/6	8411922205787

BOL CON PIE

bowl with stand
bol avec pied
tigela com pie



ref.	cms.	H	📦	Bar Code
903812	12	8	12/12	8411922204582

CAFETERA CÓNICA

conical coffee pot
cafetière conique
cafeteira conica



ref.	lts.	📦	Bar Code
903210	1,00	6/6	8411922204520

PLATO DE HUEVOS

egg dish
plat à oeuf
prato para ovos



ref.	cms.	📦	Bar Code
904114	14	6/6	8411922433401
904116	16	6/6	8411922437256
904118	18	6/6	8411922437263

ESPUMADERA

skimmer
ecumoire
escumadeira de fritos



ref.	∅	📦	Bar Code
911910	10	12/12	8411922206586

CACILLO

soup ladle
louche
concha



ref.	cms.	📦	Bar Code
911806	6x25	6/6	8411922436891
911809	9x36	12/12	8411922206593

CACILLO ACEITUNAS

olive ladle
louche à olives
colher para azeitonas



ref.	∅	📦	Bar Code
911850	8	12/12	8411922072129

CUCHARON

spoon
cuillère
colher



ref.	Cms	📦	Bar Code
904500	35	6	8411922440638

CUBO

bucket
seau
balde



ref.	Cms.	lts.		Bar Code
903314	14	1,5	6/6	8411922204537

CUBO

Utility pail/bucket
Seau
Eimer
Balde com asa



ref.	cms.	H.	Lts.		Bar Code
903311	11	11	0,72	6	8411922458824

OLLA MINI

mini stock pot
marmite mini
pentola mini
panela mini



ref.	Cms.	H.	lts.		Bar Code
902910	10	10		6/6	8411922435504

CACEROLA RECTA MINI

mini straight casserole
faitout droite mini
casseruola diritta mini
tacho reta mini



ref.	Ø	H.	Lts.		Bar Code
902712	12	6	0,360	6/6	8411922436907

BOWL

bowl
bol
scodella
tigela



ref.	Ø	H.		Bar Code
904212	12	7,0	12	8411922436167
904214	14	8,5	12	8411922436174
904216	16	9,0	12	8411922436181
904220	20	11,5	12	8411922436198

BANDEJA REDONDA C/ASAS

round plate with handle
plat rond avec anses
piatto tondo con manici
bandeja redonda com asas



ref.	Ø	H.		Bar Code
904122	22	4	6/6	8411922436631
904124	24	4	6/6	8411922436648

POTE

mug
gobelet
caneca

Surtido / Assorted 2A + 2B + 2C + 2D = 8



ref.	Cms.	lts.		Bar Code
904808	8	0,4	8/8	8411922435535

ESCURRIDOR

colander
égouttoir
scolapasta
escorredor



ref.	cms.		Bar Code
911422	22	6	8411922033229

COLADOR

strainer
passoire
scolapiatti
passador



ref.	cms.		Bar Code
912518	18	12	8411922064186

LECHERA

milk churn
bidon à lait
bidone di latte
leiteira



ref.	Ø	H	Lts.		Bar Code
904301	10	22	1,0	6	8411922436204
904302	13	26	2,0	6	8411922447026

BOWL CON ASA

bowl with handle
bowl avec anse
tigela com asa



ref.	Cms.		Bar Code
903814	14	6/6	8411922435528

JARRA DE SERVIR

serving pitcher
pichet
krug
jarro de servir



ref.	Lts.	H.		Bar Code
904609	0,75	12,5	6	8411922447163

OLLA MINI

mini stock pot
marmite mini
pentola mini
panela mini



ref.	Ø	H.	Lts		Bar Code
902812	12	10	1,2	6/6	8411922436914

COLGADOR DE UTENSILIOS

wall rack
penderie murale
suporte parede



ref.	cms.	H.		Bar Code
905300	33	47	4	8411922440980

TAZA
mug
gobelet
tasse
caneca



ref.	cms.	Lts.		Bar Code
904707	7	0,20	6	8411922447217
904708	8	0,26	6	8411922447224

PLATILLO
plate
assiette
unterteller
prato



ref.	cms.		Bar Code
905608	8,5	12	8411922457216
905612	12	12	8411922447231
905614	14	12	8411922447248

MANTEQUILLERA

Butter Dish
Beurrier
Butterdose
Manteigueira

ibili design



ref.	Cms	H		Bar Code
905800	17x12	6	6	8411922449716

EMBUDO

funnel
entonnoir
trichter
funil



ref.	Ø	H		Bar Code
905713	13	16	12	8411922449709

FLANERO INDIVIDUAL BLANCA

Cream caramel mould
Moule à crème caramel
Puddingform
Forma de pudim flan



ref.	cms.	H.	Lts.		Bar Code
901008	8	6	0,25	6	8411922458053

SARTÉN PRESENTACIÓN

Presentation pan
Poêle de présentation
Präsentierpfanne
Frigideira apresentação



ref.	Cms.		Bar Code
906214	14	6	8411922456806

FRUTERO

fruit bowl
coupe à fruits
obstschale
frutero



ref.	Ø	H		Bar Code
902626	26	6	6	8411922454925

PANERA

bread basket
plat à pain
brotkasten
paneira



ref.	Ø	H		Bar Code
902624	24	4	6	8411922454949

Versalles

FABRICACIÓN ARTESANAL
HAND MADE

PLATO LLANO

dish plain
assiette plate
prato raso



ref.	Cms.	📦	Bar Code
920022	22	6	8411922440652
920024	24	6	8411922440669

BANDEJA

oval platter
plat ovale
bandeja oval



ref.	Cms.	📦	Bar Code
921025	25	6/6	8411922440843
921030	30x20	6/12	8411922440850
921036	36x24	6/12	8411922440867

POTE

mug
gobelet
caneca



ref.	Cms.	Lts.	📦	Bar Code
920308	8	0,4	12	8411922440706

AZUCARERO CON TAPA

sugar bowl with lid
sucrier avec couvercle
açucareiro tampa



ref.	Lts.	📦	Bar Code
921405	0,5	6	8411922440911

CUBO

bucket
seau
balde



ref.	Cms.	Lts.	📦	Bar Code
920414	14	1,5	6	8411922440713

BOL CON PIE

bowl with stand
bol avec pied
tigela com pie



ref.	Cms.	H.	📦	Bar Code
920514	14	8	12	8411922440737

BOL

bowl
bol
scodella
tigela



ref.	Cms.	H.	📦	Bar Code
920716	16	9,0	12	8411922440775

PLATO DE HUEVOS

egg dish
plat à oeuf
prato para ovos



ref.	Cms.	📦	Bar Code
920614	14	6	8411922440744

COLGADOR DE UTENSILIOS

wall rack
penderie murale
suporte parede



ref.	Cms.	H.		Bar Code
921700	33	47	4	8411922440966

PLATO PARA POSTRE

dessert dish
plat à dessert
prato de sobremesa



ref.	cms.	H.		Bar Code
920018	18	1,7	6	8411922441161

CUCHARÓN

spoon
cuillère
colher



ref.	Cms.		Bar Code
921600	35	6	8411922440959

CAZO

soup ladle
louche
concha



ref.	Cms.		Bar Code
921106	6x25	12	8411922440874
921109	9x36	12	8411922440881

ESPUMADERA

skimmer
ecumoire
escumadeira de fritos



ref.	Ø		Bar Code
921210	10	12	8411922440898

Petrol

BANDEJA DE SERVICIO

Serving tray
Plateau de service
Serviertablett
Bandeja de serviço

ibili design



vintage



ref.	cms.	H.		Bar Code
975500	36x21	2	6	8411922459333

Expositor

EXPO SARTENES COLUMNA

column exhibitor
exposant colonne
expositor de coluna

NEW



ref.	cms	H	Bar Code	
000999	45x45	1,80	8411922458350	1

EXPOSITOR GENERAL RECTO

straight stand
exposant droit
expositor linha reta

METALLIC

20
ganchos
hooks
crochels
ganchos

ibili design

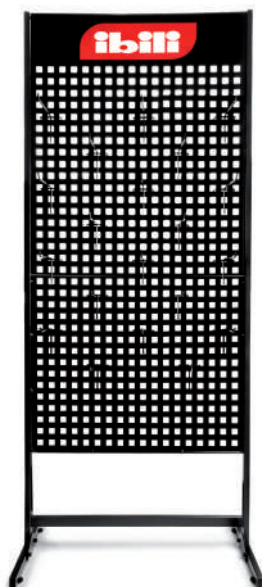

ref.	cms.	H	
000888	78	185	1

EXPOSITOR SARTENES CURVADO

curved stand
exposant courbe
expositor curvo

METALLIC

12
ganchos
hooks
crochels
ganchos

ibili design



ref.	cms.	H	
000887	57	185	1

GANCHOS

hooks
crochels
ganchos

ref.	cms.	
000008	22	6

BANDEJA PARA EXPOSITOR

display tray
plateau pour présentoir
warenregal
bandeja para expositor



ref.	cms.	
000888B	78	1



Índice alfabético



A

Ablanda carne	327
Abrebotes	304, 305, 334, 354
Abrechapas	374
Abrelatas	261, 334, 353, 383, 384
Abreostras	334, 35
Abridor de champán	368
Aceitera	248, 307, 308, 309
Accesorio ravioli	280
Acumulador de frío	391
Adaptador inducción-vitro	20, 203
Adaptador para cabezal soplete	125
Adaptadores	155
Afilador	330, 331
Aguja de bridar	313
Aireador de vino	372
Airpot	235, 373
Alfombrilla escurridor	305
Anillo antigoteo	372
Anillas niveladoras	189
Aros presentación	99, 100, 101
Asador de pollos	321
Asas	8, 29, 57
Atril	315
Azucarero	311, 401, 414

B

Bajoplato	289
Bandeja	183, 184, 287, 289, 393, 394, 396, 404, 409, 414
Bandeja de mantequilla	247, 406, 413
Bandeja horno	62, 63, 64, 65, 71, 84, 91, 107, 108
Bandeja de servicio	415
Banneton	106
Báscula	161
Bases	191
Baterías	13
Batidor	171, 173, 174, 214, 353
Biberones	160
Blonda	183, 184
Bol	108, 117, 160, 241, 242, 288, 396, 399, 402, 403, 404, 409, 410, 412, 414
Bol semiesferico	117
Bola para cocido	320
Bolas de hielo	379, 380
Bolas de té	216
Bolas decantador	372
Bolas repostería	186
Bolsa filtro para leche	323
Bolsa isotermica	387, 388, 389, 390
Bolsa para cocido	320
Bolsa para fruta	341
Bolsa para grill	321
Bolsas para asar	321
Bolsas para pan	285
Bomba de vacío	369
Boquillas	151, 152, 153, 154, 155, 156, 157
Bote residuos	312
Botes	255, 385, 386
Botella	220, 221, 222, 223, 224, 224, 225, 226, 227, 228, 363, 364
Brochetas	349
Buñolera	130, 131

C

Cacerola	6, 7, 8, 9, 10, 11, 13, 14, 15, 16, 18, 411
----------	---

Cacerola horno	21
Cacerola vapor	11
Cacillo	351, 353, 354, 356, 357, 358, 359, 360, 36, 362, 396, 404, 410, 415
Cacillo aceitunas	358, 410
Cafetera cónica	396, 400, 401, 405, 410
Cafetera-émbolo	204
Cafetera express	200, 201, 202, 203
Cafetera pava	212, 213, 401
Cafetera silbante	213
Cafetera turca	401
Cajas	119, 120, 184, 185, 215
Calentador teterras	212
Cantimploras	392
Cápsula bombón	180, 181, 185, 186
Cápsula madalena	178, 179, 180, 181, 185, 186
Cápsulas cupcake	186
Cargas sifón nata	127
Cargas sifón soda	382
Cascanueces	314
Cazo	8, 19, 10, 11, 12, 13, 15, 16, 17, 18, 396, 403, 407, 409
Cazo baño maria	117
Cazo freidor	12
Cazos de medidas	168
Cazuelita	13, 17, 393
Centrifugadora ensalada	337
Cepillo limpiacornetes	155
Cepillo limpiador botellas	235
Cepillo para cacerolas	343, 344
Cepillo para verduras	329
Cesta de huevos	300
Cesta para pan	286
Cestillo freidor	52, 325
Cestillo vapor	11, 21, 320
Churrasquera	48
Churrera	128, 129
Clips	339
Cocotte	14, 17, 403
Coctelera	378
Cocedor pasta/espárragos	325
Colador	215, 287, 300, 301, 412
Colador cocktail	383
Colgador de trapos	341
Colgador mural	360, 406, 412, 415
Comprador de tartas	164
Conservador de frutas	238
Contenedores	245, 248, 249, 250, 251, 252, 253, 254, 256, 312
Cortacápsulas	369
Cortador crostata	176
Cortador de donuts	129
Cortador de ensaladilla	265
Cortador de foie	295
Cortador de limones	262
Cortador de manzanas	290
Cortador de melón y piñas	291
Cortador de raviolis	278, 278
Cortador de sandía	292
Cortador de verduras	26, 262, 267, 327, 335
Cortador en virutas	116
Cortador para chebakia	121
Cortahuevos	326
Cortamasas	138
Cortapastas	135, 137, 139, 140, 141, 142, 143, 144, 145, 146, 146, 147, 148, 149
Cortapatatas	261, 262, 264
Cortapiñas	291
Cortapizza	334, 335, 354
Cortaquesos	294, 295, 355
Cubiertos	254, 259, 260, 392
Cubitera	378
Cubo	325, 377, 378, 395, 396, 401, 406, 407, 411, 414

Cubo champán	377, 378
Cubo para reciclaje	342
Cuchara	171, 172, 173, 240, 351, 353, 356, 357, 358, 359, 360, 361, 362, 396, 404, 410, 415
Cuchara esferificaciones	313
Cuchara medidas	168
Cuchara pasta	352, 353, 356, 357, 358, 359, 360, 361, 362
Cucharilla cocktail	378
Cucharillas presentación	313
Cuchilla para pan	106
Cuchillo fondant	196
Cuchillo	239, 257, 258, 259, 272, 273
Cuchillo para queso	293, 352
Cuenco	399

D

Decoradores	156, 157, 158, 215
Decorador de calabazas	327, 332
Decoradores verduras	261, 336
Descapsulador	354, 384
Descorazonador	290, 354
Decorazonador pimientos	292
Descalcificador de teteras	214
Descorazonador tomate	355
Desgranador	290
Deshuesador de cerezas	266, 292, 328
Deshuesador de mango	292
Difusor para gas	21
Dispensador de agua	343
Dispensador de aliño	254, 309, 310
Dispensador de cápsulas	219
Dispensador de detergente	343
Dispensador de film/papel	304
Dispensador de helado	124, 354
Dispensador de miel	311, 346
Dispensador de queso	311

E

Eco	
Elimina grasas	284
Encendedor	344
Enfriabotellas	373, 376, 377
Enfriador de latas	376
Envoltorio para cupcake	182
Embudo	326, 342, 413
Embudo confituras	326
Empanadera	97
Envasador de capsulas	218
Escalfador	92, 274
Escanciador	371, 374
Escurrecubiertos	298
Escurridor	287, 396, 404, 412
Escurridor de platos	305
Espátula	163, 164, 165, 166, 167, 168, 171, 351, 352, 353, 356, 357, 358, 359, 360, 361, 362
Espátula para crepes	132, 348, 356
Espátula para mantequilla	354
Espátula para tortillas	356
Espatula plancha	357
Espátula repostería	163, 165
Espatula tamagoyaki	43
Especiero	338
Espolvoreador	169
España esmeril	343
España limpiadora sifones	235
Espumadera	283, 351, 353, 356, 357, 358, 359, 360, 361, 362, 396, 404, 410, 415

Estecas	189
Estuche de vapor	273, 274
Etiquetas para vino	374
Expositor	416
Exprimidor	289, 314, 378

F

Fiambreira	254
Filtros	211, 215, 216, 320
Flanero	72, 73, 74, 75, 76, 78, 79, 80, 83, 86, 90, 91, 96, 102, 108, 405
Fondant	188
Fondue	115
Freidora	12, 36, 39, 42, 46, 51
Frutero	402, 413
Fuente	406, 408
Funda para rodillo	323
G	
Gafas	330
Gas	125, 126
Grasera	306
Grill	26, 30, 32, 33, 34, 35, 36, 37, 39, 42, 45
Grill piedra	281
Guardaverduras	345
Guía cortabizcochos	186, 187
Guía cortacebollas	329

H

Harinero	301
Hervidor	12, 16, 205
Hilador de huevo	132
Hilo de cocina	322
Huevera	300

I

Infusor	215, 216
Inyector	321

J

Jamonero	350
Jarra	204, 205, 287, 289, 364, 395, 400, 405, 406, 409, 412
Jarra medidas	169
Jarra termo	234
Juego de vino	373

K

Kit barritas enegeticas	275
Kit croquetas	134
Kit fiambre	275
Kit para mate	214
Kit petit choc	149
Kit profiteroles	132

L

Lamina antiadherente	66
Laminador ajos	263
Laminador de aguacate	291
Laminador de trufa	293
Lapiz decorador	158
Lata termo	230

Lechera	287, 395, 406, 412
Lechera servir	401
Librador	294
Lira para queso	294, 295
Lira para tartas	187
Lunch away	253
Lupa para frigorífico	284

M

Macerador	379
Madera	346
Malla para carne	322
Mandolina	263
Mangas repostería	156, 157, 158, 159, 160
Mano para chino	340
Manopla	341
Maquina para croquetas	134
Máquina de pasta	280
Marcador de copas	372, 383
Marcador de galletas	150
Marcador de panes	150
Marcador de tartas	187, 188
Mazo tenderizador	347, 354
Mechador	355
Medidor de licor	381
Medidor de spaguetti	280
Molde 3d	109, 110, 194, 195
Molde alto	70, 72, 74, 76, 79, 84, 92, 104, 108, 190
Mole angel food	102
Molde anodizado	190, 191
Molde aspic	93
Molde baguette	89, 97
Molde bajo	74
Molde bola	110
Molde bolso	111
Molde bombón	112, 113, 114, 115
Molde à bûche	98, 113
Molde cake	70, 72, 73, 74, 76, 77, 78, 79, 80, 84, 85, 88, 91, 94, 97, 103, 104, 105, 107, 191
Molde cake pop	82
Molde calabaza	83, 86
Molde canelé	94
Molde canutillo	92, 97, 103
Molde cavidades	80, 83
Molde chocolate	109, 114, 115, 116
Molde corazón	85, 92, 94, 109, 111
Molde cuadrado	70, 85, 91, 107, 190
Molde desmontable	70, 72, 91, 75, 77, 85, 88, 91, 94, 96, 103, 191
Molde desmontable con base de cristal	77
Molde doughnut	78, 86
Molde empanadillas	133
Molde extensible	98
Molde falafel	276
Molde florón	130
Molde gelatina	186
Molde ginger	111
Molde gofres	132
Molde gominolas	81, 111
Molde halloween	86
Molde hamburguesa	324
Molde helados	122, 123
Molde hielo	379, 380
Molde huevo	93, 110, 113, 133
Molde huevo de pascua	92
Molde inclinado	87
Molde joyero	109
Molde kugelhof	90
Molde letras	188
Molde madalena	92
Moldes mini	86, 94
Molde muffin	71, 76, 80, 84, 89, 90
Molde navidad	87
Molde nido	325

Molde osito	82, 93
Molde pan	91, 104, 105, 191
Molde pancake	81
Molde pandoro	87
Molde panettone	92, 103
Molde pastel de nata	102
Molde piruletas	82
Molde pizza	63, 64, 65, 66, 70
Molde push up	150
Molde ravioli	279
Molde rectangular	85
Molde rizado	70, 72, 73, 74, 75, 76, 79, 84, 88, 90, 94, 108
Molde savarin	71, 72, 74, 76, 79, 90, 91, 94, 102, 104
Molde semicircular	91
Molde semiesfera	98
Molde sushi	276
Molde tarta "pie"	135
Molde tortuga	113
Molde tronco	91
Molde turrón	119, 120, 121
Molde zapato	110
Molinillo	338, 339
Molinillo de café	218
Mortero	340

O

Olla	9, 10, 11, 15, 16, 18, 403, 407, 411, 412
Olla para espárragos	11
Olla para mejillones	19
Olla para pasta	16
Organizador de cajones	299
Orinal	395, 400, 405, 410

P

Paelleras	56, 57, 58, 59
Pajitas	214, 239
Palangana	395, 400, 405, 409
Pala de pescado	352
Pala para pizza	66, 176
Pala para cokies	356
Pala servir tartas	352
Paleta	163, 164, 165, 352, 357
Palillos	349
Palos para piruletas	82
Panera	285, 402, 413
Papel de horno	67
Parrilla	391
Pasador de frutas	302
Pasapurés	302
Pela ajos	328
Pelador de calabazas	332
Pelador de castañas	314
Pelador de espárragos	330
Pelador de judías	335
Pelador de naranjas	293
Pelamanzanas	262, 290
Pelapatatas	332, 333, 334, 334, 355
Pelatomates	333, 355
Perforador de huevos	327
Picador	264, 267, 336, 337
Picador rápido	267
Picador de ajos	328
Picador de hielos	352
Pico vertedor	283
Piedra para pizza	66
Pincel	167, 171, 172, 173, 194, 352
Pincho para caracoles	315
Pinzas	172, 173, 177, 316, 317, 318, 319, 339, 350
Pinzas para fondant	177, 196
Pinzas para horno	319
Pinza para platos	319
Pinza para tarros	326

Pisador	89, 101
Placa para descongelar	283
Plato	239, 392, 393, 394, 395, 396, 402, 404, 409, 413, 414
Plato hierro fundido	53
Plato para raciones	393, 396, 398, 400, 405, 410, 414
Pluma decoradora	12, 313
Portautensilios	298, 299
Pote	217, 391, 392, 395, 400, 403, 407, 408, 411, 414
Portatortillas	256, 277
Prensa-ajos	264, 328, 353
Prensa latas	344
Prensa patatas	355
Prensa tortillas	277
Protector de dedos	329
Protector de sartenes	52

Q

Quegador	126
----------	-----

R

Rabanera	287
Racionador de helado	124
Rallador	266, 268, 269, 352
Rallador de limones	355
Ramequin	109
Raspador de pescado	315
Rasqueta	164, 165, 166, 168
Rasqueta vitrocerámica	344
Reciclador de aceite	306
Recogemigas	295
Recogeverduras	295
Rejilla	176
Rejilla fregadero	312
Rejilla para pizza	66
Reposa tetetas	211
Reposa utensilios	329
Rociador de salsas	321
Rodillo amasar	132, 189, 348
Rodillo de repostería	136
Rodillo milrayas	189
Rodillo nivelador	189
Rodillo punteador	177
Rodillo de rombos	177
Rodillo para croissant	131
Rollo de pvc	101
Rompemarisco	319
Rosquillera	129
Ruleta cortapasta	135, 354
Rustideras	62, 63, 64, 65, 71, 107, 108, 406, 409

S

Sacacorchos	366, 367, 368, 373
Sacapuntas	261, 333
Saco de legumbres	322
Saco para jamón	323
Salero-pimentero	247, 310, 311
Salero de cocina	246
Salsera	247, 289
Salvamantel	312, 341
Sartén	24, 25, 26, 27, 28, 29, 31, 33, 34, 35, 36, 38, 39, 40, 41, 42, 44, 45, 46, 47, 49, 50, 51, 95, 405, 413
Sartén honda	47, 33, 34, 36, 39, 41, 43, 51
Sartén blinis	47
Sartén de crepes	26, 31, 32, 37, 40, 42, 46
Sartén pescado	46
Sartén para castañas	48
Sartén tortillas	29, 32, 35, 37, 40, 44, 47
Sartén tamagoyaki	43
Secador de pasta fresca	280
Sellos	150, 196

Separador de grasas	284
Separador de yemas	175
Servilletero	312
Sifón de natas	127
Sifón de soda	382
Sopletes	125, 126
Soporte para huevo	271
Soporte para plato hierro	53
Soporte para tacos	277
Soporte quemador	126
Soporte giratorio	177
Soporte de mangas	158
Soporte para cuchillos	258, 259, 272
Soporte para cupcake	181, 182
Soporte utensilios	360
Spray desmoldeante	67

T

Tabla	243, 244, 345
Tabla para gnocci	281
Tablillas niveladoras	189
Tamizador	169
Tapa	282, 295, 296, 297
Tapa de cristal con base	286
Tapa microondas	282
Tapas para flanero	96
Tapalimentos	301
Taper	245, 248, 249, 250, 251, 252, 253, 254, 256, 312
Tapete medidas	188
Tapete horno	78, 81
Tapones	369, 370, 371, 374, 375, 383
Tapones bomba de vacío	369
Tarro	247, 365
Tarro para ajos	247
Taza+plátano	211, 402, 408, 413
Taza de té	217
Tela	323
Temporizador	283
Tenacillas	315, 316
Tenedor	239, 352, 359, 360
Termometro	118, 303, 304, 372
Termos	231, 232, 233, 234, 235
Tetera	205, 206, 207, 208, 209, 210, 212, 213, 400, 401, 405
Tijeras	269, 270, 271
Tortillero	277
Tostador de pan	52

U

Utensilio para chocolatinas	115
-----------------------------	-----

V

Vaciador	186, 290, 355
Vaporera	48, 273, 274
Vaso	392
Vaso termo	229, 230, 231
Vaso medidas	96, 108, 170, 403
Vaso de té	216, 217
Vasos para helado	122
Velas aniversario	161, 162
Vinagreras	247, 248, 309, 310

W

Wok	28, 29, 32, 36, 37, 45, 46, 48
-----	--------------------------------

Alphabetical index



A

Adapter for torch	125
Adjustable pastry mould	98
Adjustable rolling pin	189
Airpot	235, 373
Angel food mould	102
Anodized mould	190, 191
Anti-drip neck	372
Appetizer dish	287
Apple corer	290, 354
Apple peeler	262, 290
Apple slicer	290
Asparagus pot	11
Asparagus peeler	330
Aspic mould	93
Avocado slicer	291

B

Bag for plant milk	323
Bag for vegetables	341
Bags for grill	321
Baguette pan	89, 97
Baking cups	178, 179, 180, 181, 185, 186
Baking sheet	62, 63, 64, 65, 71, 84, 91, 107, 108
Baking sheet	78, 81
Balling spoon	313
Balls for desserts	186
Banneton	106
Base	191
Beans slicer	335
Bin for recycling	342
Bird's nest mould	325
Birthday candles	161, 162
Biscuit stamp	150
Blinis pan	47
Boiled egg cup	271
Bottle	220, 221, 222, 223, 224, 224, 225, 226, 227, 228, 363, 364
Bottle cleaning brush	235
Bottle cooler	373, 376, 377
Bottle opener	354, 384
Bottle pourers	369, 370, 371, 374, 375, 383
Bowl	108, 117, 160, 241, 242, 288, 396, 399, 402, 403, 404, 409, 410, 412, 414
Bowl semi-round	117
Box for sweets	119, 120, 184, 185, 215
Bread bag	285
Bread basket	286
Bread box	285, 402, 413
Bread marking knife	106
Bread stamp	150
Bread toaster	52
Brush	167, 171, 172, 173, 194, 352
Bûche mould	98, 113
Bucket	325, 377, 378, 395, 396, 401, 406, 407, 411, 414
Bundt pan	90
Burner	126
Butter dish	247, 406, 413
Butter knife spreader	354

C

Cake leveler	187
Cake mould	70, 72, 73, 74, 76, 77, 78, 79, 80, 84, 85, 88, 91, 94, 97, 103, 104, 105, 107, 191
Cake pops mould	82
Cake server	352

Cake slicer	186, 187
Cake tester	164
Can cooler	376
Can crusher	344
Candy cases	180, 181, 185, 186
Canning jar lifter	326
Casserole	6, 7, 8, 9, 10, 11, 13, 14, 15, 16, 18, 411
Cast iron plate	53
Cast iron plate	53
Chamber pot	395, 400, 405, 410
Champagne bottle opener	368
Champagne cooler	377, 378
Charger plate	289
Chebakia cutter	121
Cheese knife	293, 352
Cheese shaker	311
Cheese slicer	294, 295, 355
Cherry stoner	266, 292, 328
Chesnut pan	48
Chesse cutter	294, 295
Chestnut peeler	314
Chicken roast stand	321
Chocolate pan	112, 113, 114, 115
Choper/scrapper	295
Chopper	264, 267, 336, 337
Chopper quick	267
Chopsticks	349
Christmas pan	87
Cleaning brush for pots	343, 344
Clip	339
Clip for dishes	319
Cloth	323
Cocktail shaker	378
Cocktail spoon	378
Cocktail strainer	383
Cocotte	14, 17, 403
Coffee capsule filler	218
Coffee grinder	218
Colander	215, 287, 300, 301, 412
Cold accumulator	391
Cold meat kit	275
Condiments dispenser	254, 309, 310
Cone for jams	326
Conical coffee maker	396, 400, 401, 405, 410
Cookbook stand	315
Cookie cutters	135, 137, 139, 140, 141, 142, 143, 144, 145, 146, 146, 147, 148, 149
Cookie gun	128, 129
Cooking ball	320
Cooking mat	66
Cookware sets	13
Corkscrew	366, 367, 368, 373
Couplers	155
Cover for microwave	282
Cream caramel mould	72, 73, 74, 75, 76, 78, 79, 80, 83, 86, 90, 91, 96, 102, 108, 405
Cream custard mould	102
Cream jug	401
Cream puffs kit	132
Cream roll mould	92, 97, 103
Crepe pan	26, 31, 32, 37, 40, 42, 46
Crepe spatule	132, 348, 356
Crimpers for fondant	177, 196
Croissant cutter roller	131
Croquette machine	134
Croquettes kit	134
Crostata cutter	176
Crumbs cleaner	295
Cupcake mould	186
Cupcake support	181, 182
Cupcake wrapper	182

Cutlery 254, 259, 260, 392
 Cutlery strainer 298
 Cuttin board 243, 244, 345
 Cylindrical pot 12, 16, 205

D

Decanter cleaning balls 372
 Decorating pen 158
 Decorating tools 261, 336
 Decorating tubes 151, 152, 153, 154, 155, 156, 157
 Dicer 261, 262, 264
 Diffuser for gas 21
 Dish 239, 392, 393, 394, 395, 396, 402, 404, 409, 413, 414
 Dish drainer 305
 Dish drainer mat 305
 Dispenser for coffee capsules 219
 Dispenser for water 343
 Doilies 183, 184
 Donut maker 129
 Double boiler 117
 Dough cutter 138
 Doughnut mold 78, 86
 Drawer organizer 299
 Dumpling maker 133

E

Easter egg mould 92
 Eco
 Egg basket 300
 Egg holder 300
 Egg mould 93, 110, 113, 133
 Egg piercer 327
 Egg poacher 92, 274
 Egg slicer 326
 Egg splitter 132
 Emery sponge 343
 "Empanada" pan 97
 Espresso coffee maker 200, 201, 202, 203

F

Falafel mould 276
 Fat eraser 284
 Filters 211, 215, 216, 320
 Finger shield 329
 Fish fry pan 46
 Fish scaler 315
 Fish server 352
 Flan cup lids 96
 Flour bin mesh 301
 Fluted mould 94
 Foie-gras cutter 295
 Foil cutter 369
 Fondant 188
 Fondant icing level 189
 Fondue 115
 Food containers 245, 248, 249, 250, 251, 252, 253, 254, 256, 312
 Food cover 301
 Food mill 302
 Food saber 255, 385, 386
 Fork 239, 352, 359, 360
 Fritter ladle 130, 131
 Fruit baller 186, 290, 355
 Fruit bowl 402, 413
 Fruit perserver 238
 Fruit squeezer 289, 314, 378

Fry pan 24, 25, 26, 27, 28, 29, 31, 33, 34, 35, 36, 38, 39, 40, 41, 42, 44, 45, 46, 47, 49, 50, 51, 95, 405, 413
 Fry pan deep 47, 33, 34, 36, 39, 41, 43, 51
 Frying basket 52, 325
 Frying set 12
 Frying set 72, 36, 39, 42, 46, 51
 Funnel 326, 342, 413

G

Garlic chopper 328
 Garlic jar 247
 Garlic peeler 328
 Garlic press 264, 328, 353
 Garlic slicer 263
 Gas 125, 126
 Ginger mould 111
 Girolle scraper 116
 Glass cover with base 286
 Glass markers 372, 383
 Gnocci board 281
 Goggles 330
 Grater 266, 268, 269, 352
 Gravy boat 247, 289
 Grease/oil separator 284
 Grill 26, 30, 32, 33, 34, 35, 36, 37, 39, 42, 45
 Grill gaz 48
 Grinder 338, 339
 Gummy bear mold 81, 111

H

Half round loaf pan 91
 Half sphere mould 98
 Halloween 86
 Ham bag 323
 Ham stand 350
 Hamburguer maker 324
 Handbag mould 111
 Handles 8, 29, 57
 Heart shape mould 85, 92, 94, 109, 111
 Herb box 338
 Holders for dish rag 341
 Honey dispenser 311, 346

I

Ice balls 379, 380
 Ice bucket 378
 Ice cream glasses 122
 Ice cream moulds 122, 123
 Ice cream scoop 124, 354
 Ice cream scoop 124
 Ice crusher 352
 Ice moulds 379, 380
 Ice shovel 294
 Icing gadgets 156, 157, 158, 215
 Induction-vitroc ceramic adapter 20, 203
 Infuser 215, 216
 Isothermal bag 387, 388, 389, 390

J

Jar 247, 365
 Jar opener 304, 305, 334, 354
 Jelly moulds 186
 Jeweler mould 109

K

Kettle descaler	214
Kettles	212, 213, 401
Kitchen grater	263
Kitchen scale	161
Kitchen string	322
Kitchen tools holder	298, 299
Knife	239, 257, 258, 259, 272, 273
Knife-fondant	196

L

Ladle	351, 353, 354, 356, 357, 358, 359, 360, 36, 362, 396, 404, 410, 415
Larding needle	355
Lattice cutting roller	177
Lemon cutter	262
Lemon grater	355
Leveling rings	189
Lid	282, 295, 296, 297
Lighters	344
Liqueur measurer	381
Liquid-detergent dispenser	343
Loaf pan	91, 104, 105, 191
Lollipop sticks	82
Low tart mould	74
Lunch away	253
Lunch box	254

M

Magnifying glass for refrigerator	284
Mango pitter	292
Mate set	214
Measuring cup	96, 108, 170, 403
Measuring cups	168
Measuring jar	169
Measuring spoons	168
Meat netting	322
Meat tenderizer	327
Meat tenderizer	347, 354
Melon-pineapple slicer	291
Milk chum	287, 395, 406, 412
Modeling tool	189
Mortar	340
3d mould	109, 110, 194, 195
Mould for letters	188
Mould for lollipops	82
Moulds mini	86, 94
Moule chocolate	109, 114, 115, 116
Mudler	379
Muffin pan	80, 83
Muffin pan	71, 76, 80, 84, 89, 90
Mug	217, 391, 392, 395, 400, 403, 407, 408, 411, 414
Mug + platillo	211, 402, 408, 413
Multi roll dispenser	304
Mussel stockpot	19

N

Napking holder	312
Net bag for legumes	322
Nougat mould	119, 120, 121
Nutcracker	314

O

Oblong pan	85
Oignon holder	329
Oil can	248, 307, 308, 309
Oil recycler	306

Oil strainer	306
Olive ladle	358, 410
Olivier salad cutter	265
Omelette holder	256, 277
Omelette pan	29, 32, 35, 37, 40, 44, 47
Opener	374
Orange peeler	293
Oval platter	183, 184, 287, 289, 393, 394, 396, 404, 409, 414
Oven glove	341
Oven proof paper	67
Oven tongs	319
Oyster opener	334, 35

P

Paella pans	56, 57, 58, 59
Pan protector	52
Pancke mould	81
Pandoro mould	87
Panettone mould	92, 103
Pasta cutter	135, 354
Pasta drying rack	280
Pasta machine	280
Pasta pot	16
Pastry bag holder	158
Pastry bags	156, 157, 158, 159, 160
Pastry mat	188
Pastry plastic ribbon	101
Pepper corer	292
Pestle	340
Petit choc kit	149
Pie mini mould	135
Pie mould	70, 72, 74, 76, 79, 84, 92, 104, 108, 190
Pineapple slicer	291
Pitcher	204, 205, 287, 289, 364, 395, 400, 405, 406, 409, 412
Pizza cutter	334, 335, 354
Pizza mould	63, 64, 65, 66, 70
Pizza screen	66
Pizza stone	66
Plate for defrosting	283
Platter	406, 408
Plunger coffee maker	204
Pomegranate deseeder	290
Portion maker	187, 188
Potato masher	355
Potato peeler	332, 333, 334, 334, 355
Pourer	371, 374
Power bar kit	275
Presentation spoons	313
Pumpkin decorating utensils	327, 332
Pumpkin mold	83, 86
Pumpkin peeler	332
Push up cake mold	150
Pusser	89, 101

R

Rack	176
Ramekin	109
Ravioli attachment	280
Ravioli cutter	278, 278
Ravioli mould	279
Revolving cake stand	177
Rings	99, 100, 101
Roast pans	62, 63, 64, 65, 71, 107, 108, 406, 409
Roasting bags	321
Roasting casserole	21
Roller docker	177
Rolling pin	132, 189, 348
Rolling pin cover	323
Rolling pin fondant	136
Roscots cutter	129
Rosette mould	130
Round dish	13, 17, 393

S

Salad sets	247, 248, 309, 310
Salad spinner	337
Salt & pepper set	247, 310, 311
Salt cellar	246
Sauce baster	321
Sauce bowl	399
Sauce syringe	321
Saucepan 8, 19, 10, 11, 12, 13, 15, 16, 17, 18, 396, 403, 407, 409	
Savarin mould	71, 72, 74, 76, 79, 90, 91, 94, 102, 104
Scissors	269, 270, 271
Scout canteen	392
Scraper	163, 165
Scraper	164, 165, 166, 168
Seafood cracker	319
Server-base for pizza	66, 176
Serving plate	393, 396, 398, 400, 405, 410, 414
Serving tray	415
Shaker	169
Sharpener	330, 331
Shoe mold	110
Sieve	302
Sieve/sifter	169
Sink strainer	312
Skewers	349
Skewers for snails	315
Skimmer	283, 351, 353, 356, 357, 358, 359, 360, 361, 362, 396, 404, 410, 415
Slicer	26, 262, 267, 327, 335
Soda siphon	382
Spaghetti server	352, 353, 356, 357, 358, 359, 360, 361, 362
Spaguetti measurer	280
Spatula for cookies	356
Spatula for omellettes	356
Spatula grill	357
Spatula tamagoyaki	43
Spatula-scraper	163, 164, 165, 352, 357
Spatules	163, 164, 165, 166, 167, 168, 171, 351, 352, 353, 356, 357, 358, 359, 360, 361, 362
Sphere mould	110
Sponge cake pan	92
Spoon	171, 172, 173, 240, 351, 353, 356, 357, 358, 359, 360, 361, 362, 396, 404, 410, 415
Spoon pen	12, 313
Spout	283
Spray (mould greasing)	67
Springform	70, 72, 91, 75, 77, 85, 88, 91, 94, 96, 103, 191
Springform with glass base	77
Square mould	70, 85, 91, 107, 190
Squeeze bottle	160
Stamps	150, 196
Stand	416
Steam basket	11, 21, 320
Steam case	273, 274
Steam casserole	11
Steamer	48, 273, 274
Stewing bag	320
Stock pot	9, 10, 11, 15, 16, 18, 403, 407, 411, 412
Stone grill	281
Stoppers for vacuum pump	369
Strainer	287, 396, 404, 412
Strainer for pasta/asparragus	325
Straws	214, 239
Stripes roller	189
Sugar bowl	311, 401, 414
Support	126
Support for knives	258, 259, 272
Sushi maker	276

T

Table bin	312
Tablemat	312, 341

Taco holder	277
Tamagoyaki pan	43
Tart mould	70, 72, 73, 74, 75, 76, 79, 84, 88, 90, 94, 108
Tea balls	216
Tea cup	217
Tea glass	216, 217
Tea pot	205, 206, 207, 208, 209, 210, 212, 213, 400, 401, 405
Teapot trivet	211
Teapot warmer	212
Teddy bear pan	82, 93
Termo airpot	234
Thermocan	230
Thermometer	118, 303, 304, 372
Thermos	231, 232, 233, 234, 235
Timer	283
Tin opener	261, 334, 353, 383, 384
Tomato corer	355
Tomato peeler	333, 355
Tongs	172, 173, 177, 316, 317, 318, 319, 339, 350
Tongs	315, 316
Tool stand with spoon	329
Tools stand	360
Topsy-turvy cake pan	87
Torches	125, 126
Tortilla warmerl	277
Tortilla press	277
Tortoise mold	113
Truffle shaver	293
Trunk mold	91
Trussing needle	313
Tube cleaning brush	155
Tumbler	392
Turkish coffee pot	401

U

Utensils for chocolate candy	115
------------------------------	-----

V

Vacuum mug	229, 230, 231
Vacuum sine saber	369
Vegetable saver	345
Vegetable sharpener	261, 333
Vegetables brush	329
Vitroceramic scraper	344

W

Waffle maker	132
Wall rack	360, 406, 412, 415
Wash bowl	395, 400, 405, 409
Watermelon corer&server	292
Whipper's charges (cream)	127
Whipper's charges (soda)	382
Whipper's cleaning sponge	235
Whippers	127
Whisk	171, 173, 174, 214, 353
Whistling kettle	213
Wine areator	372
Wine set	373
Wine tags	374
Wire grill	391
Wok	28, 29, 32, 36, 37, 45, 46, 48
Wood	346

Y

Yolk separator	175
----------------	-----

Table d'es matières



A

Accesoire à ravioli	280
Accumulateur de froid	391
Adaptateur de chalumeau	125
Adaptateur induction- vitroc�ramique	20, 203
Adaptateurs	155
Aerateur de vin	372
Aiguille � brider	313
Aiguille � larder	355
Aiguiseur	330, 331
Airpot	235, 373
Allume gaz	344
Anneau anti-goutte	372
Anneaux per livellare	189
Anti-calcaire pour th�ieres	214
Appareil pour tortillas	277
Assiette	239, 392, 393, 394, 395, 396, 402, 404, 409, 413, 414
Attendrisseur � viande	327
Attendrisseur � viande	347, 354

B

Baguettes	349
Bain marie	117
Balance de cuisine	161
Banneton	106
Barquettes � p�tisserie	178, 179, 180, 181, 185, 186
Base	191
B�tons pour sucettes	82
Batteries	13
Bec verseur	371, 374
Bec verseur	283
Beurrier avec couvercle	247, 406, 413
Bidon � lait	287, 395, 406, 412
Billes pour d�canteur	372
Billes pour p�tisserie	186
Bois	346
Bo�te	119, 120, 184, 185, 215
Bo�te � �pices	338
Bo�te � oeufs	300
Bo�te � pain	285, 402, 413
Bo�te � saupoudrer	169
Bo�te � tortilla	256, 277
Bo�te alimentaire	245, 248, 249, 250, 251, 252, 253, 254, 256, 312
Bo�te alimentaire	254
Bo�te alimentaire	245, 248, 249, 250, 251, 252, 253, 254, 256, 312
Bouchons pour pompe � vide	369
Bouchons verseurs	369, 370, 371, 374, 375, 383
Bougies d'anniversaire	161, 162
Bouilloire sifflante	213
Bouilloires	212, 213, 401
Boule � glaces	124
Boule pour pot-�-feu	320
Boules � th�	216
Boules de glaces	379, 380
Bouteille	220, 221, 222, 223, 224, 224, 225, 226, 227, 228, 363, 364
Bouteille isotherme	231, 232, 233, 234, 235
Brochettes	349
Brosse � bouteilles	235
Brosse � douille	155
Brosse � laver l�gumes	329
Brosse pour nettoyer les casseroles	343, 344
Br�leur	126

C

Cafeti�re conique	396, 400, 401, 405, 410
Cafeti�re embolo	204
Cafeti�re espresso	200, 201, 202, 203
Cafeti�re turcque	401
Canette isotherme	230
Casse-noix	314
Casserole 8, 19, 10, 11, 12, 13, 15, 16, 17, 18, 396, 403, 407, 409	16
Casserole pour p�tes	168
Casseroles � mesurer	99, 100, 101
Cercles	125, 126
Chalumeaux	127
Charges pour siphon (cr�me)	382
Charges pour siphon (soda)	212
Chauffe-th�ieres	277
Chauffe-tortillas	269, 270, 271
Ciseaux	339
Clip	301
Cloche alimentaire	14, 17, 403
Cocotte	373
Coffret � vin	273, 274
Coffret vapeur	344
Compacteur de bo�tes	238
Conservateur de fruits	345
Conservation de l�gumes	255, 385, 386
Contenant alimentaire	271
Coquetier	402, 413
Coupe � fruits	369
Coupe capsules	314
Coupe ch�staignes	294, 295
Coupe fromage	261, 262, 264
Coupe pommes de terre	265
Coupe salade russe	295
Coupe-foie-gras	294, 295, 355
Coupe-fromages	326
Coupe-oeuf	135, 137, 139, 140, 141, 142, 143, 144, 145, 146, 146, 147, 148, 149
Coupe-p�te	278, 278
Coupe-p�te ravioli	293
Coupe-truffes	26, 262, 267, 327, 335
Coupeur de l�gumes	292
Coupeur-serveur � past�que	239, 257, 258, 259, 272, 273
Couteau	293, 352
Couteau � fromage	334, 35
Couteau � h�tres	196
Couteau pour fondant	354
Couteau-spatuyle pour le beurre	282, 295, 296, 297
Couvercle	286
Couvercle en verre avec fond	282
Couvercle per microonde	96
Couvercle pour moule � flan	254, 259, 260, 392
Couverts	186
Cpasules pour dupcake	158
Crayon � d�corer	401
Cr�mi�re	171, 172, 173, 240, 351, 353, 356, 357, 358, 359, 360, 361, 362, 396, 404, 410, 415
Cuill�re	378
Cuill�re � cocktail	124, 354
Cuill�re � glace	168
Cuill�re � mesurer	352, 353, 356, 357, 358, 359, 360, 361, 362
Cuill�re � spaghetti	12, 313
Cuill�re plume	313
Cuill�re sph�rifications	313
Cuill�res de pr�sentation	325
Cuiseur pour p�tes et asperges	48, 273, 274
Cuiseur vapeur	11
Cuit-asperges	395, 400, 405, 409
Cuvette	

D

Décapsuler	374
Décapsuleur	354, 384
Decò légumes	261, 336
Décorateurs	156, 157, 158, 215
Découpoir à beignets	129
Découpoirs	138
Dénoyateur à mangue	292
Dénoyateur à cerises	266, 292, 328
Dessous assiette	289
Dessous de plat	312, 341
Diffuseur pour gazinières	21
Distributeur de capsules	219
Distributeur de d'eau	343
Distributeur de détergent liquide	343
Distributeur film/papier	304
Distributeurs de condiments	254, 309, 310
Doseur à miel	311, 346
Doseur de liqueur	381
Douilles	151, 152, 153, 154, 155, 156, 157

E

Écailleur à poisson	315
Eco	
Ecumoire	283, 351, 353, 356, 357, 358, 359, 360, 361, 362, 396, 404, 410, 415
Effileur pour haricots	335
Égouttoir à assiettes	305
Égouttoir à couverts	298
Égreneuse à grenades	290
Éliminateur de graisse	284
Emballage de cupcakes	182
Emporte-pièce de chebakia	121
Ensemble à maté	214
Entonnoir	326, 342, 413
Entonnoir pour confitures	326
Épluche-ail	328
Épluche-ananas	291
Eplucheur à aspergus	330
Eplucheur à citrouilles	332
Éplucheur à légumes	332, 333, 334, 334, 355
Éplucheur à tomate	333, 355
Éplucheur d'oranges	293
Eplucheur de pommes	262, 290
Éponge en émeri	343
Éponge nettoyant	235
Essoreuse à salade	337
Étiquettes pour vin	374
Évideur à poivrons	292

F

Faitout	6, 7, 8, 9, 10, 11, 13, 14, 15, 16, 18, 411
Faitout cuit vapeur	11
Faitout four	21
Feuille de cuisson	66
Fil de cuisine	322
Filet élastique	322
Filtres	211, 215, 216, 320
Flacon verseur souple	160
Fondant	188
Fondue	115
Fouet	171, 173, 174, 214, 353
Fourchette	239, 352, 359, 360

Frill pierre	281
Friteuse avec panier	12
Friteuse avec panier	12, 36, 39, 42, 46, 51

G

Gant	341
Gaz	125, 126
Gide coupe-gâteau	186, 187
Girolle à fromage	116
Gobelet	217, 391, 392, 395, 400, 403, 407, 408, 411, 414
Gobelet + assiette	211, 402, 408, 413
Gourde	392
Grill	26, 30, 32, 33, 34, 35, 36, 37, 39, 42, 45
Grill	391
Grill gaz	48
Grille	176
Grille pain	52
Grille pour évier	312
Grille pour pizza	66

H

Hachoir	264, 267, 336, 337
Hachoir de l'ail	328
Hachoir rapide	267
Halloween	86
Huillier	248, 307, 308, 309
Identificateurs de verres	372, 383
Infuseur	215, 216
Kit à barres énergétiques	275
Kit à charcuterie	275
Kit à petit chou	132
Kit petit choc	149
Kit pour croquettes	134

L

Lame pour entailler le pain	106
Lamineur ail	263
Louche	351, 353, 354, 356, 357, 358, 359, 360, 36, 362, 396, 404, 410, 415
Louche à beignets	130, 131
Louche à olives	358, 410
Loupe pour réfrigérateur	284
Lunch away	253
Lunettes	330
Lyre à génoise	187

M

Machine à churros	128, 129
Machine à croquettes	134
Machine à donuts	129
Machine à pâte	280
Machine de capsules café	218
Mandoline	263
Marmite	9, 10, 11, 15, 16, 18, 403, 407, 411, 412
Marmite à moules	19
Marqueur	150, 196
Marqueur à gateaux	187, 188
Marqueur pour biscuits	150
Marqueur pour pains	150
Mesure à spaghetti	280
Minuterie	283

Mortier 340
 Moule à glace 122, 123
 Moule pour tarta "pie" 135
 Moule "pastel de nata" 102
 Moule 3d 109, 110, 194, 195
 Moule à aspic 93
 Moule à boules 186, 290, 355
 Moule à bûche 98, 113
 Moule à cake 70, 72, 73, 74, 76, 77, 78, 79, 80, 84, 85, 88, 91, 94, 97, 103, 104, 105, 107, 191
 Moule à chaussons 133
 Moule à cigarette 92, 97, 103
 Moule à crème caramel 72, 73, 74, 75, 76, 78, 79, 80, 83, 86, 90, 91, 96, 102, 108, 405
 Moule à falafel 276
 Moule à gaufre 132
 Moule à madelaine 92
 Moule à oeuf 93, 110, 113, 133
 Moule à pain 91, 104, 105, 191
 Moule à panettone 92, 103
 Moule à pizza 63, 64, 65, 66, 70
 Moule à rosace 130
 Moule à savarin 71, 72, 74, 76, 79, 90, 91, 94, 102, 104
 Moule à steak haché 324
 Moule à sushi 276
 Moule à tarte dentelé 70, 72, 73, 74, 75, 76, 79, 84, 88, 90, 94, 108
 Moule angel food 102
 Moule anodizado 190, 191
 Moule bas 74
 Moule boîte coeur 109
 Moule bonbons 112, 113, 114, 115
 Moule cannelé 94
 Moule carré 70, 85, 91, 107, 190
 Moule chaussure 110
 Moule chocolat 109, 114, 115, 116
 Moule citrouille 83, 86
 Moule confiseries 81, 111
 Moule demi-lune 91
 Moule démontable 70, 72, 91, 75, 77, 85, 88, 91, 94, 96, 103, 191
 Moule démontable avec base en verre 77
 Moule doughnut 78, 86
 Moule en forme de lettres 188
 Moule extensible 98
 Moule forme coeur 85, 92, 94, 109, 111
 Moule forme petit ours 82, 93
 Moule ginger 111
 Moule haut 70, 72, 74, 76, 79, 84, 92, 104, 108, 190
 Moule kouglof 90
 Moule oeuf de pâques 92
 Moule pandoro 87
 Moule pour cake pops 82
 Moule pour pancakes 81
 Moule pour sucettes 82
 Moule push up cake 150
 Moule raviolis 279
 Moule rectangulaire 85
 Moule rond incliné 87
 Moule sac 111
 Moule semiesphère 98
 Moule sphère 110
 Moule tortue 113
 Moule touron 119, 120, 121
 Moule tronc 91
 Moules à gelée 186
 Moules glaçons 379, 380
 Moules mini 86, 94
 Moules pralinés 180, 181, 185, 186
 Moulin pour café 218
 Moulin râpe 338, 339
 Mug isotherme 229, 230, 231

N

Napperons 183, 184

O

Organisateur de tiroir 299
 Outils pour fondant 189
 Ouvre-bocaux 304, 305, 334, 354
 Ouvre-boîtes 261, 334, 353, 383, 384

P

Pailles 214, 239
 Panier à nid 325
 Panier à oeufs 300
 Panier pour le pain 286
 Panier vapeur 11, 21, 320
 Paniers 52, 325
 Papier cuisson 67
 Passoir à coulis 302
 Passoire 215, 287, 300, 301, 412
 Passoire 287, 396, 404, 412
 Passoire à oeuf 132
 Passoire cocktail 383
 Pelle à farine 294
 Pelle à pizza 66, 176
 Pelle à poisson 352
 Pelle à tarte 352
 Pelle pour cookies 356
 Penderie murale 360, 406, 412, 415
 Perceur d'oeufs 327
 Picher séparateur de graisse 284
 Pierre pour pizza 66
 Pileur à glace 352
 Pilon à cocktails 379
 Pince 315, 316
 Pince à bocciaux 326
 Pince à fruit de mer 319
 Pince pour four 319
 Pince pour plats 319
 Pinceau 167, 171, 172, 173, 194, 352
 Pincés 172, 173, 177, 316, 317, 318, 319, 339, 350
 Pincés pour fondan 177, 196
 Pique découpe-oignons 329
 Piques à escargots 315
 Planche à découper 243, 244, 345
 Planche à gnocci 281
 Planches à niveler 189
 Plaque à biscuits 62, 63, 64, 65, 71, 84, 91, 107, 108
 Plaque à biscuits 71, 76, 80, 84, 89, 90
 Plaque baguette 89, 97
 Plaque découpoir crostata 176
 Plaque Noël 87
 Plaque pou décongeler 283
 Plaques cavités 80, 83
 Plat 406, 408
 Plat à "empanada" 97
 Plat à rations 393, 396, 398, 400, 405, 410, 414
 Plat en fonte de fer 53
 Plat en fonte de fer 53
 Plat oval 183, 184, 287, 289, 393, 394, 396, 404, 409, 414
 Plat rond 13, 17, 393
 Plateau de service 415
 Plateau tournant 177
 Plats à paëlla 56, 57, 58, 59
 Plats à rôtir 62, 63, 64, 65, 71, 107, 108, 406, 409
 Poches à décorer 156, 157, 158, 159, 160
 Pocheuse à oeuf 92, 274
 Poêle 24, 25, 26, 27, 28, 29, 31, 33, 34, 35, 36, 38, 39, 40, 41, 42, 44, 45, 46, 47, 49, 50, 51, 95, 405, 413
 Poêle à blinis 47
 Poêle à crêpes 26, 31, 32, 37, 40, 42, 46

Poêle à marrons	48
Poêle à omelette	29, 32, 35, 37, 40, 44, 47
Poêle à poisson	46
Poêle à tamagoyaki	43
Poêle profonde	47, 33, 34, 36, 39, 41, 43, 51
Poignées	8, 29, 57
Poire à sauce	321
Poivrière-salière	247, 310, 311
Pompe à vide	369
Porte ustensiles de cuisine	298, 299
Porte-serviettes	312
Porte-torchons	341
Pot	247, 365
Pot à eau	204, 205, 287, 289, 364, 395, 400, 405, 406, 409, 412
Pot à huile	306
Pot cylindrique	12, 16, 205
Pot de chambre	395, 400, 405, 410
Pot pour l'ail	247
Poubelle de table	312
Poubelle pour séletif	342
Poussoir	340
Poussoir	89, 101
Presentoir	416
Presse purée	302
Presse purée	355
Presse-ail	264, 328, 353
Presse-fruits	289, 314, 378
Protecteur de doigts	329
Protection pour poêles	52
Pupitre	315

R

Raclette	164, 165, 166, 168
Racloir vitroceramique	344
Ramasse miettes	295
Ramequin	109
Ramsasse légumes/herbes	295
Râpe	266, 268, 269, 352
Râpe a citron	355
Ravier	287
Recipient demi-sphérique	117
Récepteur pour sauces	399
Recycleur d'huile	306
Refrâchisseur à bouteilles	373, 376, 377
Refrigerateur de canettes	376
Repose ustensiles	329
Rôtissoire à poulet	321
Rouleau à losange	177
Rouleau à pâtisserie	132, 189, 348
Rouleau ajustable	189
Rouleau coupeur de croissant	131
Rouleau fondant	136
Rouleau milleraies	189
Rouleau picke vite	177
Roulette à pizza	334, 335, 354
Roulette coupe-pâtes	135, 354
Ruban pvc pâtissier	101

S

Sac à jambon	323
Sac à légumes	341
Sac à légumes	322
Sac à pain	285
Sac isotherme	387, 388, 389, 390
Sac pour lait végétal	323
Sac pour pot-au-feu	320
Sachets grill	321
Sacs de cuisson	321
Saladier	108, 117, 160, 241, 242, 288, 396, 399, 402, 403, 404, 409, 410, 412, 414
Salière	246

Saucière	247, 289
Saupoudreuse à fromage	311
Seau	325, 377, 378, 395, 396, 401, 406, 407, 411, 414
Seau à champagne	377, 378
Seau à glace	378
Séchoir à pâtes	280
Sectionneur à citrons	262
Sectionneur à pommes	290
Séparateur à oeuf	175
Seringue à sauce	321
Serre-jambon	350
Sectionneur à melon-ananas	291
Shaker	378
Siphon à soda	382
Siphons	127
Souvre-rouleaux	323
Spatule	163, 164, 165, 166, 167, 168, 171, 351, 352, 353, 356, 357, 358, 359, 360, 361, 362
Spatule à pâtisserie	163, 165
Spatule à crêpes	132, 348, 356
Spatule plancha	357
Spatule pour omelettes	356
Spatule tamagoyaki	43
Spatule-racloir	163, 164, 165, 352, 357
Spray démoulant	67
Sucrier	311, 401, 414
Support	126
Support pied	360
Support pour couteaux	258, 259, 272
Support pour cupcake	181, 182
Support pour poche à decorer	158
Support pour tacos	277
Support pour théière	211

T

Taille-pointe pour légumes	261, 333
Tamis	169
Tamis à farine à glissière	301
Tapis à pâtisserie	188
Tapis égouttoir	305
Tapis four	78, 81
Tasse à té	217
Termo airpot	234
Testeur de cuisson	164
Théière	205, 206, 207, 208, 209, 210, 212, 213, 400, 401, 405
Thermomètre	118, 303, 304, 372
Timbale	392
Tire-bouchon	366, 367, 368, 373
Tire-bouchon à champagne	368
Tissu	323
Tranche-avocats	291

U

Ustensils pour décorer les citrouilles	327, 332
Ustensils pour chocolaines	115

V

Verre à glaces	122
Verre à thé	216, 217
Verre mesurer	169
Verre mesurer	96, 108, 170, 403
Vide-pommes	290, 354
Vide-tomate	355
Vinaigriers	247, 248, 309, 310

W

Wok	28, 29, 32, 36, 37, 45, 46, 48
-----	--------------------------------

Índice alfabético



A

Abre-boiões	304, 305, 334, 354
Abre-latas	261, 334, 353, 383, 384
Abre-ostras	334, 35
Abridor de cápsulas	374
Abridor de champanhe	368
Accessório para ravioli	280
Açucareiro	311, 401, 414
Acumulador de frio	391
Adaptador indução-vitrocêramica	20, 203
Adaptador para maçarico	125
Adaptadores	155
Afiador	330, 331
Agulha de cozinha	313
Agulha para recheir	355
Airpot	235, 373
Almojariz	340
Almotolia	248, 307, 308, 309
Amaciador de carne	327
Amasador de batata	355
Anel anti-gota	372
Anilhas niveladoras	189
Apanha-migalhas	295
Aproveitador de azeite	306
Aquecedor para bules	212
Arejador de vinho	372
Aros	99, 100, 101
Arrefecedor de latas	376
Arrefedor de garrafas	373, 376, 377
Assador de frango	321
Atril	315

B

Bacia	395, 400, 405, 409
Bacio	395, 400, 405, 410
Balança de cozinha	161
Balde	325, 377, 378, 395, 396, 401, 406, 407, 411, 414
Balde champanhe	377, 378
Balde gelo	378
Balde para reciclagem	342
Bandeja	183, 184, 287, 289, 393, 394, 396, 404, 409, 414
Bandeja	406, 408
Bandeja de serviço	415
Banho maria	117
Banneton	106
Base	191
Bastonciniper lecca-lecca	82
Batedor	171, 173, 174, 214, 353
Bico vertedor	283
Bolas para pastelaria	186
Bomba de vácuo	369
Boñas para gelo	379, 380
Boquilhas	151, 152, 153, 154, 155, 156, 157

C

Caçarola	8, 19, 10, 11, 12, 13, 15, 16, 17, 18, 396, 403, 407, 409
Caçarolas medidoras	168
Cafeteira com apito	213
Cafeteira conica	396, 400, 401, 405, 410
Cafeteira embolo	204
Cafeteira expresso	200, 201, 202, 203
Cafeteira turca	401
Caixa	255, 385, 386
Caixa	119, 120, 184, 185, 215
Caixa para ovos	300

Caixa para pão	285, 402, 413
Caixa para residuos	312
Caneca	217, 391, 392, 395, 400, 403, 407, 408, 411, 414
Caneca a vácuo	229, 230, 231
Caneca com ptrato	211, 402, 408, 413
Cantil	392
Capa para rolo de amasar	323
Cápsula bomboneira	180, 181, 185, 186
Cápsula madalena	178, 179, 180, 181, 185, 186
Cápsulas para cupcake	186
Cargas para sifãos (natas)	127
Cargas para sifãos (soda)	382
Centrifuga para salada	337
Cepillo para verduras	329
Cesta para pão	286
Cesto para ovos	300
Cesto vapor	11, 21, 320
Cestos de fritadeira	52, 325
Chaleira	212, 213, 401
Chaleira	205, 206, 207, 208, 209, 210, 212, 213, 400, 401, 405
Chávana de chá	217
Clipe	339
Coador	302
Coador cocktail	383
Coador fio de ovos	132
Cocotte	14, 17, 403
Colher	171, 172, 173, 240, 351, 353, 356, 357, 358, 359, 360, 361, 362, 396, 404, 410, 415
Colher caneta	12, 313
Colher cocktail	378
Colher de gelado	124, 354
Colher de gelado	124
Colher medidora	168
Colher para azeitonas	358, 410
Colher para esferificações	313
Colher para esparguette	352, 353, 356, 357, 358, 359, 360, 361, 362
Colher para sonhos	130, 131
Colheres para apresentação	313
Concha	351, 353, 354, 356, 357, 358, 359, 360, 36, 362, 396, 404, 410, 415
Conjunto para mate	214
Conservador de frutas	238
Copo	392
Copo de chá	216, 217
Copo medidor	169
Copo medidor	96, 108, 170, 403
Copos de helado	122
Corredor	294
Corta massas	138
Corta massas	135, 354
Corta-massas	135, 137, 139, 140, 141, 142, 143, 144, 145, 146, 146, 147, 148, 149
Corta-ovos	326
Cortacapsulas	369
Cortador de batatas	261, 262, 264
Cortador de bolos	187
Cortador de chebakia	121
Cortador de foie-gras	295
Cortador de limaos	262
Cortador de melancia	292
Cortador de melão	186, 290, 355
Cortador de melões-ananás	291
Cortador de queijo	294, 295
Cortador de roscas	129
Cortador de salada russa	265
Cortador de verduras	26, 262, 267, 327, 335
Cortador em aparas	116
Cortador para maçãs	290
Cortador tarta losangos	176
Cortadores de verduras	261, 336

Cortamassas ravioli	278, 278
Cortapizza	334, 335, 354
Cozedor para massa e aspargos	325

D

Decoradores	156, 157, 158, 215
Descalcificador de bules	214
Descanso de prato	312, 341
Descanso para chaleiras	211
Descapsulador	354, 384
Descaroçador	290, 354
Descaroçador ceresa	266, 292, 328
Descaroçador de ananas	291
Descaroçador de manga	292
Descaroçador para tomate	355
Descascador de abóbora	332
Descascador de alho	328
Descascador de batatas	332, 333, 334, 334, 355
Descascador de castanhas	314
Descascador de espargos	330
Descascador de feijão	335
Descascador de laranjas	293
Descascador de tomate	333, 355
Descascador de maçãs	262, 290
Difusor para gás	21
Dispensador de água	343
Dispensador de condimento	254, 309, 310
Dispensador de detergente	343
Dispensador de filme/papel	304
Distribuidor de capsulas	219
Donuteira	129

E

Eco	
Eliminatore di grasso	284
Envoltorios de cupcakes	182
Escalfador de ovos	92, 274
Escação	371, 374
Escoador de ervas	287, 396, 404, 412
Escorredor de pratos	305
Escorredor de talheres	298
Escova limpa boquilhas	155
Escova limpadora para painéis	343, 344
Escovilhão limpa garrafas	235
Escumadeira	283, 351, 353, 356, 357, 358, 359, 360, 361, 362, 396, 404, 410, 415
Esfera para cozidos	320
Esferas para decantador	372
Espátula	163, 164, 165, 166, 167, 168, 171, 351, 352, 353, 356, 357, 358, 359, 360, 361, 362
Espatula para crepes	132, 348, 356
Espatula para omeletas	356
Espátula pastelaria	163, 165
Espatula raspador	163, 164, 165, 352, 357
Espetos	349
Esponja de esmeril	343
Esponja de limpeza	235
Espremedor	289, 314, 378
Estecas	189
Estojo para cozedura	273, 274
Estremedor de alhos	264, 328, 353
Etiquetas para vinho	374
Expositor	416

F

Faca	239, 257, 258, 259, 272, 273
Faca marcadora para pão	106
Faca para fondant	196
Faca para queijo	293, 352
Faca para queijos	294, 295, 355
Faca-espátula para manteiga	354
Fervedor	12, 16, 205
Filtros	211, 215, 216, 320
Fio de cozinha	322
Folha de cozinha	66
Fondant	188
Fondue	115
Forma 3d	109, 110, 194, 195
Forma abóbora	83, 86
Forma acanalada	94
Forma angel food	102
Forma anodizada	190, 191
Forma aspic	93
Forma bolso	111
Forma bombom	112, 113, 114, 115
Forma bundt	90
Forma com letras	188
Forma coração	85, 92, 94, 109, 111
Forma de bolo alta	70, 72, 74, 76, 79, 84, 92, 104, 108, 190
Forma de bolo baixa	74
Forma de bolo inglês	70, 72, 73, 74, 76, 77, 78, 79, 80, 84, 85, 88, 91, 94, 97, 103, 104, 105, 107, 191
Forma de pão	91, 104, 105, 191
Forma de pizza	63, 64, 65, 66, 70
Forma de pudim flan	72, 73, 74, 75, 76, 78, 79, 80, 83, 86, 90, 91, 96, 102, 108, 405
Forma de rolitos	92, 97, 103
Forma de tarte canelada	70, 72, 73, 74, 75, 76, 79, 84, 88, 90, 94, 108
Forma desmontável	70, 72, 91, 75, 77, 85, 88, 91, 94, 96, 103, 191
Forma desmontável com base de vidro	77
Forma doughnut	78, 86
Forma esfera	110
Forma extensível	98
Forma ginger	111
Forma gomas	81, 111
Forma hamburguer	324
Forma madalena	92
Forma ninho	325
Forma ovo de páscoa	92
Forma pandoro	87
Forma para cake pops	82
Forma para gofres	132
Forma para rosácea	130
Forma para salgados	133
Forma pastel de nata	102
Forma push up cake	150
Forma quadrada	70, 85, 91, 107, 190
Forma rectangular	85
Forma redonda inclinada	87
Forma sapato	110
Forma savarin	71, 72, 74, 76, 79, 90, 91, 94, 102, 104
Forma semicircular	91
Forma semiesfera	98
Forma tataruga	113
Forma tronco natal	98, 113
Forma ursinho	82, 93
Formas gelatina	186
Formas mini	86, 94
Frasco para alhos	247
Fritadeira com cesto	12
Fritadeira com cesto	12, 36, 39, 42, 46, 51
Frutero	402, 413

Funil 326, 342, 413
Funil para compotas 326

G

Galheteiros 247, 248, 309, 310
Garfo 239, 352, 359, 360
Garfos para caracóis 315
Garrafa 220, 221, 222, 223, 224, 224, 225, 226, 227, 228, 363, 364
Gáz 125, 126
Grelha 391
Grelha 176
Grelhador 26, 30, 32, 33, 34, 35, 36, 37, 39, 42, 45
Grelhador pedra 281
Grill gas 48
Grilha para banca 312
Guarda legumes 345
Guia corta-pão-sw-ló 186, 187
Guia cortacebolas 329

H

Halloween 86

I

Identificadores de taças 372, 383
Infusor 215, 216
Injector de molhos 164
Injector de molhos 321
Isqueiros 344

J

Jarra de mel 311, 346
Jarra separa gordura 284
Jarro 204, 205, 287, 289, 364, 395, 400, 405, 406, 409, 412
Jogo para vinho 373

K

Kit para barras energeticas 275
Kit para bolinhos 132
Kit para croquetes 134
Kit para fiambre 275
Kit petit choc 149

L

Laminador alhos 263
Laminador de abacate 291
Laminador de trufas 293
Lancheira 254
Lancheiras 245, 248, 249, 250, 251, 252, 253, 254, 256, 312
Lancheiras 245, 248, 249, 250, 251, 252, 253, 254, 256, 312
Lápis para decorar 158
Leiteira 287, 395, 406, 412
Leiteira 401
Lunch away 253
Lupa para frigorífico 284

M

Maçaricos 125, 126
Maço amaciador para carne 347, 354
Madeira 346
Mandolina 263
Manopla 341
Manteigueira com tampa 247, 406, 413
Maquina de capsulas de café 218

Máquina de fazer massas 128, 129
Maquina de pasta 280
Maquina para croquetes 134
Marcador 150, 196
Marcador de bolachas 150
Marcador de bolos 187, 188
Marcador de pão 150
Medidor de licor 381
Medidor para esparguette 280
Moinho para café 218
Moinho ralador 338, 339
Molde caixa coração 109
Molde chocolat 109, 114, 115, 116
Molde chupa-chups 82
Molde ovo 93, 110, 113, 133
Molde para falafel 276
Molde para gelados 122, 123
Molde para gelo 379, 380
Molde para sushi 276
Molde para tarta "pie" 135
Molde ravioli 279
Molde torrão 119, 120, 121
Molde tronco 91
Moldes para panquecas 81
Molheira 247, 289

N

Naperons 183, 184

O

Olla para cozer mejillones 19
Óráculos 330
Organizador de gavetas 299

P

Pá à peixe 352
Pá para cookies 356
Pá para servir bolo 352
Pá recolhadora de verduras 295
Pá-baseie pára pizzas 66, 176
Paelheiras 56, 57, 58, 59
Palhinhas 214, 239
Panela 9, 10, 11, 15, 16, 18, 403, 407, 411, 412
Panela para espargos 11
Panela para massa 16
Panzinhos 349
Papel para forno 67
Passador 215, 287, 300, 301, 412
Passadores para chá 216
Passe vite 302
Pedra para pizza 66
Pegas 8, 29, 57
Peneira 169
Peneira para farinha 301
Perfurador de ovos 327
Pestello 340
Picador de alhos 328
Picador de gelo 352
Picador rapido 267
Picadora 264, 267, 336, 337
Pico para cocktails 379
Pinça para forno 319
Pinça para pratos 319
Pinça para tarros 326
Pinças 172, 173, 177, 316, 317, 318, 319, 339, 350
Pinças para fondan 177, 196
Pinsel 167, 171, 172, 173, 194, 352
Pizablech mit gitestruktur 66
Plaas niveladoras 189
Placa baguettes 89, 97
Placa para descongelar 283
Placa para forno 62, 63, 64, 65, 71, 84, 91, 107, 108

Polvilhador	169
Porta guardanapos	312
Porta utensílios de cozinha	298, 299
Porta-tortilhas	256, 277
Pousa utensílios	329
Pratinho	287
Prato 239, 392, 393, 394, 395, 396, 402, 404, 409, 413, 414	
Prato de ferro fundido	53
Prato de ferro fundido	53
Prato giratório	177
Prato marcador	289
Prato para rações 393, 396, 398, 400, 405, 410, 414	
Prensa	89, 101
Prensa-latas	344
Protector de dedos	329
Protector para sertãs	52
Pulverizador de molhos	321

Q

Quebra-marisco	319
Quebra-nozes	314
Queijeira	311
Queimador	126

R

Ramequim	109
Raspador 266, 268, 269, 352	
Raspador 164, 165, 166, 168	
Raspador de escamas	315
Raspador de limão	355
Raspador vitrocerâmica	344
Reciclador de óleo	306
Recipiente para ervas	338
Recipientes para molhos	160
Rede para carne	322
Reipente para tortilhas	277
Rolhas para bomba de vácuo	369
Rolhas para verter 369, 370, 371, 374, 375, 383	
Rolo de massa fondant	136
Rolo de massa 132, 189, 348	
Rolo de massa cortador grelha	177
Rolo de massa tacejador	177
Rolo mil listras	189
Rolo nivelador	189
Rolo para cortar croissants	131
Rolo pvc pastelaria	101

S

Saca-pontas para verduras 261, 333	
Saca-rolhas 366, 367, 368, 373	
Saco isotérmico 387, 388, 389, 390	
Saco para cozer	320
Saco para legumes	322
Saco para leite vegetal	323
Saco para pão	285
Saco para presunto	323
Sacos de poliéster	341
Sacos para assar	321
Sacos para grelhador	321
Sacos pasteleiro 156, 157, 158, 159, 160	
Saleiro	246
Saleiro-pimenteiro 247, 310, 311	
Secador para massa	280
Separador gema ovos	175
Sertã 24, 25, 26, 27, 28, 29, 31, 33, 34, 35, 36, 38, 39, 40, 41, 42, 44, 45, 46, 47, 49, 50, 51, 95, 405, 413	
Sertã blinis	47
Sertã de castanhas	48
Sertã de crepes 26, 31, 32, 37, 40, 42, 46	
Sertã de peixe	46
Sertã dupla 29, 32, 35, 37, 40, 44, 47	
Sertã funda 47, 33, 34, 36, 39, 41, 43, 51	

Sertã para tamagoyaki	43
Shaker para cocktail	378
Sifãos	127
Sifone soda	382
Spatula chapas	357
Spatula tamagoyaki	43
Spray antiaderente	67
Stampo panettone	92, 103
Suporte	126
Suporte de arame	360
Suporte de facas 258, 259, 272	
Suporte para cupcake 181, 182	
Suporte para ovo	271
Suporte para pendurar panos	341
Suporte para presunto	350
Suporte para tacos	277
Suporte parede 360, 406, 412, 415	
Suporte sacos pasteleiro	158

T

Tábua 243, 244, 345	
Tábua para gnocci	281
Tabuleiro "empanada"	97
Tabuleiro bolinhos 71, 76, 80, 84, 89, 90	
Tabuleiro natal	87
Tabuleiros 62, 63, 64, 65, 71, 107, 108, 406, 409	
Tabuleros bolinhos 80, 83	
Tacho 6, 7, 8, 9, 10, 11, 13, 14, 15, 16, 18, 411	
Tacho a vapor	11
Tacho baixo 13, 17, 393	
Tacho forno	21
Talheres 254, 259, 260, 392	
Tampa 282, 295, 296, 297	
Tampa de vidro com base	286
Tampa para flan	96
Tampa para microondas	282
Tapa-pratos	301
Tapete de confeitaria	188
Tapete escorredor de pratos	305
Tapete forno 78, 81	
Tarro 247, 365	
Tela	323
Temporizador	283
Tenazes 315, 316	
Termo airpot	234
Termolata	230
Termometro 118, 303, 304, 372	
Tesoura 269, 270, 271	
Thermo 231, 232, 233, 234, 235	
Tigela 108, 117, 160, 241, 242, 288, 396, 399, 402, 403, 404, 409, 410, 412, 414	
Tigela para molhos	399
Tigela semiesférica	117
Torrador de pão	52
Trems	13

U

Utensílios para cocolatinhos	115
Utensílio para limpar pimento	292
Utensílio para retirar sementes	290
Utensílio para tortilhas	277
Utensílios para decorar abóboras	327, 332

V

Vaporeira 48, 273, 274	
Velas de aniversário 161, 162	

W

Wok 28, 29, 32, 36, 37, 45, 46, 48	
------------------------------------	--

Ref.	Pag.	Ref.	Pag.	Ref.	Pag.	Ref.	Pag.	Ref.	Pag.
000008	416	250508	153	355222	74	403024	40	409523	30
000887	416	250606	152	355308	75	403026	40	409529	30
000888	416	250610	152	355422	74	403028	40	410016	42
000888B	416	250611	152	355426	74	403030	40	410018	42
000906	59	250616	152	355430	74	403032	40	410020	42
000907	228	250708	152	355432	74	403036	40	410022	42
000909	240	250711	152	355527	74	403124	41	410024	42
000934	153	250908	153	355728	74	403128	41	410026	42
000946	157	250909	153	355732	74	403132	41	410028	42
000957	13	251009	153	355824	74	403328	41	410030	42
000970	49	252000	154	355826	74	403332	41	410226	58
000970	50	252001	154	355828	74	403336	41	410230	58
000988	242	252100	155	355925	74	403340	41	410234	58
000999	416	252200	155	355930	74	404014A	49	410238	58
100600	21	252300	153	355935	74	404014B	49	410242	58
100626	21	252400	154	356016	75	404014C	49	410326	42
100628	21	260016	239	356018	75	404014D	49	410420	43
100630	21	260020	239	356020	75	404014E	49	410424	43
100632	21	260024	239	356124	64	404014F	49	410426	43
102308	392	260100	239	356128	64	404230	29	410428	43
140626	102	260101	239	356132	64	404512	47	410430	43
140628	102	260102	240	356224	75	404514	47	410432	43
140807	102	260103	240	356228	75	405014	44	410524	43
140808	102	260300	239	356232	75	405014C	44	410526	43
140809	102	260402	239	356524	75	405016	44	410528	43
142000	102	260403	239	356526	75	405018	44	410530	43
151215	287	260405	239	356528	75	405020	44	410532	43
151220	287	260410	239	356626	75	405022	44	410536	43
200730	67	300214	17	356928	64	405024	44	410540	43
200742	67	300216	17	356932	64	405026	44	410618	42
200840	67	300620	47	370210	72	405028	44	410624	42
215000	104	300624	47	370308	72	405030	44	410626	42
215001	104	300929	64	370826	72	405100	45	410700	42
215002	104	300935	64	370925	72	405218	45	410816	16
215003	104	300940	64	371426	72	405226	45	410820	16
215004	104	301140	64	371526	72	405314	17	410824	16
215005	104	321118	47	380030	58	405316	17	410828	16
215006	104	321120	47	380034	58	405318	17	410916	16
230010	109	321122	47	380038	58	405320	17	410920	16
250000	151	321124	47	380042	58	405324	17	410924	16
250001	151	321126	47	380046	58	405726	46	411012	16
250002	151	321128	47	380050	58	405820	46	411014	16
250003	151	321130	47	400016N	36	405823	46	411016	16
250004	151	325018	38	400018N	36	405826	46	411018	16
250006	151	325020	38	400020N	36	405828	46	411020	16
250007	151	325022	38	400022N	36	405914	44	411218	43
250008	151	325024	38	400024N	36	405920	44	411326	42
250010	151	325026	38	400026N	36	405924	44	411328	42
250012	151	325028	38	400028N	36	405926	44	411414	16
25001A	151	325030	38	400030N	36	405928	44	411416	16
250104	151	330029	63	400124N	36	406023	30	411522	16
250106	151	330040	63	400128N	36	406029	30	440014	31
250108	151	330140	63	400204	31	406035	46	440016	31
250109	151	330408	73	400206	31	406116	45	440018	31
250111	151	330926	73	400207	31	406130	46	440020	31
250208	151	331025	73	400318N	37	406412	17	440022	31
250210	151	331030	73	400328N	36	406604	45	440024	31
250212	151	331118	73	400428N	37	407020	30	440026	31
250303	152	331228	63	400528	37	407024	30	440028	31
250304	152	331232	63	400528N	36	407028	30	440030	31
250306	152	331328	73	400626N	37	407210	46	440128	32
250310	152	331524	73	400826N	36	407520	30	440225	32
250312	152	331526	73	401534	62	407524	30	440228	32
250416	152	331528	73	403018	40	407528	30	440420	15
250420	152	355210	74	403020	40	409127	30	440422	15
250504	153	355218	74	403022	40	409133	30	440424	15

Ref.	Pag.	Ref.	Pag.	Ref.	Pag.	Ref.	Pag.	Ref.	Pag.
440428	15	461324	27	482522	35	507520	24	606016	10
440520	15	461326	27	482524	35	507522	24	606020	10
440524	15	461328	27	482526	35	507524	24	606022	10
440614	15	461330	27	482528	35	507526	24	606024	10
440616	15	461436	56	482530	35	507528	24	606028	10
440724	32	462024	7	490000	28	507530	24	606112	10
440728	32	462028	7	490022	28	515018	33	606114	10
440828	32	462032	7	490026	28	515020	33	606116	10
440832	32	462036	7	490028	28	515022	33	606216	10
441020	32	462040	7	490030	28	515024	33	606220	10
441024	32	462120	7	490032	28	515026	33	606222	10
441124	32	462124	7	490126	29	515028	33	606224	10
441130	32	462128	7	490230	28	515030	33	606228	10
450016	38	464024	6	495016	34	515128	33	606320	10
450018	38	464028	6	495018	34	515224	33	606324	10
450020	38	464032	6	495020	34	515228	33	606328	10
450022	38	464036	6	495022	34	515328	33	610109	213
450024	38	464120	6	495024	34	515332	33	610115	213
450026	38	464124	6	495026	34	600018	25	610120	213
450028	38	464128	6	495028	34	600020	25	610201	212
450030	38	464218	25	495030	34	600022	25	610202	212
450100	39	464220	25	495114	15	600024	25	610203	212
450226	39	464222	25	495116	15	600026	25	610204	212
450400	95	464224	25	495228	34	600028	25	610415	213
450401	95	464226	25	495324	34	600030	25	610425	213
450402	95	464228	25	495328	34	601514N	27	610425B	213
450403	95	465018	26	495420	15	601518N	27	610425M	213
450404	95	465020	26	495424	15	601520N	27	610425N	213
450405	95	465022	26	495428	15	601522N	27	610903	203
450406	95	465024	26	495520	15	601524N	27	610906	203
450407	95	465026	26	495524	15	601526N	27	610909	203
450530	48	465028	26	495628	34	601528N	27	610912	203
450726	48	465030	26	495632	34	605016	9	610914	203
450820	39	465032	26	500418	41	605018	9	610958	203
450824	39	465123	26	500420	41	605020	9	610959	203
450826	39	465128	26	500422	41	605022	9	610960	203
450828	39	465222	26	500424	41	605024	9	610961	203
450924	39	465226	26	500426	41	605026	9	611002	200
450928	39	465330	27	500428	41	605028	9	611004	200
450932	39	480024	107	500430	41	605032	9	611006	200
450936	39	480027	107	500432	41	605112	9	611010	200
451026	39	480030	107	500436	41	605114	9	611015	200
451126	58	480123	107	500520	41	605116	9	611302	200
451130	58	480126	107	500524	41	605118	9	611304	200
451134	58	480130	107	500528	41	605216	9	611306	200
451138	58	480135	107	500532	41	605218	9	611312	200
451142	58	480140	107	500624	41	605220	9	611358	200
451222	40	480226	108	500628	41	605222	9	611359	200
451226	40	480319	108	500632	41	605224	9	611360	200
451320	40	480321	108	501028	59	605226	9	611361	200
451324	40	480324	108	501032	59	605228	9	611700	215
461010	8	480420	108	501036	59	605232	9	611950	212
461011	8	480528	108	501040	59	605318	9	611951	212
461024	8	480625	107	501046	59	605320	9	611952	212
461028	8	480700	107	505016	35	605322	9	612050	212
461030	8	480723	107	505018	35	605324	9	612051	212
461032	8	480730	107	505020	35	605326	9	612052	212
461036	8	480734	107	505022	35	605328	9	612103	212
461040	8	480740	107	505024	35	605332	9	612104	212
461120	8	480840	107	505026	35	605418	9	612201	203
461124	8	481105	108	505028	35	605420	9	612203	203
461128	8	481110	108	505030	35	605422	9	612206	203
461216	8	481208	108	505126	35	605424	9	612209	203
461318	27	481210	108	505220	35	605426	9	612212	203
461320	27	482518	35	505224	35	605428	9	612303	203
461322	27	482520	35	507518	24	605432	9	612306	203

Ref.	Pag.	Ref.	Pag.	Ref.	Pag.	Ref.	Pag.	Ref.	Pag.
612309	203	624903	205	650130	97	663024	11	681100	334
612312	203	624906	205	650218	96	664016	11	681200	341
620003	206	624910	205	650223	96	665210	13	681300	268
620007	206	624912	205	650226	96	665212	13	681405	160
620012	206	625300	212	651000	96	665214	13	681410	160
620018	206	625406	204	651005	96	665216	13	681500	106
620107	207	625408	204	651006	96	665218	13	681601	96
620212	207	625410	204	651007	96	665220	13	681700	150
620302	200	625506	205	651008	96	665310	13	681800	147
620304	200	625510	205	651009	96	665312	13	681900	328
620306	200	625603	208	651330	63	665314	13	682000	268
620310	200	625706	208	651425	62	665316	13	682103	97
620350	200	625808	210	651430	62	665318	13	682200	135
620351	200	625926	53	651435	62	665614	13	682210	135
620352	200	625930	53	651440	62	665616	13	682250	147
620353	200	626011	204	651616	96	665618	13	682300	175
620407	206	626015	204	651618	96	665814	12	682400	343
620508	210	626103S	220	651620	96	665816	12	682500	314
620712	210	626105B	220	651830	62	665818	12	682600	290
620801	211	626107S	220	651835	62	665820	12	682700	66
620804	211	626110B	220	651840	62	665824	12	682800	356
620806	211	626206L	228	651845	62	666010	12	682900	48
620904	208	626305S	228	651850	62	666012	12	683000	279
621000	211	626307B	228	651860	62	666014	12	683050	279
621005	211	626405	390	652028	57	666016	12	683100	347
621015	211	626410	390	652032	57	666018	12	683210	294
621030	211	626415	390	652034	57	666020	12	683214	294
621040	211	626420	390	652036	57	666118	12	683217	294
621408	207	626430	390	652040	57	666214	12	683300	379
621510	207	626500	389	652045	57	666310	12	683414	339
621612	207	626505	389	652130	56	666312	12	683416	339
621704	205	626510	389	652134	56	666314	12	683418	339
621708	205	626515	389	652138	56	666316	12	683500	349
621908	205	626520	389	652142	56	666424	12	683600	281
621912	205	626530	389	652228	57	680000	314	683700	135
622106	202	626608	206	652232	57	680125	174	683900	280
622109	202	626712	206	652234	57	680130	174	684035	309
622112	202	626811	206	652236	57	680135	174	684050	309
622405	216	626912	210	652240	57	680140	174	684100	278
622603	208	627026	53	652640	97	680200	260	684110	278
622805	208	627030	53	652645	97	680201	260	684120	278
623006	202	627100	57	652735	62	680202	260	684200	350
623009	202	627221	389	652738	62	680203	259	684300	125
623012	202	627227	389	652818	24	680204	260	684400	326
623106	201	627308	210	652820	24	680205	260	684500	340
623109	201	627407	209	652822	24	680206	260	684600	187
623112	201	627511	205	652824	24	680207	260	684700	300
623202	201	627605	387	652826	24	680208	259	684900	319
623203	201	627610	387	652828	24	680209	259	685015	217
623206	201	627615	387	662016	11	680250	260	685022	217
623209	201	627620	387	662018	11	680300	106	685100	217
623212	201	627630	387	662020	11	680301	106	685206	250
623703	204	627705	388	662022	11	680302	106	685210	250
623706	204	627710	388	662024	11	680303	106	685215	250
623710	204	627715	388	662026	11	680304	106	685300	305
623803	217	627720	388	662028	11	680305	106	685350	329
623903	201	627730	388	662032	11	680400	343	685400	348
623906	201	627806	202	662112	11	680500	343	685500	379
623909	201	627809	202	662114	11	680600	334	685602	167
623912	201	627812	202	662116	11	680700	273	685605	167
624003	209	627903	201	662216	11	680700C	273	685607	167
624103	209	627906	201	662220	11	680800	335	685700	294
624204	209	627909	201	662222	11	680900	269	685800	214
624303	209	628002	308	662224	11	681008	255	685900	105
624400	211	628005	308	662228	11	681011	255	685910	105
624500	217	628007	308	662524	11	681015	255	686000	168

Ref.	Pag.	Ref.	Pag.	Ref.	Pag.	Ref.	Pag.	Ref.	Pag.
686010	168	695006	367	701500	140	704700	126	710112	288
686100	176	695007	367	701600	180	704800	126	710116	288
686110	176	695008	367	701712	183	704903	270	710119	288
686200	333	695009	368	701726	183	704904	270	710124	288
686300	328	695010	368	701734	183	704904C	269	710129	288
686400	328	695011	370	701830	183	704905	270	710300	359
686500	120	695012	370	701910	168	704906	270	710400	359
686600	245	695013	373	702026	167	704909	270	710401	359
686700	245	695014	373	702032	167	704910	271	710500	359
686710	245	695015	368	702036	167	704911	270	710600	359
686720	245	695016	368	702110	214	704912	271	710700	359
686730	245	695017	368	702225	167	704913	271	710800	359
686800	347	695018	369	702236	167	705005	307	710900	359
686900	347	695019	369	702241	167	705105	307	711020	287
687000	315	695020	371	702310	341	705205	307	711114	287
687110	309	695021	371	702400	146	705210	271	711124	287
687215E	166	695022	371	702500	146	705300	269	711224	392
687215M	166	695023	371	702700	146	705312	20	711320	378
687300	231	695024	371	702800	216	705312	203	711414	378
687400	128	695025	371	702900	216	705320	20	711503	392
687507	312	695026	370	703007	300	705324	20	711620	289
687600	277	695027	372	703008	300	705328	20	711700	313
687730	108	695028	370	703010	300	705510	21	711807	325
687735	108	695029	370	703012	300	705520	21	711807	377
687800	327	695030	372	703014	300	705530	21	711809	325
687900	241	695031	372	703015	300	705610	315	711809	377
687901	241	695032	369	703016	300	705706	276	711810	325
687902	241	695033	369	703018	300	705710	276	711810	377
687903	241	695034	372	703020	300	705810	218	711812	377
687904	241	695035	372	703022	300	705920	286	711816	377
687905	241	695036	370	703025	300	705925	286	711820	377
687906	241	695037	374	703200	216	706020	286	711826	377
687907	241	695038	374	703206	216	706025	286	712000	312
687908	241	695039	369	703500	146	706250	134	712100	130
687909	241	695040	366	703625	296	706300	325	712150	130
687910	241	695041	369	703630	296	706400	162	712200	304
687911	241	695042	377	703714	20	706550	323	712800	360
688000	242	695043	367	703719	20	706600	180	712900	360
688001	242	695044	367	703724	20	706850	341	713000	360
688002	242	695045	367	703728	20	706900	316	713100	360
688003	242	695046	377	703807	300	707150	115	713200	360
688004	242	699900	238	703810	300	707700	133	713302	309
688005	242	699910	238	703812	300	707900	328	713405	364
688006	242	700001	306	703815	300	708200	344	713410	364
688007	242	700002	306	703818	300	708250	344	713610	364
688008	242	700105	307	703820	300	708450	161	713705	364
688009	242	700107	307	703907	301	708534	317	713710	364
688010	242	700112	307	703910	301	708544	317	713810	364
688011	242	700201	306	703915	301	708700	298	713830	66
688100	267	700202	306	704007	300	708706	298	713900	297
688200	330	700203	306	704008	300	708710	298	713914	297
690014	300	700204	306	704009	300	708800	284	714000	298
690018	300	700308	391	704010	300	708933	187	714100	298
690108	299	700309	391	704012	300	709100	368	714219	296
690115	299	700311	391	704014	300	709200	129	714223	296
690122	299	700512	298	704016	300	709209	129	714227	296
690124	299	700600	254	704018	300	709320	302	714231	296
690132	299	700700	377	704020	300	709400	350	714237	296
690138	299	700825	289	704129	301	709422	350	714243	296
690233	299	700830	289	704216	169	709500	175	714319	295
695000	366	700835	289	704220	169	709703	307	714323	295
695001	366	700840	289	704225	169	709705	307	714327	295
695002	370	700900	53	704329	296	709710	307	714331	295
695003	366	700950	53	704400	125	710030	289	714337	295
695004	366	701117	309	704450	125	710035	289	714343	295
695005	366	701400	168	704500	126	710040	289	714400	306

Ref.	Pag.	Ref.	Pag.	Ref.	Pag.	Ref.	Pag.	Ref.	Pag.
714401	306	716816	301	722808	135	728200	327	733000	142
714522	392	716818	301	722900	294	728310	259	733100	143
714620	287	716820	301	723008	98	728320	259	733400	335
714624	287	716906	99	723100	333	728502	186	733600	283
714720	287	716908	99	723150	333	728600	332	733700	378
714800	246	716910	99	723200	317	728750	315	733750	378
714805	246	717008	288	723300	294	728914G	254	733804	361
714810	246	717012	288	723400	139	728914P	254	733806	361
714850	246	717014	288	723401	139	728922G	254	733900	358
714855	246	717016	288	723402	139	728923	183	733901	358
714860	246	717018	288	723500	148	728927	183	733902	358
714900	247	717020	288	723650	343	728932	183	733903	358
714950	246	717022	288	723700	148	729011	183	734050	356
715003	247	717025	288	723800	148	729021	183	734051	356
715005	247	717030	288	723900	146	729026	183	734052	356
715010	247	717130	177	724000	140	729029	183	734053	356
715110	247	717216	98	724100	140	729204	185	734054	356
715210	247	717300	98	724200	329	729307	185	734200	129
715310	247	717310	98	724450	283	729308	185	734300	301
715311	247	717700	339	724500	312	729400	301	734310	301
715312	248	717800	339	724600	312	729500	183	734314	301
715313	248	718007	101	724700	312	729501	183	734600	161
715314	248	718106	101	724912	295	729502	184	734700	143
715315	248	718210	330	724917	295	729510	184	734810	161
715429	243	718300	301	725012	295	729511	184	734900	143
715433	243	718508	100	725017	295	729520	184	735000	186
715437	243	718510	100	725033	187	729521	184	735000	173
715518	286	718710	99	725100	339	729600	146	735500	157
715520	286	719106	358	725200	176	729900	335	735700	148
715526	286	719110	358	725200	176	730000	97	735800	344
715530	286	719600	295	725300	290	730100	293	735900	178
715630	66	719800	133	725404	280	730210	263	735901	178
715719	296	720006	222	725610	283	730310	169	735903	178
715723	296	720106	222	725712	100	730420	117	735904	178
715727	296	720200	392	725910N	14	730514	288	735905	180
715731	296	720200	392	725910R	14	730518	288	735907	178
715737	296	720305	222	725913R	14	730520	288	735908	178
715826	296	720307	222	725921R	14	730522	288	735909	179
715830	296	720407	222	725924R	14	730526	288	735910	179
715932	289	720500	392	726015N	14	730530	288	735911	179
716004	99	720607	222	726015R	14	730610	274	735912	179
716005	99	720610	222	726027R	14	730710	322	735913	179
716006	99	720614	392	726200	272	730818	52	735914	179
716007	99	720616	392	726210	272	730824	52	736000	182
716008	99	720618	392	726300	314	730826	52	736001	182
716009	99	720620	392	726500	98	730828	52	736002	182
716009	99	720700	305	726618	160	730907	312	736003	182
716010	99	720920	219	726624	160	730909	312	736100	181
716012	99	721010	261	726800	328	730911	312	736101	181
716020	99	721010R	261	727020	126	731200	187	736200	229
716024	99	721011R	261	727060	125	731210	187	736300	173
716050	99	721110	261	727220	302	731300	293	736600	148
716090	99	721221	20	727300	378	731400	321	736700	316
716106	99	721600	305	727350	378	731500	216	736800	168
716107	99	721700	327	727500	48	731600	313	736900	168
716108	99	721707	96	727608	272	731702	307	737000	180
716109	99	721708	96	727608P	272	731705	307	737200	180
716110	99	721820	287	727612	272	731707	307	737401	181
716112	99	721917	287	727612P	272	731710	307	737450	181
716250	254	722013	287	727615	272	732300	317	737504	185
716300	317	722224	295	727650	272	732400	173	737600	181
716410	318	722310	100	727708	100	732500	173	737700	180
716513	348	722400	295	727808	100	732600	173	737810	163
716518	348	722500	370	727908	100	732700	188	737810E	165
716730	350	722600	340	727910	100	732800	188	737815	163
716732	350	722708	99	728000	315	732900	143	737815E	165
716740	350	722712	99	728100	288				

Ref.	Pag.	Ref.	Pag.	Ref.	Pag.	Ref.	Pag.	Ref.	Pag.
737820	163	741203	235	745330	315	748000	324	751530	347
737820E	165	741316	117	745335	315	748001	324	751610	291
737825	163	741407	233	745439	315	748002	324	751703	221
737825E	165	741410	233	745500	292	748110	234	751705	221
737830	163	741412	233	745605	307	748115	234	751800	167
737830E	165	741508	215	745610	307	748200	258	751823	52
737910	163	741600	290	745700	261	748300	312	751900	325
737910E	165	741700	267	745803	234	748400	268	751910	325
737915	163	741824	316	745805	234	748401	268	751918	52
737915E	165	741830	316	745807	234	748410	269	752050	340
737920	163	741900	319	745810	234	748450	268	752109	349
737920E	165	742000	216	745903A	220	748451	268	752118	349
737925	163	742200	169	745903V	220	748500	215	752209	349
737925E	165	742300	346	745905A	220	748550	215	752302	308
737930	163	742420	302	745905V	220	748601	298	752305	308
737930E	165	742424	302	746004R	220	748602	298	752400	185
738000	163	742500	137	746004V	220	748700R	186	752550	167
738000E	165	742501	137	746005R	220	748700V	186	752600	374
738100	164	742600	172	746005V	220	748800	166	752734	159
738100E	165	742601	172	746100	292	748900	318	752740	159
738200	185	742700	172	746200	111	749000	332	752745	159
738300	164	742800	332	746300	67	749050	333	752750	159
738300E	166	742905	365	746400	323	749100	256	752755	159
738400	163	742908	365	746450	323	749110	256	752760	159
738400E	165	742915	365	746500	103	749200	132	752850	101
738450	163	743028	345	746505	103	749300	320	752900	189
738450E	165	743033	345	746509	103	749400	244	752900	119
738500	164	743040	345	746630	346	749430	243	753202	308
738500E	166	743100	383	746650	323	749433	243	753205	308
738600	188	743221	21	746700	275	749433A	244	753385	256
738700	357	743300	305	746800	262	749433R	244	753401A	253
738750	357	743400	303	746902	308	749433V	243	753401G	253
738760	356	743401	303	746905	308	749433Y	244	753406G	256
738770	43	743402	303	747000	275	749438	243	753406P	256
738800	314	743403	303	747001	275	749600	332	753408G	256
738900	125	743404	303	747100	381	749727	282	753408P	256
739000	334	743405	304	747210	365	749800	292	753450	253
739001	334	743406	303	747220	365	749924	294	753455	253
739002	334	743407	283	747230	365	749928	294	753500R	330
739100	262	743408	283	747340	345	750000	328	753620	349
739200	304	743409	304	747422	346	750100	305	753630	349
739300	175	743410	304	747425	346	750225	174	753700	321
739500	184	743411	283	747430	346	750230	174	753801	232
739614	326	743500	306	747515	346	750235	174	753802	232
739801	376	743510	306	747522	346	750240	174	753802C	232
739850	266	743550	306	747522R	348	750350	267	753803	233
739901	365	743560	306	747530	346	750415	174	753805	233
740000	365	743600	261	747530R	348	750515	174	753805C	232
740101	363	743700	329	747625	346	750600	269	753807	233
740111	363	743850	364	747625R	348	750710	218	753810	233
740202	363	743875	364	747630	346	750720	218	753812	233
740205	363	743900	311	747630R	348	750805	127	753821	232
740310	363	744010	382	747635R	348	750900	109	753903	234
740438	258	744100	382	747640R	348	750902	127	753904	234
740455	258	744200	292	747730	346	750905	127	753906	233
740500	362	744300	318	747734	347	750910	127	753908	233
740700	111	744400	282	747830	346	751000	127	753910	233
740800	318	744500	156	747830R	348	751050	127	754000	123
740821	318	744600	326	747918	346	751123	316	754110	250
740830	318	744700	158	747920	348	751215	308	754120	250
740900	313	744800	381	747930	348	751230	308	754410	285
740921	313	744900	294	747940	378	751250	308	754420	285
741016	318	745000	318	747950	136	751315	308	754500	196
741021	318	745100	317	747951	136	751325	308	754510	256
741100	309	745200	383	747952	136	751350	308	754701	250
741202	235	745325	315	747953	136	751430	347	754704	248

Ref.	Pag.	Ref.	Pag.	Ref.	Pag.	Ref.	Pag.	Ref.	Pag.
754709	248	757800	362	758704	234	762038	354	768600	310
754709A	249	757905E	221	758706	234	762039	355	768700	310
754710	248	758000	167	758814	235	762040	355	768710	310
754716	248	758104B	221	758818	235	762041	355	768715	310
754750	250	758105B	221	758910G	220	762042	355	768800	311
754804	248	758205G	221	758910P	220	762043	355	768910	336
754807	248	758207G	221	759000	361	762044	355	769000	329
754810	248	758328	229	759100	361	762045	355	769100	377
754810A	249	758328B	229	759200	361	762046	355	769200	312
754900	82	758341	229	759300	361	762047	354	769500	129
755000	281	758341B	229	759701	360	762048	354	769745	391
755000P	281	758403	224	759702	360	762049	352	769800	326
755001	308	758405	224	759801	375	762050	354	769911	310
755002	308	758410	225	759803	375	762051	352	770100	391
755005	308	758435	225	759811	375	762052	352	770200	391
755010	308	758435A	225	759812	375	762910	223	770250	391
755050	281	758435B	225	759813	375	762920	223	770500	177
755050P	281	758435C	225	759900	375	762930	223	771100	132
755100	310	758435D	225	760030	158	762940	223	771200	322
755101	250	758435E	225	760030E	158	762950	223	771400	158
755104	248	758435F	225	760040E	158	763150	319	771700	177
755106	248	758435G	225	760045	158	763300	304	771800	177
755108	248	758435H	225	760055	158	763450	327	771900	157
755108A	249	758435I	224	760055E	158	763600	316	772100	344
755150	250	758435K	225	760245	158	763740	124	772300	264
755200	310	758435N	225	760400B	155	763760	124	772400	263
755300	311	758435O	225	760603	155	763800	326	772500	266
755305	311	758435P	225	760604	155	763900	166	772600	266
755400	311	758435R	225	760700	156	764000	375	772700	357
755405	311	758435U	225	760900	216	764001	375	772800	357
755500	311	758435V	225	761000	169	764002	375	772900	357
755505	311	758435Z	225	761003	169	764006	375	773000	357
755600	301	758450	225	761100	168	764010	375	773050	357
755726	235	758450A	226	761200	317	764011	375	773100	280
755748	235	758450AA	227	761400	318	764012	375	773216	339
755833	348	758450B	226	761500	164	764022	375	773221	339
755918	347	758450C	227	761600	216	764024	375	773231	339
756000	167	758450D	226	761900	335	764140	124	773316	338
756200	162	758450E	227	762010	351	764145	124	773321	338
756300	156	758450F	227	762011	351	764150	124	773331	338
756450	121	758450G	226	762012	351	764155	124	773416	338
756500	186	758450H	226	762013	351	764160	124	773421	338
756600	269	758450I	226	762014	352	764200	180	773431	338
756650	269	758450J	226	762015	351	764410	361	773510	133
756700	132	758450K	227	762016	352	764412	361	773512	133
756830	160	758450L	227	762017	352	764540	360	773602	101
756835	160	758450M	226	762018	353	764550	360	773606	101
756840	160	758450N	227	762019	352	764650	271	773608	101
756845	160	758450O	226	762020	353	764700	235	773740	158
756850	160	758450P	226	762021	353	764838	285	773755	158
756860	160	758450Q	227	762022	353	764870	285	773800	276
756950	81	758450R	226	762023	353	765100	129	773810	276
757004	249	758450S	226	762024	353	765200	169	773820	276
757006	249	758450T	226	762025	351	765320	302	773901	160
757010	249	758450U	227	762026	352	765324	302	773902	160
757015	249	758450V	226	762027	353	765400	285	773904	160
757100	167	758450W	226	762028	354	765410	285	773907	160
757203	249	758450X	227	762029	354	765500	289	774016	117
757205	249	758450Y	227	762030	353	765615	231	774100	292
757208	249	758450Z	227	762031	353	765700	289	774200	280
757212	249	758475	225	762032	354	765800	341	774300	130
757300	362	758475C	224	762033	355	765950	379	774350	130
757400	169	758510	325	762034	354	768200	270	774356	130
757505P	221	758606	231	762035	354	768300	157	774503	135
757600	362	758609	231	762036	354	768414	320	774504	147
757700	362	758612	231	762037	352	768500	310	774505	147

Ref.	Pag.	Ref.	Pag.	Ref.	Pag.	Ref.	Pag.	Ref.	Pag.
774516	339	780730	176	786206	162	789000	139	793502	121
774521	339	780825	176	786209	162	789006	140	793503	121
774531	339	780900	378	786214	162	789007	139	793600	383
774610	131	781000	379	786215	162	789009	142	793700	149
774700	304	781100	369	786300N	161	789010	141	793800	149
774710	265	781200	149	786301N	161	789100	196	793900	262
774801	150	781400	319	786302N	161	789200	196	794000	333
774950	223	781500	319	786303N	161	789250	196	794117	277
774951	223	781700	176	786304N	161	789300	177	794122	277
774952	223	781810	134	786305N	161	789301	177	794200	137
774953	223	781900	342	786306N	161	789310	177	794201	137
774954	223	782000	263	786307N	161	789440	159	794202	137
774955	223	782110	214	786308N	161	789600	196	794302	149
774956	223	782310	314	786309N	161	789750	109	794303	149
774957	223	782410	314	786510	82	789800	263	794304	148
774958	223	782500E	345	786511	82	789904	229	794400	145
774959	223	782501E	345	786515	82	790100	156	794550	129
775035	231	782502E	345	786600	125	790300	309	794600	141
776210	110	782505	345	786725	171	790400	338	794700	141
776310	109	782650	52	786730	171	790402	251	794800	144
776400	264	782750	293	786800	173	790402E	252	794900	144
776500	133	782800	157	786922	320	790406	251	795000	141
776600	284	782912	290	787020	191	790408	251	795001	142
776700	118	783016	337	787025	191	790408E	252	795100	381
776800	147	783024	337	787030	191	790410	251	795250	383
776900	341	783120	337	787035	191	790410E	252	795400	122
777000	134	783124	337	787040	191	790412	251	795500	322
777000E	134	783300	329	787045	191	790412E	252	795612	308
777150	264	783400	122	787125	191	790415	251	795625	308
777200	324	783450	122	787130	191	790415E	252	795650	308
777201	324	783620	337	787135	191	790420	251	795700	124
777300	293	783626	337	787140	191	790420E	252	795800	124
777400	344	783700	331	787145	191	790423	251	795900	284
777500	321	783750	331	787225	191	790423E	252	796000	313
777510	321	783760	331	787230	191	790432	251	796127	320
777609	323	783770	331	787300	189	790432E	252	796200	330
777702	322	783950	123	787310	189	790500	326	796300	113
777800	264	784000	291	787410	170	790600	98	796400	262
778000	164	784100	291	787500	133	790800	161	796500	168
778110	214	784150	291	787600	130	790900	118	796600	330
778200	215	784200	138	787701	131	790910	118	796711	342
778333	66	784201	138	787800	102	790920	118	796721	342
778400	376	784202	138	787900	329	791125	316	796900	230
778450	376	784203	138	788000	115	791130	316	796905	230
778600	338	784204	138	788100	117	791135	316	796933A	230
778800	132	784206	138	788219	189	791200	194	796933D	230
778900	321	784208	138	788223	189	791400	332	796933I	230
779000	322	784338	66	788300	189	791600	381	796933P	230
779010	322	784340	66	788402	192	791700	381	796933R	230
779100	268	784400	89	788403	193	791800	113	796933V	230
779101	268	784700	368	788405	192	792050	189	796950	230
779200	336	784900	373	788406	193	792100	140	796950A	230
779400	278	785100	374	788407	192	792200	111	796950D	230
779401	278	785250	384	788408	192	792300	128	796950I	230
779510	320	785300	374	788409	193	792400	382	796950P	230
779700	336	785400	374	788411	193	792500	159	796950R	230
779750	336	785500	384	788500	314	792600	110	796950V	230
779900	148	785600	384	788604	255	792650	110	797000	290
780010	219	785700	384	788605	255	792900	150	797105	255
780020	219	785800	319	788619	255	793000	145	797109	255
780030	219	786000	376	788710	255	793050	145	797112	255
780100	219	786050	376	788720	255	793100	150	797119	255
780110	219	786075	376	788736	255	793300	266	797200	298
780310	340	786100	373	788800	369	793400	126	797210	299
780410	340	786201	162	788902	144	793500	120	797220	299
780510	356	786203	162	788903	144	793501	120	797250	298

Ref.	Pag.	Ref.	Pag.	Ref.	Pag.	Ref.	Pag.	Ref.	Pag.
797300	257	812501	385	820412	94	827800	86	870033	80
797301	257	812502	385	820501	89	827920	87	870039	80
797302	257	812503	385	820502	92	827921	87	870040	80
797303	257	812504	385	820510	89	827926	87	870041	80
797304	258	812505	385	820622	90	828000	87	870042	80
797305	257	812506	385	820724	92	828110	94	870043	80
797306	258	812507	386	820920	88	828340	63	870424	274
797310	258	812508	386	820926	88	828400	87	870428	274
797311	258	812509	386	821024	85	828637	65	870500	380
797312	258	812510	386	821600	92	828800	94	870550	380
797500	272	812513	386	821700	92	828914	110	870600	380
797600	218	812518	386	821812	94	828918	110	870650	380
797710	338	812519	386	821824	90	835012	84	870820	79
797810	215	812520	386	821928	65	835125	84	870926	79
797812	215	812521	386	821932	65	835130	84	871300	188
797814	215	812522	385	822028	65	835231	84	871406	186
797902	307	812523	385	822033	65	835235	84	871600	82
798100	131	815015	190	822037	65	835320	84	871700	83
798400	391	815025	190	822040	65	835324	84	871800	83
798410	391	815030	190	822141	91	835328	84	871900	83
798500	282	815110	190	822236	65	835330	84	872000	82
798640	159	815115	190	822239	65	835424	84	872201	195
798700	132	815120	190	822530	91	835426	84	872202	195
798714	132	815125	190	822630	91	835539	84	872203	195
798800	111	815130	190	822823	90	840026	70	872204	195
798900	142	815135	190	822912	94	840126	70	872206	195
799000	272	815212	190	823036	90	840230	70	872207	194
799100	119	815215	190	823200	89	840324	70	872208	194
799210	171	815220	190	823410	93	840500	71	872209	194
799220	171	815225	190	823528	90	840634	70	872210	195
799230	171	815230	190	823624	91	840728	70	872400	185
799240	171	815320	191	823926	92	840826	71	872500	83
799300	113	815326	191	824121	90	840935	71	873000	117
799301	113	815425	191	824228	88	841041	71	873200	273
799302	113	815520	191	824328	88	850000	110	875001	76
799304	112	815634	191	824426	92	850100	81	875125	76
799305	112	815715	190	824511	94	850200	113	875130	76
799400	112	815720	190	824600	93	850300	116	875228	76
799401	112	815725	190	824608	93	850310	116	875322	76
799402	112	815730	190	824700	93	850320	116	875424	76
799403	112	820110	88	824701	93	860021	79	875520	76
799404	112	820110	94	824703	93	860301	114	875526	76
799405	112	820112	88	824802	89	860303	114	875600	76
799510	337	820112	94	824803	89	860305	114	875700	77
799600	336	820114	88	824804	89	860307	114	875712	77
799700	335	820116	88	824910	87	860311	115	875719	77
799820	277	820118	88	825016	91	860312	115	875800	77
799904	229	820120	88	825020	91	860314	114	875900	77
799904A	229	820122	88	825603	92	860315	116	876000	78
799904R	229	820124	88	825924	85	860400	119	876050	78
800122	103	820126	88	826022	85	860500	116	901008	413
800124	103	820128	88	826426	88	860609	379	901118	409
800126	103	820130	88	826517	85	860621	379	901120	409
801000	149	820224	91	826524	85	865000	81	901122	409
802000	97	820226	91	826628	85	865050	81	901124	409
802200	103	820228	91	826712	92	870001	79	901126	409
802300	97	820308	88	826716	92	870004	78	901128	409
802428	65	820308	94	826900	90	870005	78	902624	413
810400	52	820314	88	827000	90	870006	79	902626	413
810525	103	820314	94	827130	85	870007	79	902712	411
810530	103	820320	88	827250	91	870008	78	902812	412
810535	103	820325	88	827300	86	870009	79	902910	411
810628	65	820330	88	827400	86	870010	79	903000	408
810635	65	820335	88	827500	86	870012	80	903005	408
810639	65	820408	94	827600	182	870018	80	903007	408
812500	385	820410	94	827700	86	870024	79	903008	408

Ref.	Pag.	Ref.	Pag.	Ref.	Pag.	Ref.	Pag.	Ref.	Pag.
903132	409	908118	404	912936	409	930014C	50	942006	393
903210	410	908120	404	913010	406	930014D	50	942100	397
903308	397	908122	404	914534	17	930014E	50	942101	397
903311	411	908124	404	914538	17	930014F	50	942102	397
903314	411	908126	404	914542	17	930116	18	942103	397
903425	409	908128	404	914618B	19	930120	18	942104	397
903522	410	908224	405	914618M	19	930124	18	942105	397
903524	410	908312	402	914618N	19	930128	18	942200	398
903812	410	908314	402	914618P	19	930216	18	942201	398
903814	412	908316	402	914618T	19	930220	18	942202	398
903925	409	908320	402	914618V	19	930224	18	942203	398
903930	409	908405	402	914622N	19	930228	18	942204	398
903935	409	908501	405	915012	18	930314	18	942205	398
903940	409	908612	403	915014	18	930316	18	961224T	51
904012	409	908725	404	915016	18	931624	51	970712	297
904114	410	908730	404	915018	18	931624T	51	970714	297
904116	410	908736	404	916318	51	935010	395	970716	297
904118	410	908805	405	916320	51	935122	395	970718	297
904122	411	908906	404	916322	51	935124	395	970720	297
904124	411	908909	404	916324	51	935126	395	970722	297
904212	411	909010	404	916326	51	935128	395	970724	297
904214	411	909114	403	916328	51	935208	395	970726	297
904216	411	909210	403	916526	51	935332	395	970728	297
904220	411	909308	397	916528	51	935410	396	970730	297
904301	412	909311	406	916530	51	935508	397	970732	297
904302	412	909314	406	916532	51	935511	395	970736	297
904410	409	909407	403	916726	51	935514	395	970800	297
904500	410	909408	403	916728	51	935625	395	970805	297
904609	412	909512	404	916732	51	935724	395	970810	297
904707	413	909612	403	916736	51	935812	396	970815	297
904708	413	909814	405	916740	51	935930	396	970914	297
904808	411	909818	405	917130	59	935935	396	970916	297
905015	408	909932	406	917134	59	936012	396	970918	297
905017	408	910015	405	917138	59	936114	396	970920	297
905020	408	910103	401	917142	59	936212	396	970922	297
905022	408	910132	405	918508	400	936214	396	970924	297
905027	408	910145	401	918632	400	936312	399	970926	297
905116	409	910210	401	918710	400	936422	396	970928	297
905120	409	910222	404	918807	400	936509	396	970930	297
905124	409	910250	401	919225	400	936610	396	970932	297
905232	408	910350	401	919322	400	936722	396	970936	297
905300	412	910370	401	920018	415	936724	396	971600	296
905437	409	910410	401	920022	414	936728	396	971612	297
905608	413	910550	401	920024	414	941600	399	971614	297
905612	413	910650	401	920308	414	941601	399	971616	297
905614	413	910815	401	920414	414	941602	399	971618	297
905713	413	911006	400	920514	414	941603	399	971620	297
905800	413	911008	400	920614	414	941604	399	971622	297
905924	402	911010	400	920716	414	941605	399	971624	297
905926	402	911422	412	921025	414	941606	399	971626	297
906214	413	911514	401	921030	414	941607	399	971628	297
907108	405	911522	401	921036	414	941650	399	971630	297
907214	405	911806	410	921106	415	941651	399	971632	297
907300	406	911809	410	921109	415	941652	399	975500	415
907407	402	911850	410	921210	415	941653	399	980032	48
907408	402	911910	410	921405	414	941654	399	CC02	127
907512	402	912214	400	921600	415	941655	399	CCA01	127
907514	402	912218	400	921700	415	941656	399	CG02	127
907634	403	912518	412	925008	407	941657	399	CH01	127
907700	406	912612	18	925108	407	941658	399	CNW0102	127
907800	404	912614	18	925210	407	942000	393	CPA01	127
907932	406	912616	18	925301	407	942001	394		
908022	404	912922	409	925414	407	942002	394		
908024	404	912924	409	925510	407	942003	394		
908028	404	912928	409	930014A	50	942004	393		
908032	404	912932	409	930014B	50	942005	393		





SINCE
• 1942 •

